

ENERGIZER EN22

9V

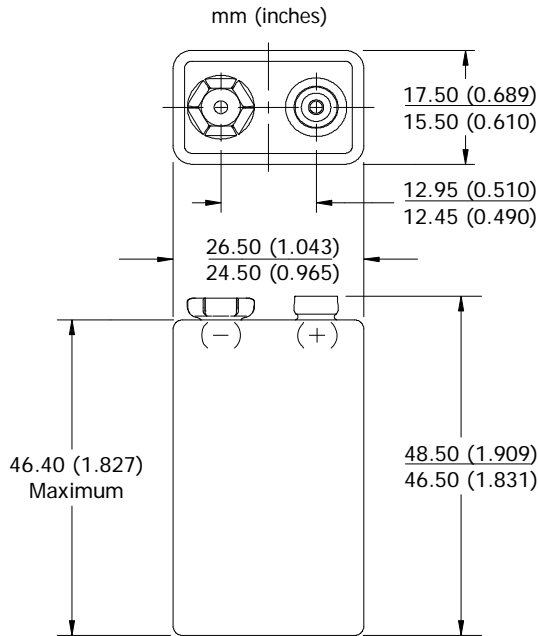

Industry Standard Dimensions



Specifications

NOT INTENDED FOR RETAIL TRADE

- Classification:** Alkaline
- Chemical System:** Zinc-Manganese Dioxide (Zn/MnO₂)
No added mercury or cadmium
- Designation:** ANSI-1604A, IEC-6LR61
- Nominal Voltage:** 9.0 volts
- Operating Temp:** -18°C to 55°C (0°F to 130°F)
- Typical Weight:** 45.6 grams (1.6 oz.)
- Typical Volume:** 21.1 cubic centimeters (1.3 cubic inch)
- Jacket:** Metal
- Shelf Life:** 5 years at 21°C (80% of initial capacity)
- Terminal:** Miniature Snap

Milliamp-Hours Capacity

Continuous discharge to 4.8 volts at 21°C

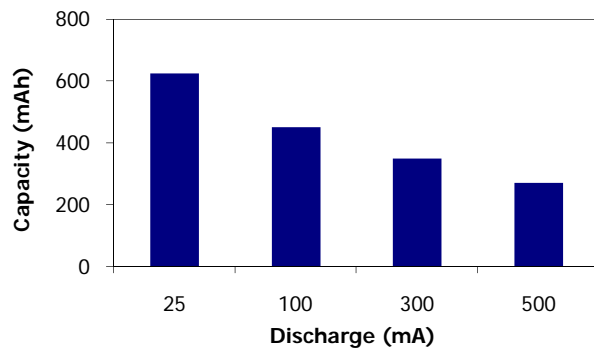

Constant Resistance Performance

Typical Characteristics (21°C)

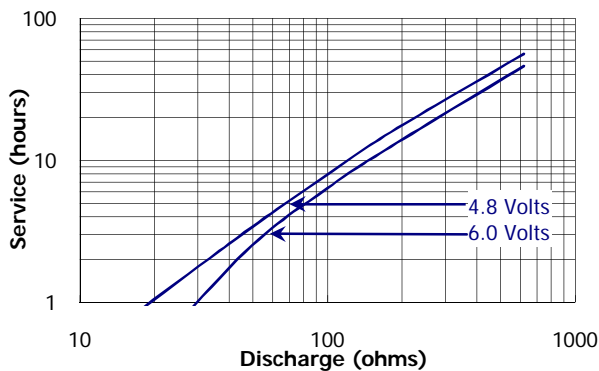

Constant Current Performance

Typical Characteristics (21°C)

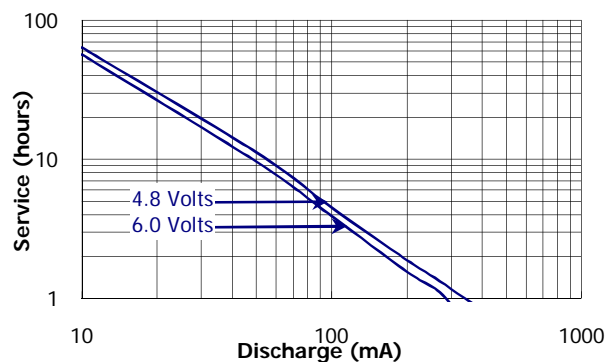

Important Notice

This datasheet contains typical information specific to products manufactured at the time of its publication.
©Energizer Holdings, Inc. - Contents herein do not constitute a warranty.

ENERGIZER EN22

9V

Industry Standard Tests (21°C)

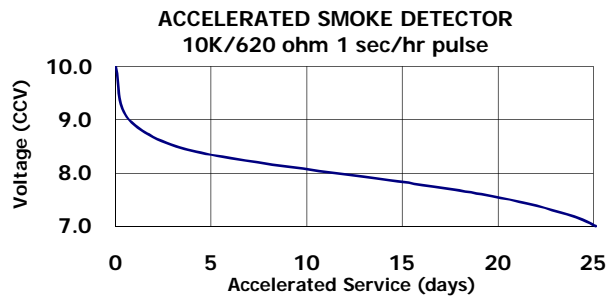
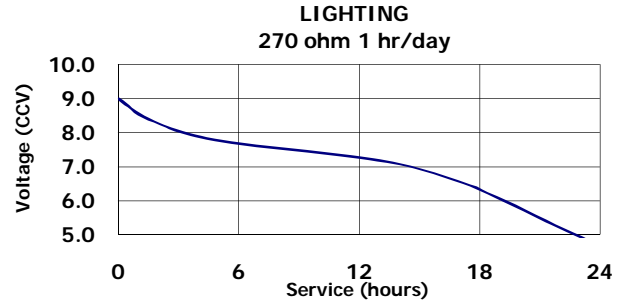
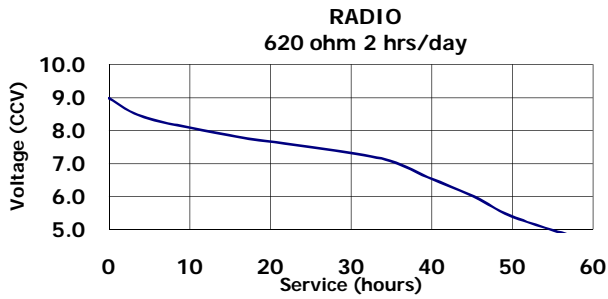

Important Notice

This datasheet contains typical information specific to products manufactured at the time of its publication.
©Energizer Holdings, Inc. - Contents herein do not constitute a warranty.