

ENERGIZER NO. CR2016

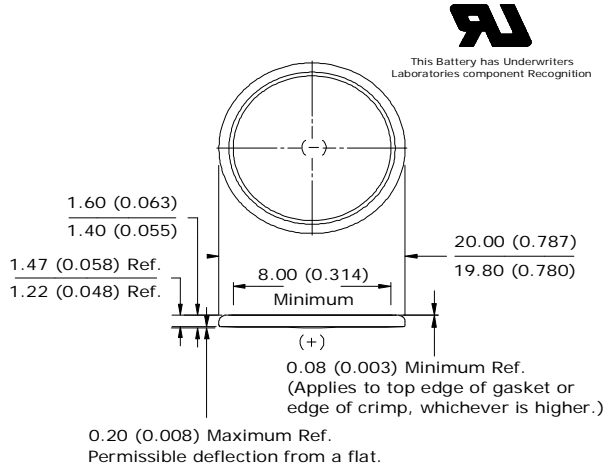

Industry Standard Dimensions

mm (inches)



Simulated Application test

Typical Performance at 21°C (70°F)

Schedule:	Typical Drains: at 2.9V (mA)	Load (ohms)	Cutoff 2.0V (hours)
Continuous	0.097	30,000	928

Typical Discharge Characteristics

Load: 30K ohms - Continuous
Typical Drain @ 2.9V: 0.097 mA

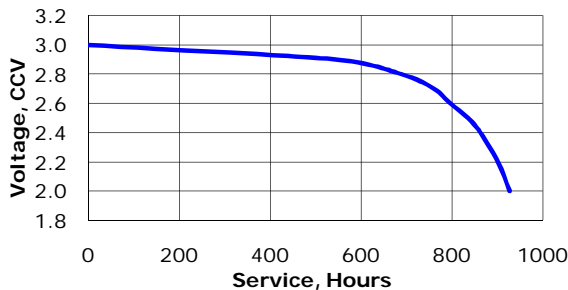

Specifications

- Classification:** "Lithium Coin"
- Chemical System:** Lithium / Manganese Dioxide (Li/MnO₂)
- Designation:** ANSI / NEDA-5000LC, IEC-CR2016
- Nominal Voltage:** 3.0 Volts
- Typical Capacity:** 90 mAh (to 2.0 volts)
(Rated at 30K ohms at 21°C)
- Typical Weight:** 1.9 grams (0.07 oz.)
- Typical Volume:** 0.5 cubic centimeters (0.03 cubic inch)
- Max Rev Charge:** 1 microampere
- Energy Density:** 122 milliwatt hr/g, 464 milliwatt hr/cc
- Typical Li Content:** 0.036 grams (0.0013 oz.)
- UL Listed:** MH12454
- Shipping:** For complete details, please reference:
Global (except US): Special Provision A45 of the International Air Transport Association Dangerous Goods Regulations
United States: 49 CFR 173.185

Cross Section

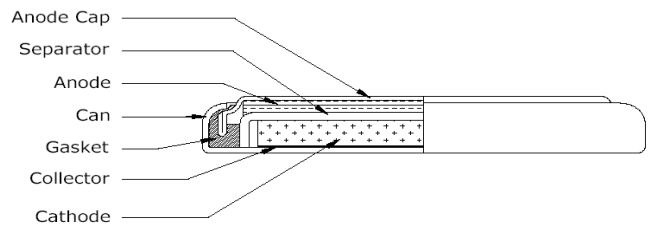

Internal resistance Characteristics

Pulse Test at 21°C (70°F)

Bkgnd Drain: Continuous
30K ohms
0.097 mA @ 2.9V

Pulse Drain: 2 seconds X 12 times/day
400 ohms
6.8 mA @ 2.7V

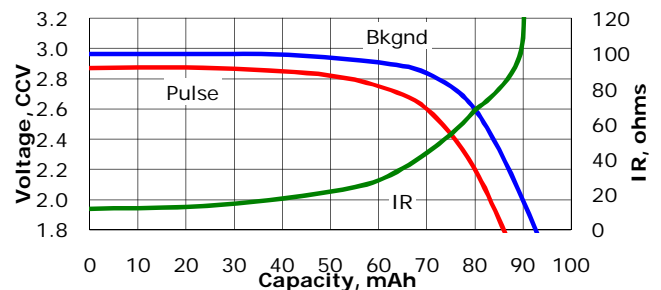

Important Notice

This datasheet contains typical information specific to products manufactured at the time of its publication.
©Energizer Holdings, Inc. - Contents herein do not constitute a warranty.