

ENERGIZER L91

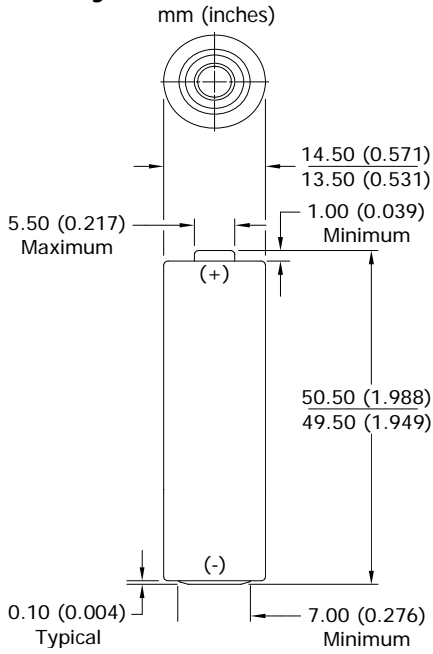

Industry Standard Dimensions



This battery has Underwriters Laboratories component recognition (MH29980)

Specifications

Classification:	"Cylindrical Lithium"
Chemical System:	Lithium/Iron Disulfide (Li/FeS ₂)
Designation:	ANSI 15-LF, IEC-FR6
Nominal Voltage:	1.5 Volts
Typical Weight:	14.5 grams (0.5 oz.)
Typical Volume:	8.0 cubic centimeters (0.5 cubic inch)
Max Discharge:	2.0 Amps Continuous
(single battery only)	3.0 Amps Pulse (2 sec on / 8 sec off)
Typical Li Content:	0.98 grams (0.03 oz.)
Typical IR:	90 to 150 milliohms*
Shelf Life:	15 years at 21°C (90% of rated capacity)
Transportation:	For complete details, please reference:
Global (except US):	Special Provision A45 of the International Air Transport Association Dangerous Goods Regulations
United States:	49 CFR 173.185

* For additional information, please reference the [IR technical white paper](#).

Milliamp-Hours Capacity

Constant Current Discharge to 0.9 Volts at 21°C

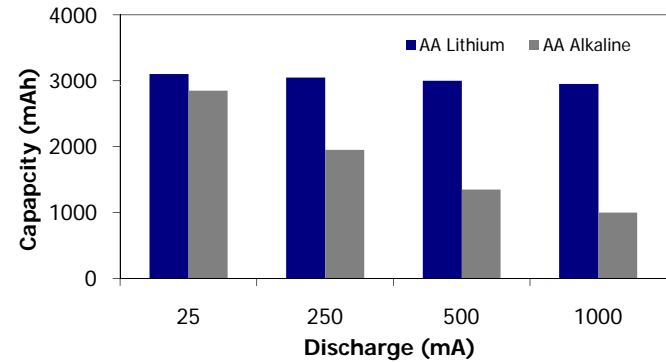

Milliwatt-Hours Capacity at Cold/Room Temperature

Constant Power Discharge to 1.0 Volts at 0°C and 21°C
Recommended Lithium Operating/Storage Temperature: -40°C to 60°C

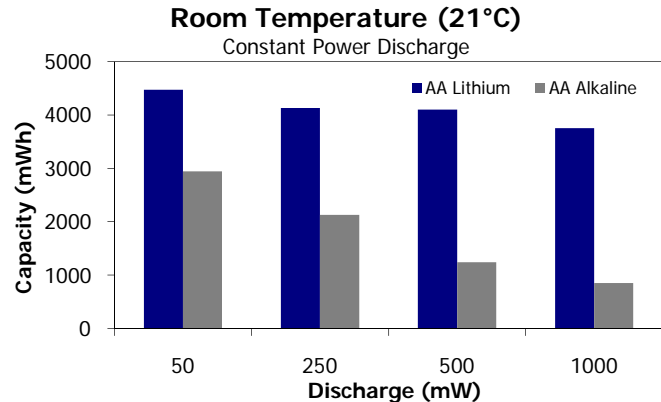
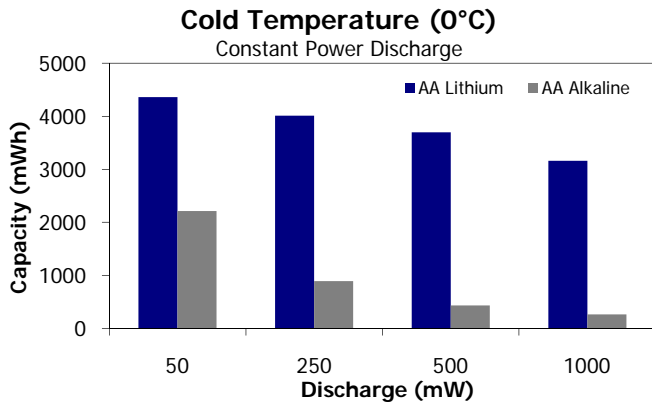

Important Notice

This datasheet contains typical information specific to products manufactured at the time of its publication.
©Energizer Holdings, Inc. - Contents herein do not constitute a warranty.

ENERGIZER L91

AA

Typical Discharge Curve Characteristics

Constant Current Discharge at 21°C (low and high drains)

Low Drain Performance
50mA Continuous (21°C)

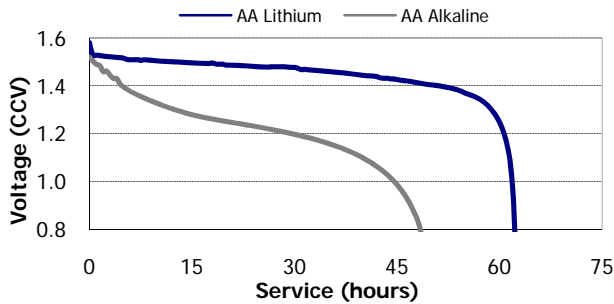

High Drain Performance
1000mA Continuous (21°C)

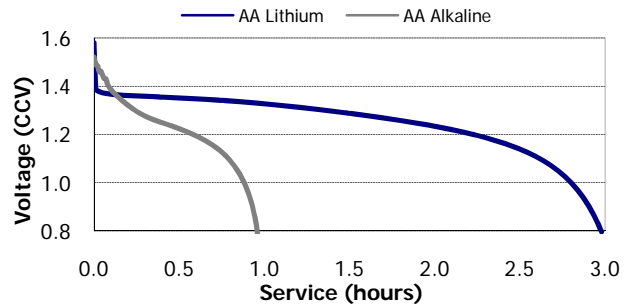

Constant Power Performance

Typical Characteristics to 1.0 Volts (21°C)

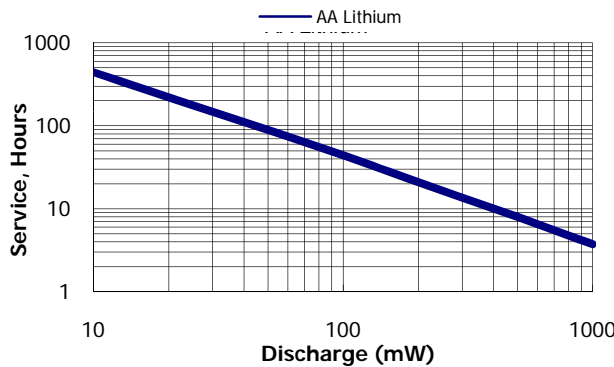

Constant Current Performance

Typical Characteristics to 1.0 Volts (21°C)

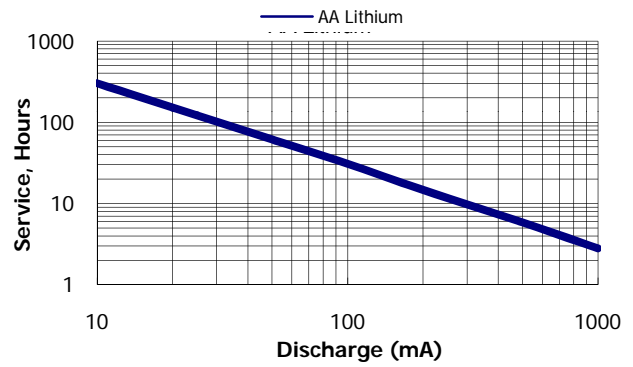

Application Tests (21°C)

REMOTE: 24 ohm 15 sec/min 8 hrs/day
RADIO: 43 ohm 4 hrs/day

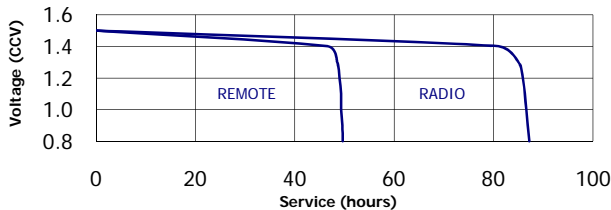

Application Tests (21°C)

CD/GAMES: 250 mA 1 hr/day
DIGITAL AUDIO: 100 mA 1 hr/day

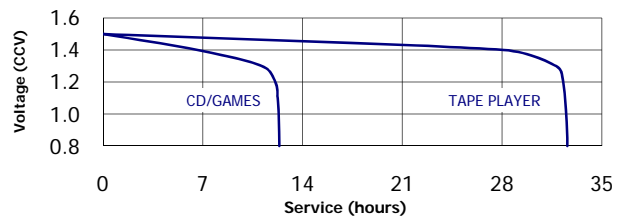

Application Tests (21°C)

TOOTHBRUSH: 500 mA 1/13 min 24 hrs/day
PORTABLE LIGHTING: 3.3 ohm LIF
TOY: 3.9 ohm 1 hr/day

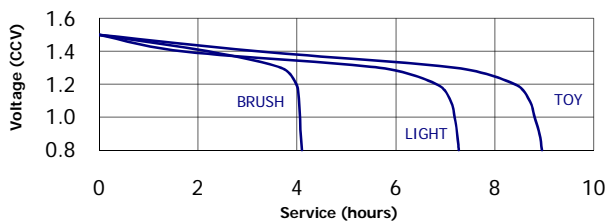

Industry Standard Tests (21°C)

PHOTOFLASH: 1K mA 10 sec/min 1 hr/day
DIGITAL CAMERA: 1.5/.65K mW 2.1/27.9s 10X

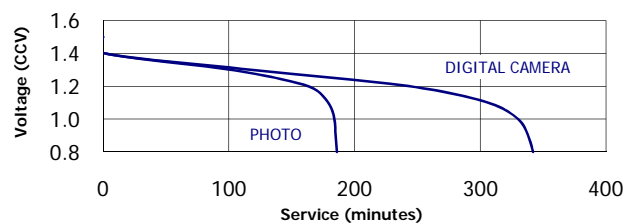

Important Notice

This datasheet contains typical information specific to products manufactured at the time of its publication.
©Energizer Holdings, Inc. - Contents herein do not constitute a warranty.