

Manganese Dioxide Lithium Coin Batteries: Individual Specifications

CR1616

■ Dimensions(mm)

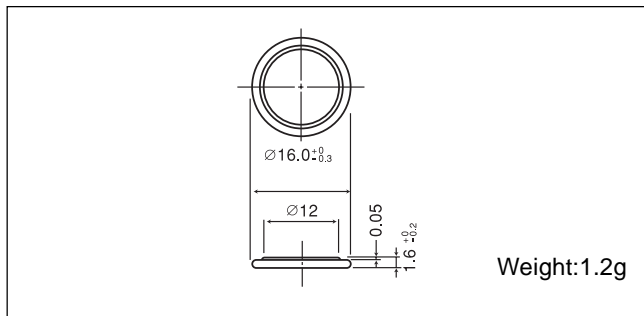

■ Specification

Nominal voltage (V)	3
Nominal capacity (mAh)	55
Continuous standard load (mA)	0.1
Operating temperature (C)	-30 ~ +60

■ Temperature Characteristics

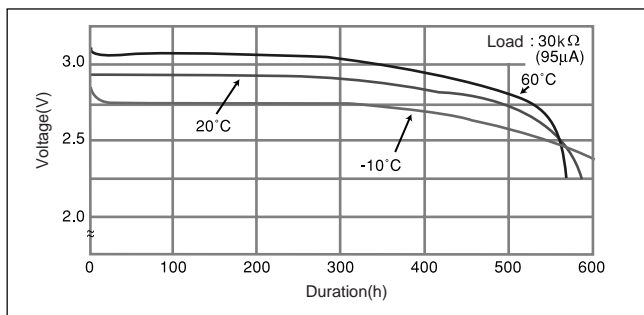

■ Operating voltage vs. load resistance (voltage at 50% discharge depth)

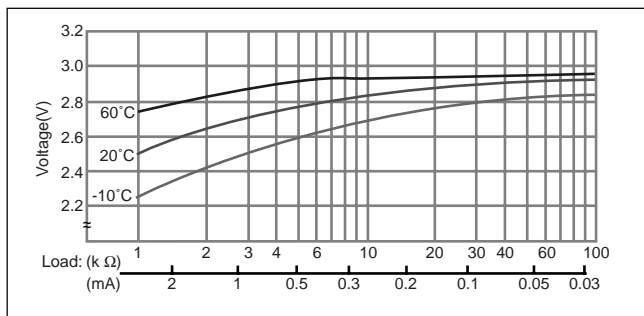

■ Capacity vs. load resistance

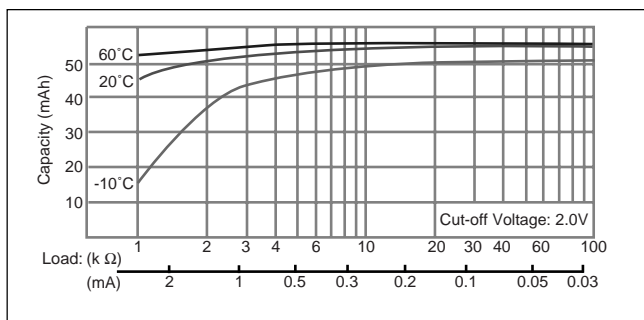

CR1620

■ Dimensions(mm)

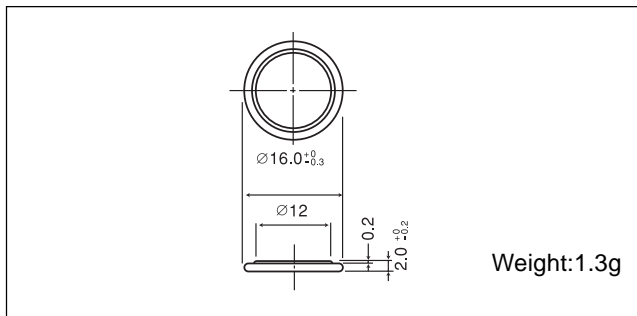

■ Specification

Nominal voltage (V)	3
Nominal capacity (mAh)	75
Continuous standard load (mA)	0.1
Operating temperature (C)	-30 ~ +60

■ Temperature Characteristics

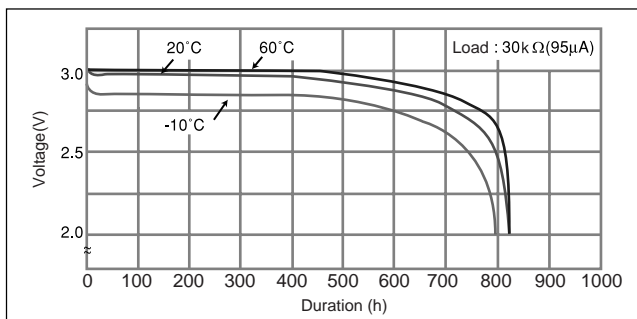

■ Operating voltage vs. load resistance (voltage at 50% discharge depth)

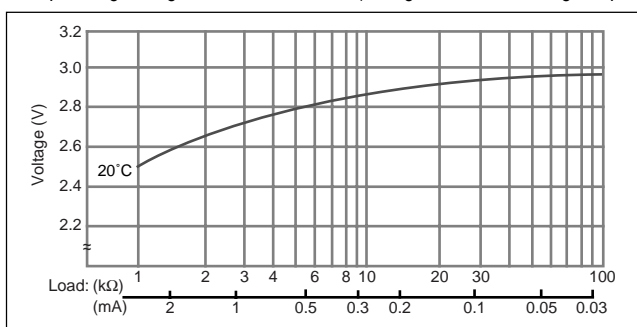

■ Capacity vs. load resistance

