

Manganese Lithium Coin Batteries (ML series): Individual Specifications

ML612S

■ Dimensions(mm)

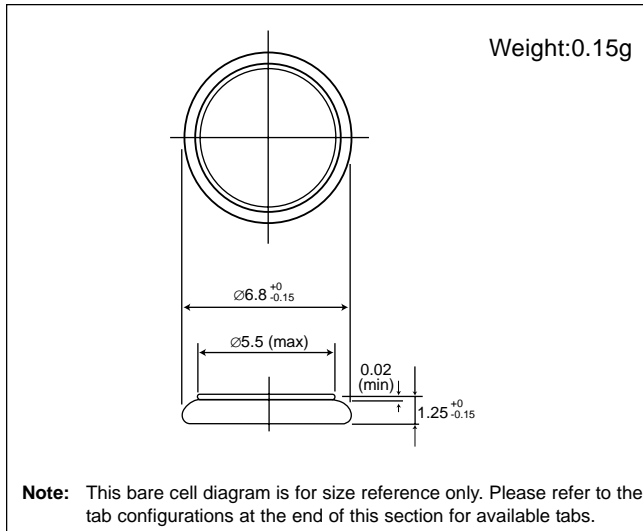

■ Specification

Nominal voltage (V)	3
Nominal capacity (mAh)	2.6
Continuous standard load (mA)	0.01
Operating temperature (C)	-20 ~ +60

■ Discharge characteristics

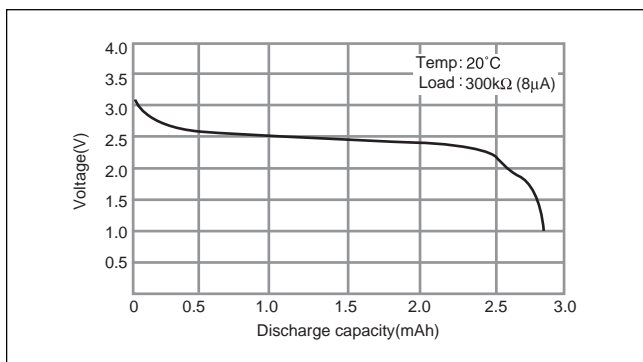

■ Consumption current vs. Duration time

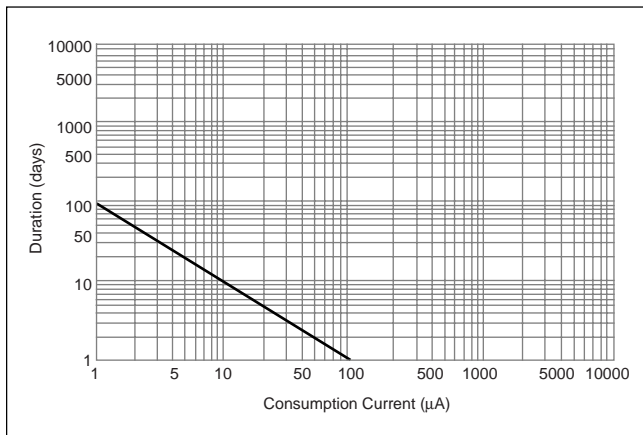

ML614S

■ Dimensions(mm)

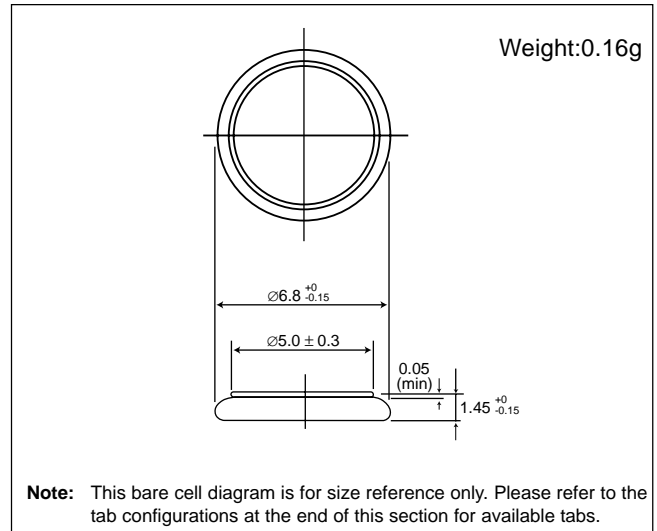

■ Specification

Nominal voltage (V)	3
Nominal capacity (mAh)	3.4
Continuous standard load (mA)	0.01
Operating temperature (C)	-20 ~ +60

■ Discharge characteristics

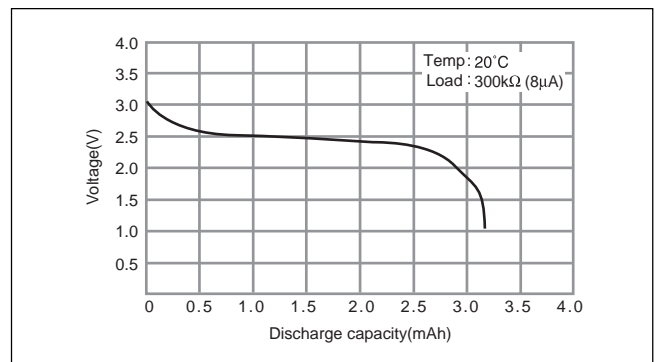

■ Consumption current vs. Duration time

