

5.0 Closure Assembly

5.1 3M™ Scotchcast™ Kits 8981-8986

Clean and scuff completely around the cables sheath for distances indicated using sheath scuff.

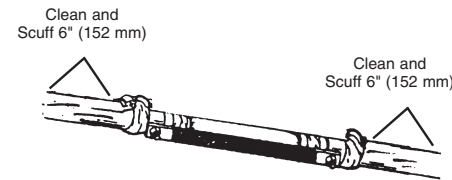

5.2 8981 Closure

Secure one end of spacer web to the cable with a cable tie. Spiral wrap spacer web tightly around splice bundle. Secure end to cable with cable tie.

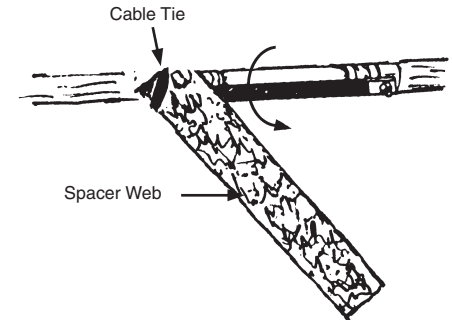

5.3 8982-8986 Closures

Install spacer web and secure in place with cable ties.

Note: Do not overlap spacer web.

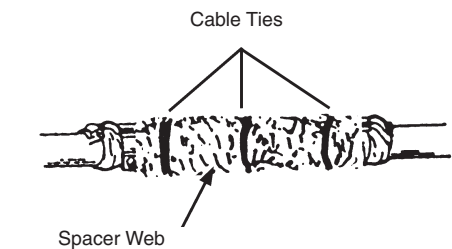
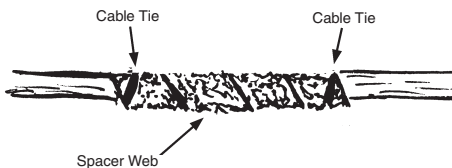

5.4 Center the closure over the splice opening. For 8981 and 8983 kits, position the bubbles over the shield connectors.

5.5 Trim closure ends so that they loosely fit on the cable outer sheath.



3M™ Scotchcast™ Kits 8981-8983



3M™ Scotchcast™ Kits 8984-8986

5.6 Install closures.

Align the tongue and groove and snap the closure halves together. **HINT:** Pliers may be used to snap the closure halves together, but be sure that the tongue and groove are properly engaged before crimping the flanges.



5.7 Wrap the closure ends with DR or 23 rubber tape provided in the kit.

5.8 Install funnels on 3M™ Scotchcast™ Kits 8981-8983.

6.0 Closure Filling

6.1 Position closure:

8981-8983 kits: Slightly incline closure 1/2" (13 mm).

8984-8986 kits: Keep closure level.

6.2 Mix compound per instructions on Uni-pack container guard bag.

Note: For health, safety and disposal information refer to compound label or Material Safety Data Sheet for encapsulating compound being used.

6.3 Pour compound:

8981-8983 kits: Pour compound into closure through funnel on low end only. Pour until compound fills closure and reaches top of funnel on lower end.

8984-8986 kits: Pour compound to top of air vents. Replace cover onto pour opening. Closure can be buried immediately.

7.0 Re-entry of Re-enterable Compound Splice

7.1 Remove rubber tape strips from closure ends.

7.2 Grip or pry out closure end and pull closure off encapsulated splice.

7.3 Remove spacer web from splice and discard. DO NOT REUSE SPACER WEB. Remove as much encapsulant as possible.

7.4 After completion of repair or modification, reassemble closure according to procedure outlined in Closure Assembly section. Closure halves may be reused.

Note: Spacer web in roll form is available in 3" (76 mm) and 6" (152 mm) x 20' (6 m) rolls (4430). Be sure that the spacer web does not block the fill ports. Do not overlap spacer web.

7.5 Fill closure with new encapsulant (high gel) as outlined in Closure Filling. The new high gel encapsulant will bond to the original encapsulant left in the splice.

7.6 Closure can be buried immediately.

Note: 3M™ Scotchcast™ Encapsulated Closures 4407 are not Re-enterable.

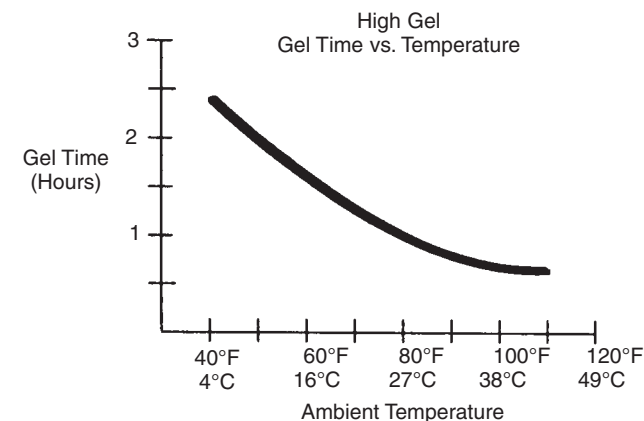

3M

Communication Markets Division
3M Telecommunications
6801 River Place Blvd.
Austin, TX 78726-9000
800.426.8688
Fax 800.626.0329
www.3MTelecommunications.com

Please recycle. Printed in USA
© 3M 2007. All rights reserved.
78-8097-8956-9-F

3M

Scotchcast™ Splice Encapsulation Kits 8980 Series

(with 3M™ High Gel Encapsulating Compound or 3M™ Scotchcast™ Encapsulating Compound 4407)

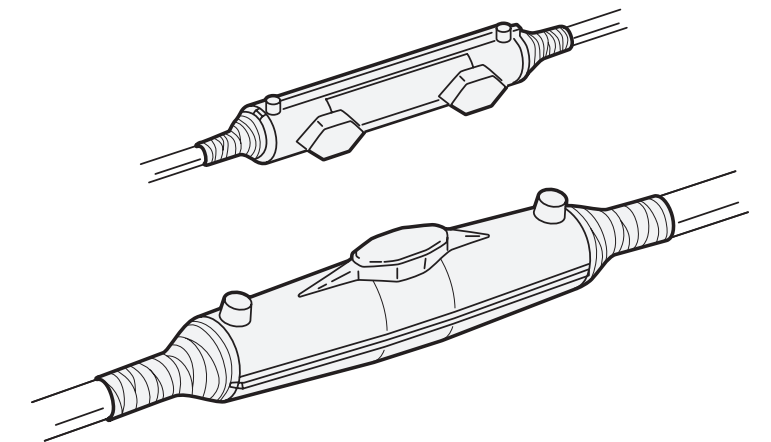

Important Notice

3M™ MS²™ splicing rigs, tools and modules are engineered to work together to achieve consistently superior performance in the field. Modules from other manufacturers may not meet the tight quality tolerances of 3M modules and may damage the calibration and performance of a 3M rig or tool. Therefore, the published 3M warranty does not extend to any 3M modules spliced in rigs or tools not made by 3M. The warranty on 3M MS²™ splicing rigs and Scotchlok™ splicing tools can also be violated if used on non-3M modules.

All statements, technical information, and recommendations related to 3M's products are based on information believed to be reliable, but the accuracy or completeness is not guaranteed. Before using this product, you must evaluate it and determine if it is suitable for your intended application. You assume all risks and liability associated with such use. Any statements related to the product which are not contained in 3M's current publications, or any contrary statements contained on your purchase order shall have no force or effect unless expressly agreed upon, in writing, by an authorized officer of 3M.

Warranty; Limited Remedy; Limited Liability.

This product will be free from defects in material and manufacture for a period of one (1) year from the time of purchase. **3M MAKES NO OTHER WARRANTIES INCLUDING, BUT NOT LIMITED TO, ANY IMPLIED WARRANTY OF MERCHANTABILITY OR FITNESS FOR A PARTICULAR PURPOSE.** If this product is defective within the warranty period stated above, your exclusive remedy shall be, at 3M's option, to replace or repair the 3M product or refund the purchase price of the 3M product. **Except where prohibited by law, 3M will not be liable for any indirect, special, incidental or consequential loss or damage arising from this 3M product, regardless of the legal theory asserted.**

January 2007
78-8097-8956-9-F



1.0 General

- 1.1 The 3M™ Scotchcast™ Splice Kit 8980 Series has six rigid body closure sizes available. The closure kit includes spacer webbing to keep the splice bundle away from the closure wall and allow the encapsulating compound to flow around the splice.
- 1.2 3M™ High Gel Encapsulant is a two-part, re-enterable non-polyurethane encapsulating compound.
- 1.3 3M™ Scotchcast™ Compound 4407 is a two-part, non-re-enterable polyurethane encapsulating compound.
- 1.4 This practice describes the application of 8980 series kits with high gel or 4407 encapsulating compound (using the steps applicable to 4407 kits). See Kit Selection Guide for individual kit capabilities.

2.0 Kit Contents

* in 4407 kits; √ in High Gel kits; X not applicable

Kit Contents	8981	8982/8983	8984	8985/8986
“closure halves, one each”	* √	* √	* √	* √
pour spouts (2)	* √	* √	X	X
strain relief bar	X	X	√	√ (2)
bonding strap	X	√	X	X
service wire connector	√ (4464)	X	X	X
spacer tube	X	√	√	√
spacer web	* √	* √	* √	* √
DR tape	X	√	√	√
88T vinyl tape	X	√	√	√
B sealant tape strips	X	√	√	√
shield bond connectors	√(4460-D)(2)	√(4460-D)(2)	√(4460-D)(2)	√(4462-FN)(4)
compound	* √	* √	* √	* √
sheath scuff	X	√	√	√
cable ties (2)	√	√	√	√
cover	X	X	* √	* √
#23 tape strips (3)	* √	*	*	*
fiberglass strip (2)	X	X	*	*

- 2.2 Accessories Required:
Splicing connectors
Additional rubber tape, if needed
"B" sealing tape, if needed

Visually inspect all components. If any component is missing or appears damaged, do not install. Call 3M customer service at 1-800-426-8688 for a replacement product.

3.0 Cable Preparations

- 3.1 Prepare the cables. Cut shield flush with the outer sheath and scuff the inner sheath (on double sheath cables).

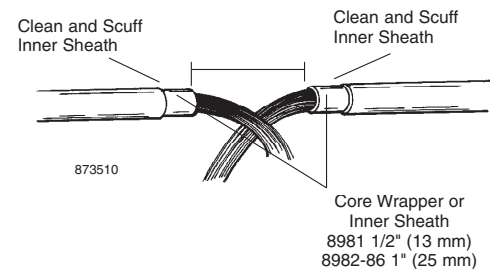

3M™ Scotchcast™ Kit Number	Splice Opening
8891	1.5" (38 mm)
8982	5.25" (133 mm)
8983	9.75" (248 mm)
8984	9" (228 mm)
8985	17" (431 mm)
8986	17" (431 mm)

3.2 Filled Cables

For best results, clean filled cables thoroughly before encapsulating.

Note: Carefully follow health, safety and environmental information given on cable cleaner label or Material Safety Data Sheet.

- 3.3 For 8982-8986 kits, insert the shield connector between the shield and the inner sheath (or core wrapper on single sheath cables). On 8982-8983 kits, make certain the shield connector studs are aligned with “bubbles” on the side of the mold body. (Note: Cables show 4462-FN shield connector).

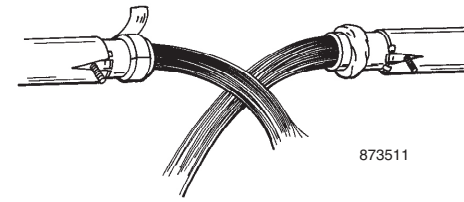

- 3.4 For cables less than 3/4" (19 mm) in diameter, cut a 1" (25 mm) slit in the sheath opposite the connector location. Then complete the procedure.

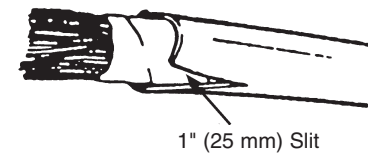

- 3.5 Install shield bond connector and bond bar. Then install one nut securely onto shield bond connector stud.

Note: Torque 4460 series shield connector nuts to 30-35 in-lbs (3.4-4.0 kg•m)

Torque 4462 series shield connector nuts to 45 ± 5 in-lbs (5.2 ± 0.6 kg•m).

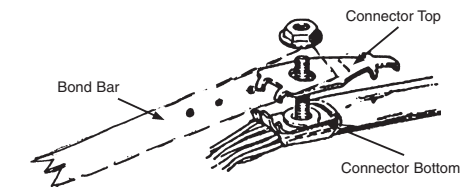

- 3.6 Cut off excess stud.

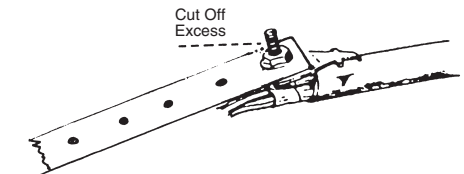

- 3.7 For double sheath cables, build sealing collars on the inner sheath. Each sealing collar consists of one wrap of 3/4" (19 mm) wide B sealing tape cut in half 3/8" (9 mm) and completely overwrapped with at least two turns of 3/4" (19 mm) highly stretched DR tape, white side out.

- 3.8 For 3M™ Scotchcast™ Kits 8981-8986, continue shield by installing the bonding strap or strain bar(s) across the splice opening.

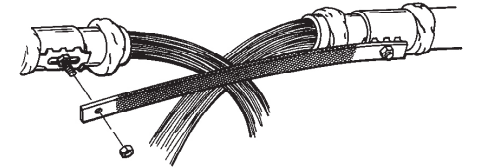

- 3.9 Build outer sheath sealing collars just beyond the nose of the shield bond connector—each sealing collar consists of one 3/4" (19 mm) wrap of B sealing tape cut in half 3/8" (9 mm) and completely overwrapped with at least two turns of highly stretched DR tape, white side out. (Collars must be covered by closure).

- 3.10 For multiple cables:

- (a) Center a closure-half over the splice and mark the closure end location on the cables.

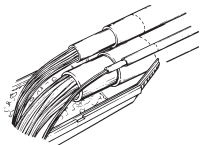

- (b) Seal cables together with B sealing tape filling all voids between the cables. Trim closure ends to fit build up.

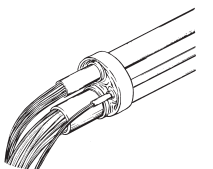

4.0 Splice Conductors per company practice

Kit Selection Guide

Kit	Max. Pair Count †	Max. Cable O.D.	Max. Splice O.D.	With High Gel Re-enterable Compound	Approx. Inside Closure Dia.
8981/High Gel*	4/24	0.625" (16 mm)	1.5" (38 mm)	(1) "A" Size Uni-pack 82 g (90 ml)	0.5" (13 mm)
8982/ High Gel**	18/24***	1" (25 mm)	5.25" (133 mm)	(1) "E" Size Uni-pack 266 g (292 ml)	0.9" (22mm)
8983/High Gel	50/24	1.5" (38 mm)	9.75" (248 mm)	(1) "D" Size Uni-pack 600 g (659 ml)	1.25" (32 mm)
8984/High Gel	100/22	2" (51 mm)	9" (228 mm)	(2) "D" Size Uni-pack 1200 g (1318 ml)	2.25" (58 mm)
8985/High Gel	400/22	2.375" (60 mm)	17" (431 mm)	(5) "D" Size Uni-pack 2400 g (3295 ml)	3.5" (90 mm)
8986/High Gel	600/22	3.33" (86 mm)	17" (431 mm)	(10) "D" Size Uni-pack 6000 g (6590 ml)****	4.75" (120 mm)

*Intended for use on single cables only
**Not intended for use with MS²™ Modules.

***On double sheath cable 14/24 is recommended maximum
****Additional compound may be required depending on cable size.

Kit	Max. Pair Count †	Max. Cable O.D.	Max. Splice O.D.	With Scotchcast 4407 Encapsulating Compound	Approx. Inside Closure Dia.
8981-07*	4/24	0.625" (16 mm)	1.5" (38 mm)	(1) "A" Size Uni-pack 94 g (90 ml)	0.5" (13 mm)
8982-07*	18/24	1" (25 mm)	5.25" (133 mm)	(1) "E" Size Uni-pack 300 g (290 ml)	0.9" (22mm)
8983-07	50/24	1.5" (38 mm)	9.75" (248 mm)	(1) "D" Size Uni-pack 675 g (660 ml)	1.25" (32 mm)
8984-07	100/22	2" (51 mm)	9" (228 mm)	(2) "D" Size Uni-pack 1350 g (1320 ml)	2.25" (58 mm)
8985-07	400/22	2.375" (60 mm)	17" (431 mm)	(5) "D" Size Uni-pack 3375 g (2640 ml)	3.5" (90 mm)
8986-07	600/22	3.33" (86 mm)	17" (431 mm)	(10) "D" Size Uni-pack 6750 g (6600 ml)**	4.75" (120 mm)

*The 8981-07 and the 8982-07 kits are intended for use on single sheath cables only.
**Additional compound may be required depending on cable size.

† Maximum pair count with 3M™ Scotchlok™ Connectors UY or 3M™ MS²™ Modules.
‡ Inside closure diameter measured at center, minus spacer webbing.