

Recommended Panel Cut-Out

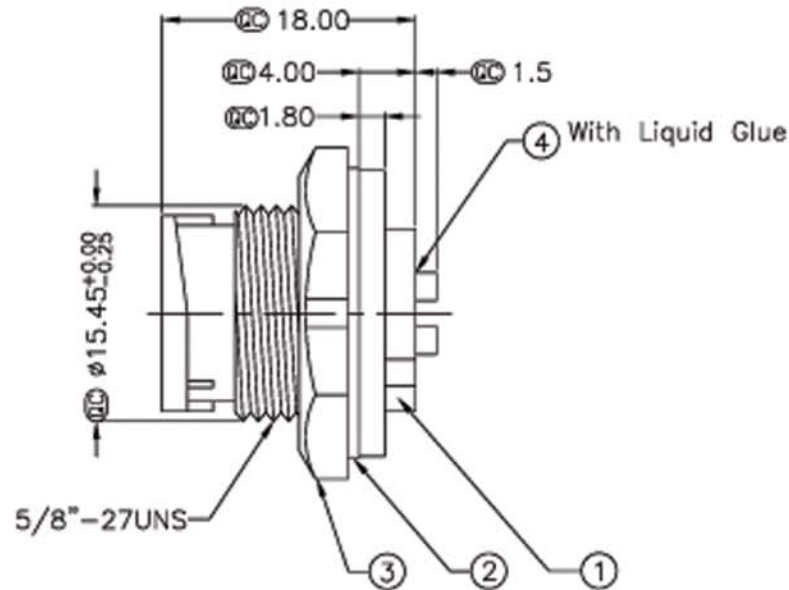
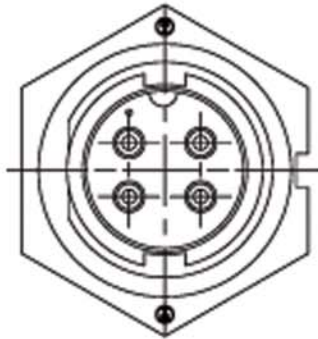
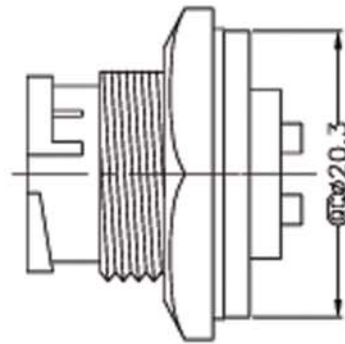

Pin Assignments
Front View

Notes:

- Waterproof Rate: IP67
- Connector: Black, Nylon+GF
- Pin: Copper Alloy, Gold Plated



ITEM NO
A-CR-04PMMS-LC-WP-R (Male, 4 Pin)

TITLE
Waterproof Circular Connector (5A), PCB, Panel Mount

ASSMANN
Electronics, Inc.

1840 W. Drake Drive, Suite 101 - Tempe, AZ 85283
Toll Free: 1-877-277-6266 Email: info@usa-assmann.com

THIS DRAWING IS UNPUBLISHED
© Copyright 2008 by Assmann Electronic Components
All International Rights Reserved