

REV.	DESCRIPTION	DATE
A	NEW DRAWING	4/6/2006
B	Model update	10/6/2006
C	dimension change from 34.0 to 36.0mm	8/4/2008

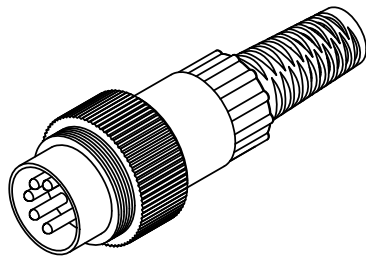

SCALE 1:1

TOLERANCE:
 X.X ± 0.2 mm
 X.XX ± 0.1 mm
 X.XXX ± 0.05 mm

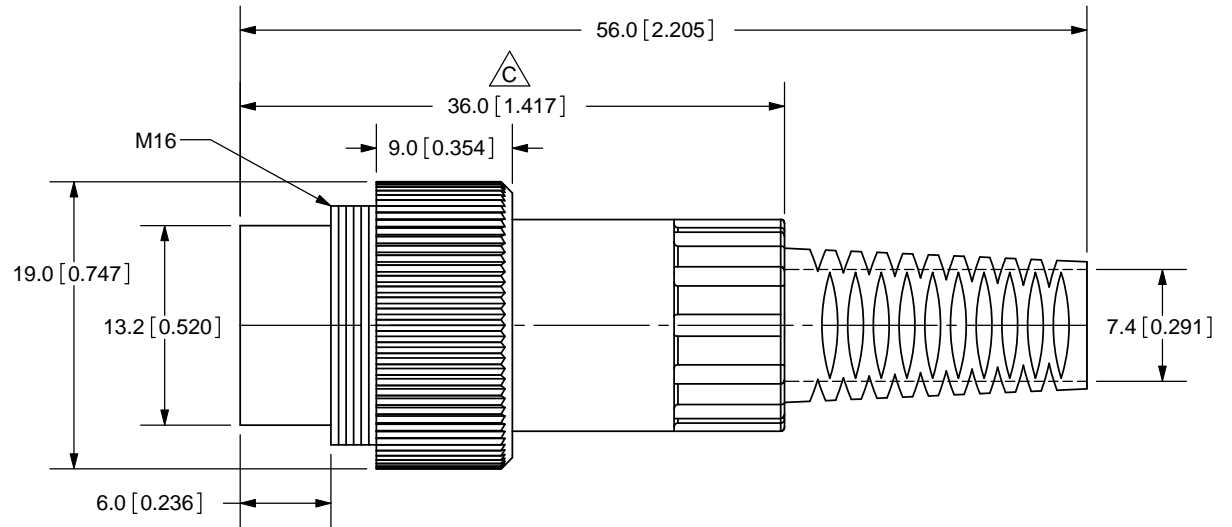
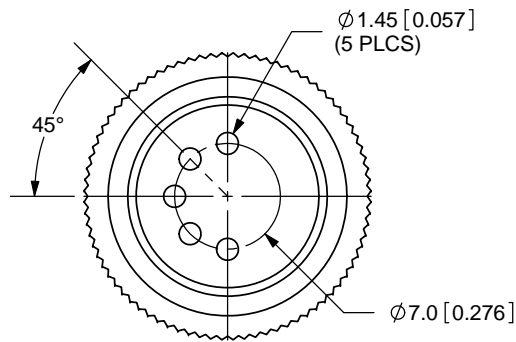

20050 SW 112th Ave.
 Tualatin, OR 97062
 Phone: 503-612-2300
 800-275-4899
 Fax: 503-612-2383
 Website: www.cui.com

SPECIFICATIONS:
 RATING: 100V AC @ 2A
 CONTACT RESISTANCE: 20m OHMS MAX
 INSULATION RESISTANCE: 100M OHMS MIN: 500V DC
 VOLTAGE WITHSTAND: 1000V AC R.M.S. FOR 1 MINUTE

TITLE: DIN PLUG, LOCKING, IN-LINE 5P		REV: C
PART NO. SD-50LP		UNITS: MM [INCHES]
DRAWN BY: ZRJ	APPROVED BY:	SCALE: 2:1

PC FILE NAME:
 SD-50LP

COPYRIGHT 2008 BY CUI INC.