

REV.	DESCRIPTION	DATE
A	NEW DRAWING	4/6/2006
B	Model update	10/6/2006
C	dimension change from 34.0 to 36.0mm	8/4/2008

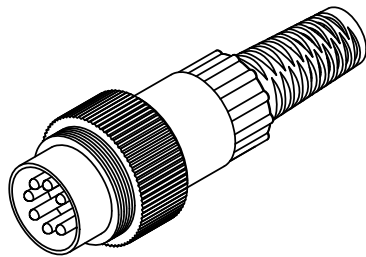

SCALE 1:1

TOLERANCE:
X.X ±0.2mm
X.XX ±0.1mm
X.XXX ±0.05mm

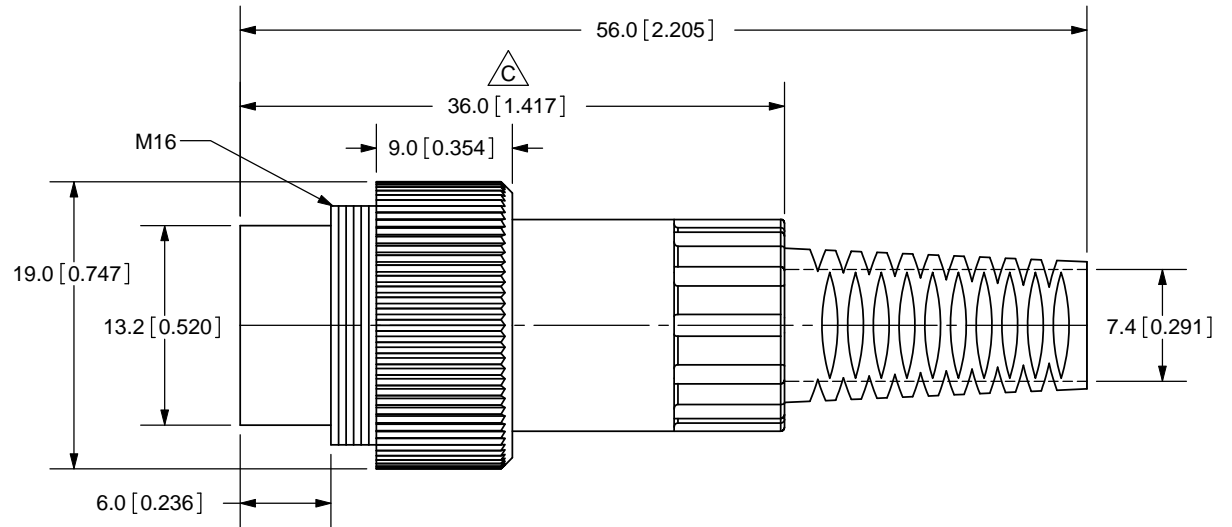
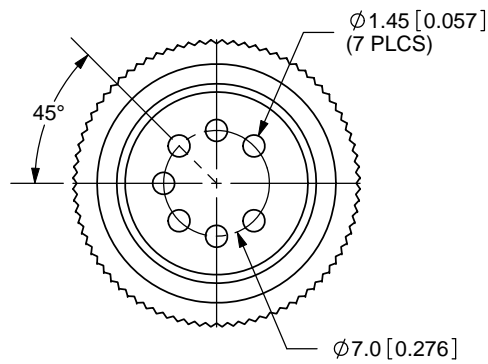

20050 SW 112th Ave.
Tualatin, OR 97062
Phone: 503-612-2300
800-275-4899
Fax: 503-612-2383
Website: www.cui.com

SPECIFICATIONS:
RATING: 100V AC @ 2A
CONTACT RESISTANCE: 20m OHMS MAX
INSULATION RESISTANCE: 100M OHMS MIN: 500V DC
VOLTAGE WITHSTAND: 1000V AC R.M.S. FOR 1 MINUTE

TITLE: DIN PLUG, LOCKING, IN-LINE 7P		REV: C
PART NO. SD-70LP		UNITS: MM [INCHES]
DRAWN BY: ZRJ	APPROVED BY:	SCALE: 2:1

PC FILE NAME: SD-70LP

COPYRIGHT 2008 BY CUI INC.