

REV.	DESCRIPTION	DATE
A	NEW DRAWING	4/6/2006

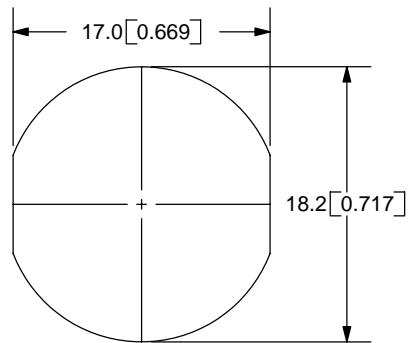

Panel Cutout

TOLERANCE:
 X.X ±0.2mm
 X.XX ±0.1mm
 X.XXX ±0.05mm

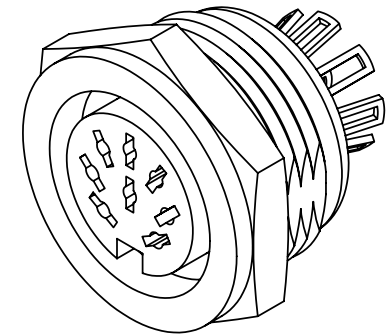
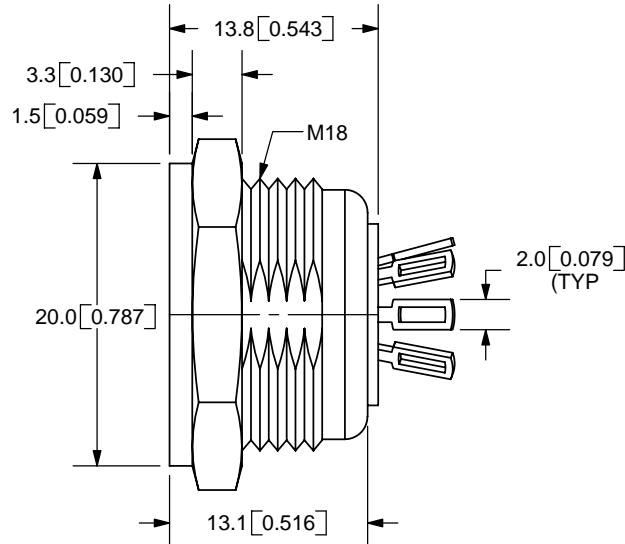
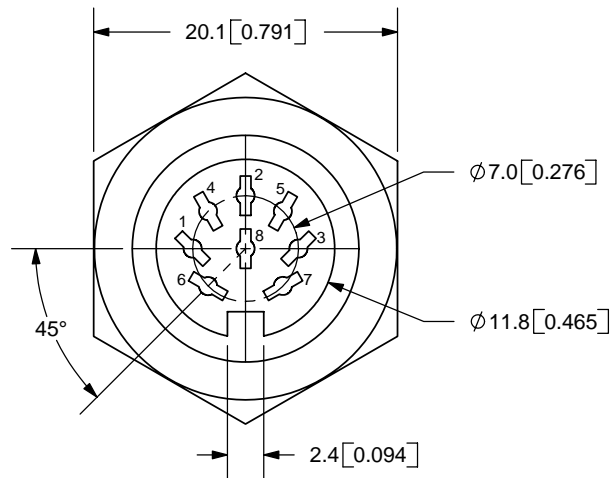

SPECIFICATIONS:
 RATING: 100V AC @ 2A
 CONTACT RESISTANCE: 20m OHMS MAX
 INSULATION RESISTANCE: 100M OHMS MIN: 500V DC
 VOLTAGE WITHSTAND: 1000V AC R.M.S. FOR 1 MINUTE
 LIFE: 5,000 CYCLES



9615 SW Allen Blvd., Ste. 103
 Beaverton, OR 97005
 Phone: 503-643-4899
 800-275-4899
 Fax: 503-372-1266
 Website: www.cui.com

	MATERIAL	PLATING	TITLE: DIN RECEPTACLE, PANEL MOUNT	REV: A
CONTACT TERMINALS	Brass	Silver	PART NO. SD-80LS	UNITS: MM [INCHES]
HEX NUT	Brass	Nickel		
COVER	Brass	Nickel	DRAWN BY: ZRJ	APPROVED BY:
HOUSING	Nylon			

PC FILE NAME:
SD-80LS

COPYRIGHT 2006 BY CUI INC.