

REV.	DESCRIPTION	DATE
A	NEW DRAWING	9/1/2006

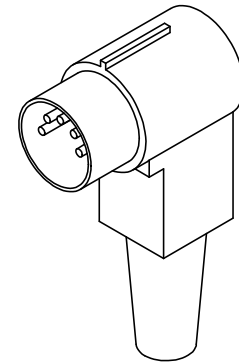

TOLERANCE:
X.X ±0.2mm
X.XX ±0.1mm
X.XXX ±0.05mm

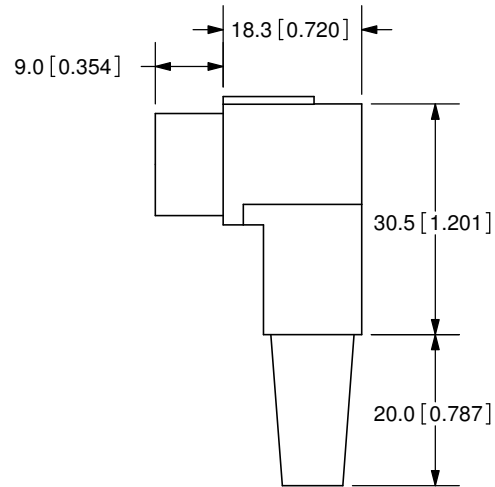
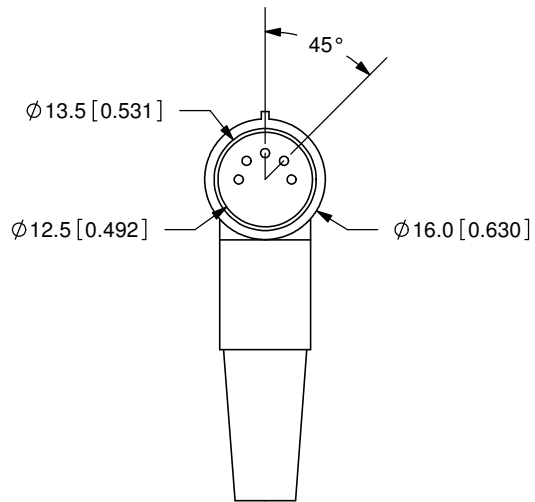

SPECIFICATIONS:
RATING: 100V AC @ 1A
CONTACT RESISTANCE: 30m OHMS MAX
INSULATION RESISTANCE: 100M OHMS MIN; 500V DC
VOLTAGE WITHSTAND: 250V AC R.M.S. FOR 1 MINUTE
LIFE: 5,000 CYCLES



CUI INC

20050 SW 112th Ave.
Tualatin, OR 97062
Phone: 503-612-2300
800-275-4899
Fax: 503-612-2383
Website: www.cui.com

	MATERIAL	PLATING
PINS	Brass	Nickel
CONTACT 1	Steel	Nickel
CONTACT 2	Steel	Nickel
CAP	Polyethylene	
INSULATOR	ABS	

TITLE: DIN PLUG		REV: A
PART NO. SDR-50		UNITS: MM [INCHES]
DRAWN BY: ZRJ	APPROVED BY:	SCALE: 1:1

PC FILE NAME:
SDR-50

COPYRIGHT 2007 BY CUI INC.