

REV.	DESCRIPTION	DATE
A	NEW DRAWING	12/21/2005

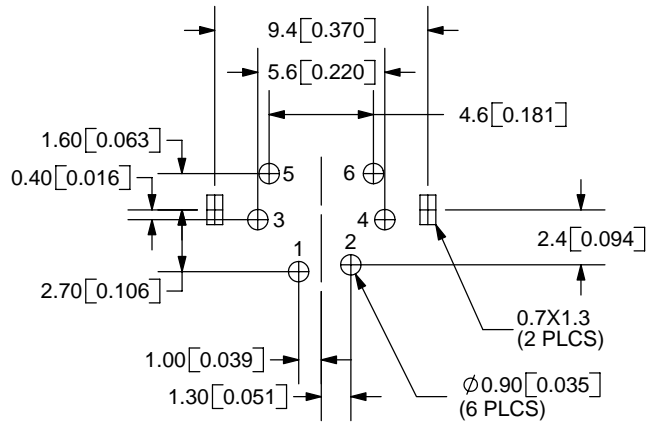
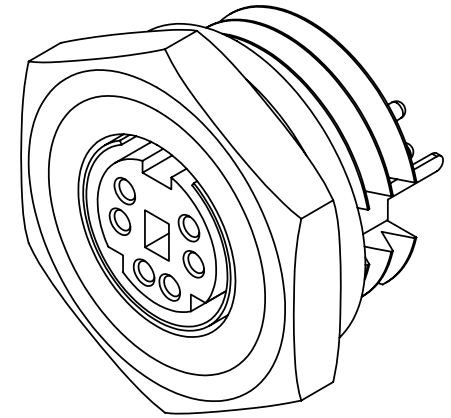
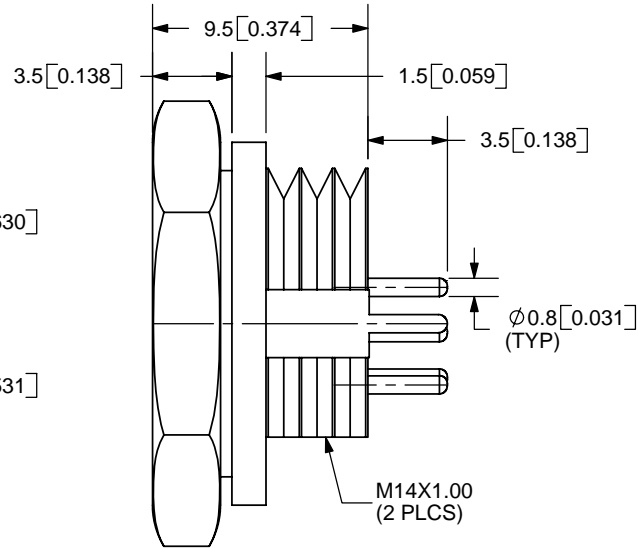
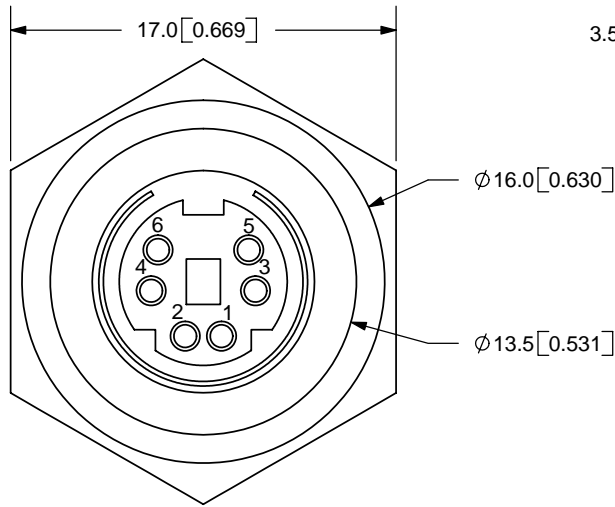

PCB LAYOUT  
BACK VIEW

**SPECIFICATIONS:**  
RATING: 12V DC @ 2A; 100V AC @ 1A  
INSULATION RESISTANCE: 50M OHMS MIN; 250V DC  
VOLTAGE WITHSTAND: 250V AC R.M.S. FOR 1 MINUTE  
CONTACT RESISTANCE: 30m OHMS MAX  
INSERTION FORCE: 4.5KG MAX  
WITHDRAWAL FORCE: 0.8KG~3KG  
LIFE: 5,000 CYCLES

	MATERIAL	PLATING
TERMINALS (1-6)	Phosphor Bronze	Silver
EARTH TERMINAL	Brass	Tin
HOUSING	PBT	

TOLERANCE:  
±0.2mm



20050 SW 112th Ave.  
Tualatin, OR 97062  
Phone: 503-643-4899  
800-275-4899  
Fax: 503-372-1266  
Website: www.cui.com

TITLE:	MINI CIRCULAR CON.-VERTICAL MOUNT	REV:	A
PART NO.	MD-60CV	UNITS:	MM [INCHES]
DRAWN BY:	ZRJ	APPROVED BY:	
		SCALE:	3:1

PC FILE NAME:  
MD-60CV

COPYRIGHT 2006 BY CUI INC.