

REV.	DESCRIPTION	DATE
A	NEW DRAWING	10/25/2005
B	added missing dimensions	1/29/2008

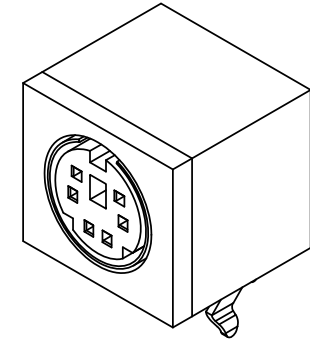

TOLERANCE:
±0.2mm UNLESS OTHERWISE
SPECIFIED

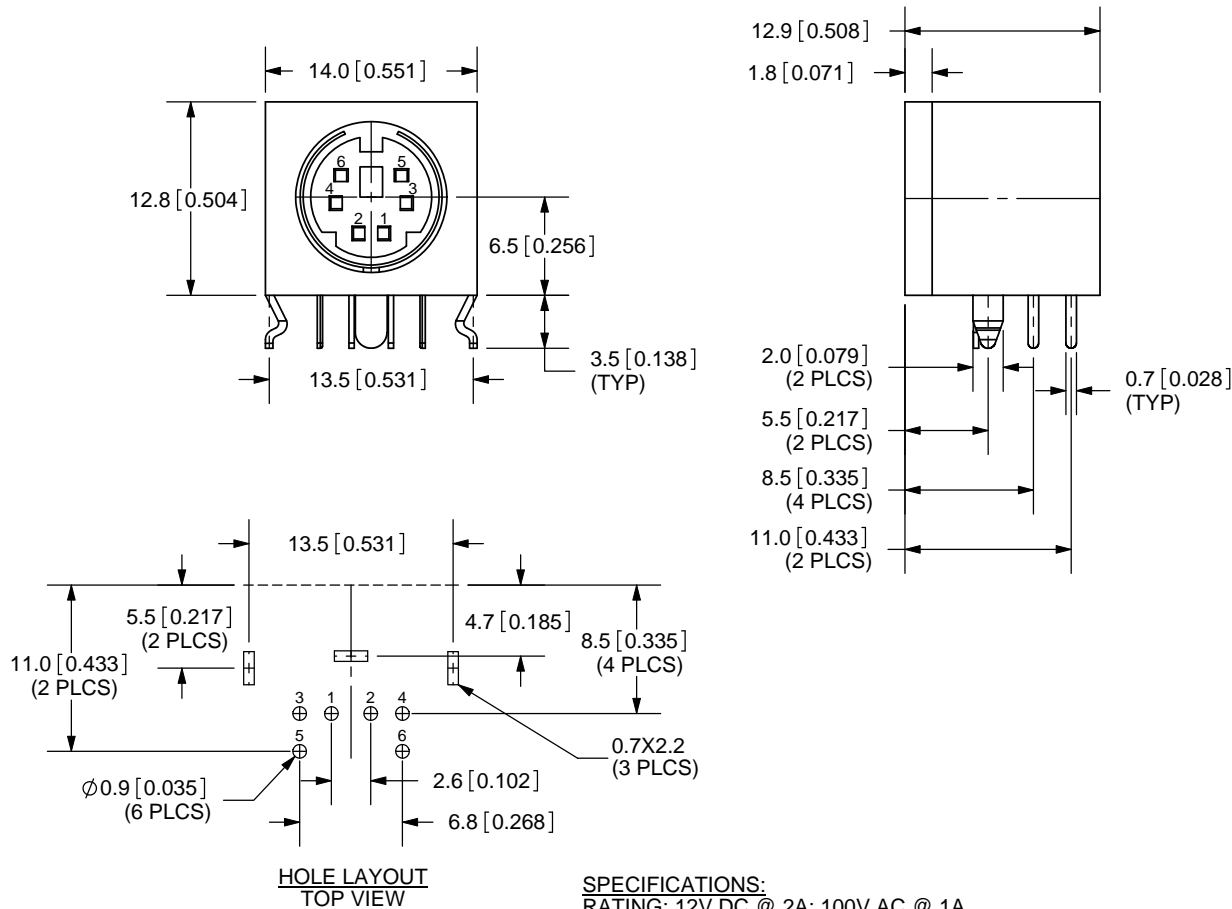

20050 SW 112th Ave.
Tualatin, OR 97062
Phone: 503-612-2300
800-275-4899
Fax: 503-612-2383
Website: www.cui.com

SPECIFICATIONS:
 RATING: 12V DC @ 2A; 100V AC @ 1A
 INSULATION RESISTANCE: 10M OHMS MIN; 250V DC
 VOLTAGE WITHSTAND: 250V AC R.M.S. FOR 1 MINUTE
 CONTACT RESISTANCE: 30m OHMS MAX
 INSERTION FORCE: 5KG MAX
 WITHDRAWAL FORCE: 0.8KG~3.5KG
 LIFE: 5,000 CYCLES

	MATERIAL	PLATING	TITLE: MINIATURE CIRCULAR DIN CONNECTOR	REV: B
SHIELDING PLATE	Steel	Tin	PART NO. MD-60SMK	UNITS: MM [INCHES]
CONTACT TERMINALS (1-6)	Phosphor Bronze	Silver		
EARTH TERMINALS	Brass	Tin	DRAWN BY: ZRJ	APPROVED BY:
HOUSING	PBT			

PC FILE NAME:
MD-60SMK

COPYRIGHT 2008 BY CUI INC.