

REV.	DESCRIPTION	DATE
A	NEW DRAWING	1/31/2006
B	Added missing dimensions	11/7/2006

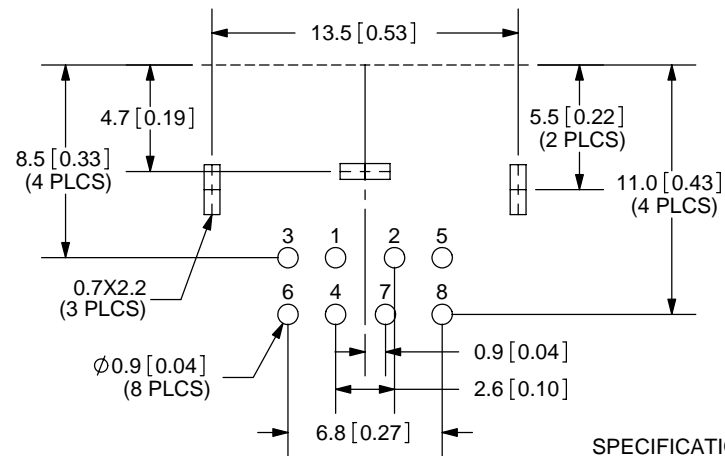
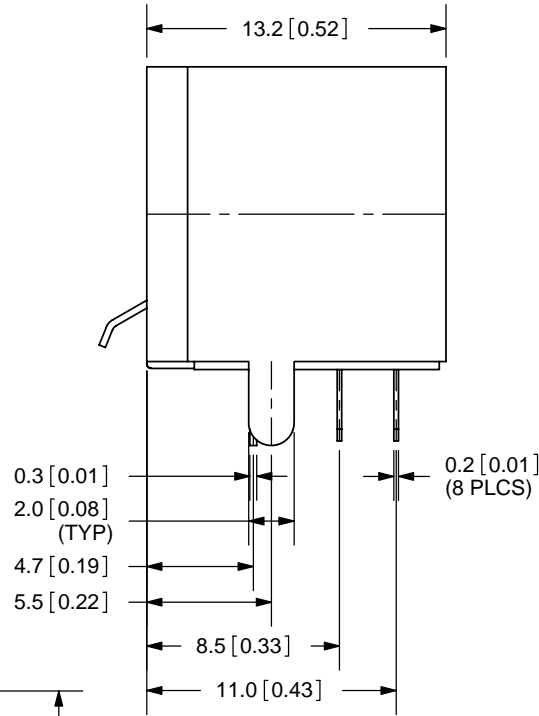
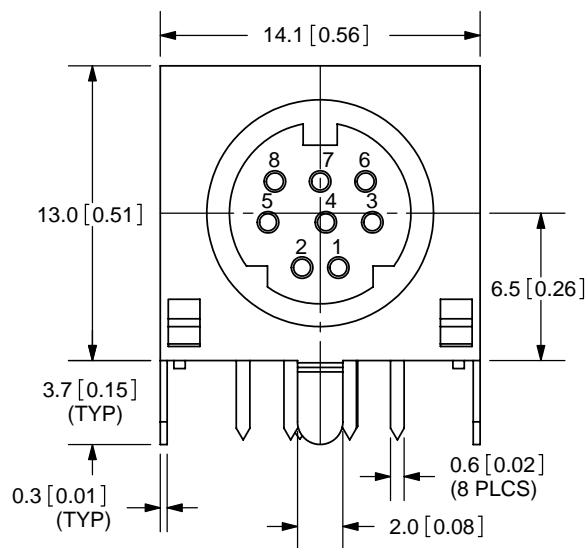

PCB LAYOUT
TOP VIEW

SPECIFICATIONS:

RATING: 12V DC @ 2A; 100V AC @ 1A
 INSULATION RESISTANCE: 50M OHMS MIN; 250V DC
 VOLTAGE WITHSTAND: 250V AC R.M.S. FOR 1 MINUTE
 CONTACT RESISTANCE: 30m OHMS MAX
 INSERTION FORCE: 1.0KG~4.5KG MAX
 WITHDRAWAL FORCE: 0.8KG~3.0KG
 LIFE: 5,000 CYCLES

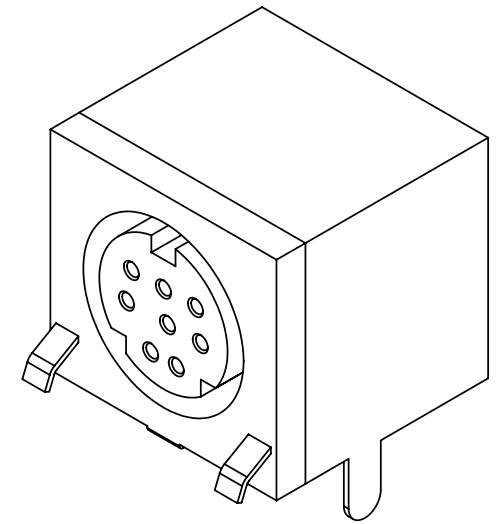

TOLERANCE:
±0.2mm



20050 SW 112th Ave.
 Tualatin, OR 97062
 Phone: 503-643-4899
 800-275-4899
 Fax: 503-372-1266
 Website: www.cui.com

PC FILE NAME:
MD-80SG

COPYRIGHT 2006 BY CUI INC.

	MATERIAL	PLATING
CONTACT TERMINALS (1-8)	Phosphor Bronze	Silver
EARTH TERMINALS	Brass	Tin
HOUSING	PBT	

TITLE: MINIATURE CIRCULAR DIN CONNECTOR	REV: B
PART NO. MD-80SG	UNITS: MM [INCHES]
DRAWN BY: ZRJ	APPROVED BY:
	SCALE: 3:1