

REVISIONS			
REV	ECN, ERN NO.	DATE	APPRD.
A	PRODUCT DRAWING (EAR 12992)	DEC12/06	K.L.

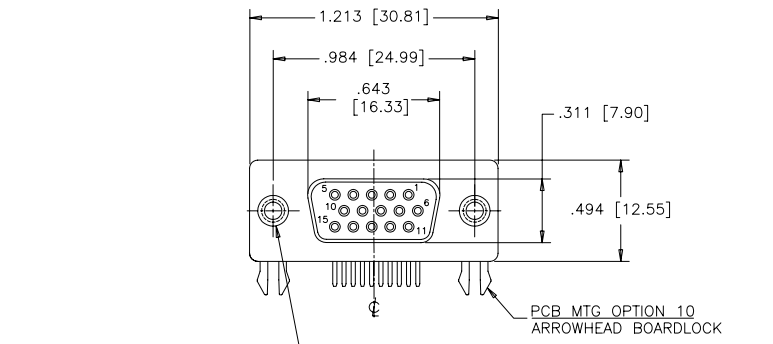

PANEL MTG OPTIONS 0 OR 1
 .120 [3.05] DIA. OR #4-40
 THROUGH HOLES (2 PLACES),
 SEE ORDERING CODE.

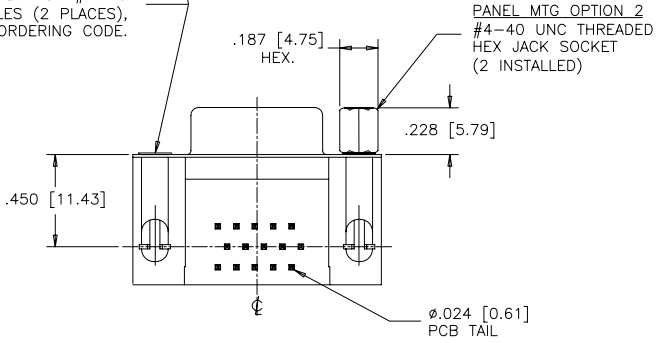

PANEL MTG OPTION 2
 #4-40 UNC THREADED
 HEX JACK SOCKET
 (2 INSTALLED)

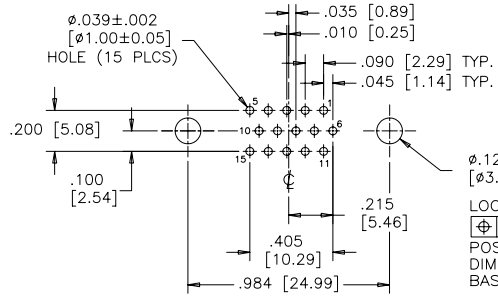

RECOMMENDED P.C.B LAYOUT
 (COMPONENT SIDE OF BOARD)

LOCATE HOLES
 ø.024 [0.61]
 POSITION
 DIMENSIONS ARE
 BASIC

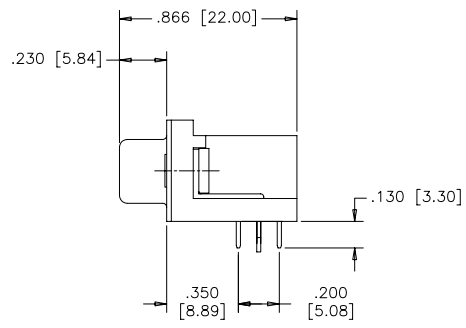

PCB MTG OPTION 00
 CLEAR HOLE

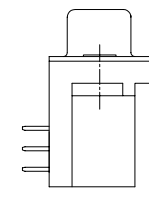
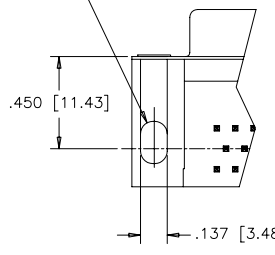

ORDERING CODE:

PART NUMBER: 1 7 E B H - 0 1 5 S A M - 2 1 0

SERIES _____
 NUMBER OF CONTACTS _____
 STYLE _____
 S = SOCKET

PCB MOUNTING OPTIONS
 00 = CLEAR HOLE
 10 = ARROWHEAD BOARDLOCK

PANEL MOUNTING OPTIONS
 0 = .120 [3.05] CLEAR HOLE
 1 = #4-40 THREADED HOLE
 2 = #4-40 UNC THREADED
 HEX JACK SOCKETS

CONTACT PLATING OPTIONS
 FOR ENGAGEMENT AREA
 AA = 3µ" [0.08 MICRONS] GOLD FLASH
 CH = 15µ" [0.38 MICRONS] GOLD
 AM = 30µ" [0.76 MICRONS] GOLD

SPECIFICATIONS:

MATERIALS: ALL MATERIALS ARE RoHS COMPLIANT.
 SHELLS: STEEL, TIN PLATED.
 INSERTS: HIGH TEMPERATURE RESISTANT NYLON, GLASS REINFORCED, UL
 FLAMMABILITY RATING 94V-0, COLOUR: BLACK.
 CONTACTS: COPPER ALLOY, GOLD PLATING (SEE ORDERING CODE) OVER
 50µ" [1.27 MICRONS] NICKEL ON ENGAGEMENT AREA WITH 100µ"
 [2.54 MICRONS] MIN. MATTE TIN ON CONTACT TERMINALS.
 BOARDLOCK: COPPER ALLOY, TIN PLATED.

ELECTRICAL DATA:

CURRENT RATING: 3 AMP
 CONTACT RESISTANCE: 15 MILLIOHMS MAX.
 INSULATION RESISTANCE: 5000 MEGOHMS MIN.
 DIELECTRIC WITHSTANDING VOLTAGE: 1000 VAC rms
 OPERATING TEMPERATURE: -55°C TO +105°C

DRAWN	J.LEE	DATE	DEC12/06
DESIGNED			
CHECKED	K.LAMBIE	DATE	DEC12/06
I. E. APPRD.			
Q. A. APPRD.			
DWG. APPRD.			
ENG. REL. NO.			
REF.	EAR 12992		
DIMENSIONS ARE IN	INCHES [mm]	CODE ID. NO.	03554

Amphenol Canada Corp.

TITLE 17EBH SERIES HIGH DENSITY D-SUB
 CONNECTOR, 15 SIZE SOCKET, RIGHT ANGLE
 PCB CONTACTS, PLATING & MOUNTING
 OPTIONS, RoHS COMPLIANT

DWG	DRAWING NO.	REV.
C	P-17EBH-015SXX-XX0	A
SCALE	2/1	WT. -----
		SURF. -----
		SHEET 1 OF 1

THIS DOCUMENT CONTAINS PROPRIETARY INFORMATION AND SUCH INFORMATION
 MAY NOT BE DISCLOSED TO OTHERS FOR ANY PURPOSE OR USED FOR MANUFACTURING
 PURPOSES WITHOUT WRITTEN PERMISSION FROM AMPHENOL CANADA CORP.