

DESCRIPTION: COAXIAL / SIGNAL - VERTICAL BOARD - FEMALE

SPECIFICATIONS:

ELECTRICAL:
 INSULATOR RESISTANCE: 5,000 MegOHMS Min.
 DIELECTRIC WITHSTANDING: 1,000VAC r.m.s.
 OPERATING TEMPERATURE: -55° C ~ +125° C
 CONTACT RESISTANCE: 30 MillioHMS Max.
 COAXIAL PINS: 75 OHM
 SIGNAL PINS: 3 AMPS

MECHANICAL:
 CONTACT INSERTION FORCE: 4.5 Kg Max.
 CONTACT SEPARATOR FORCE: 0.3Kg Min.

MATERIALS:
 CONTACTS: BRASS
 INSULATOR: PBT UL94V-0 RATED,
 230°C PROCESS TEMP.
 SHELL: STEEL

FINISH:
 SHELL: NICKEL

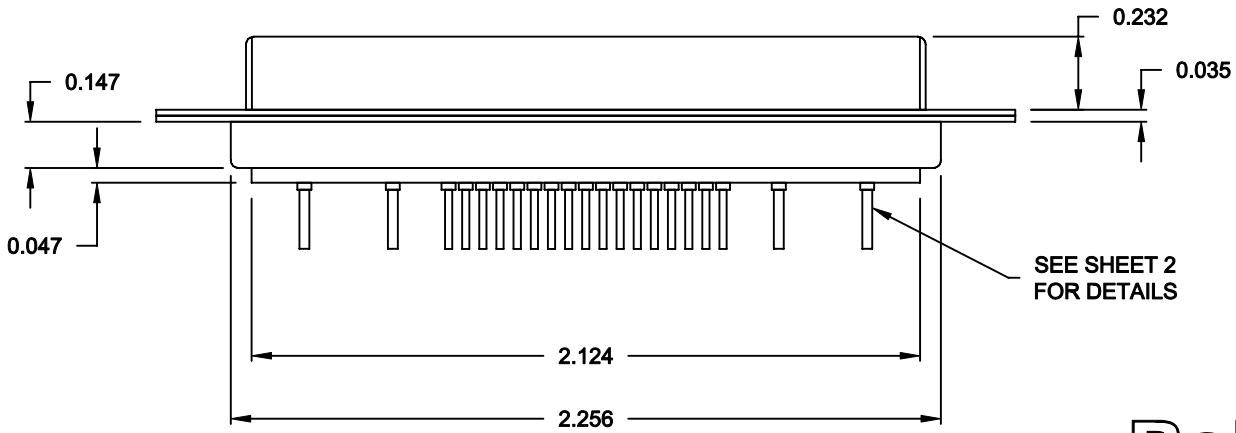
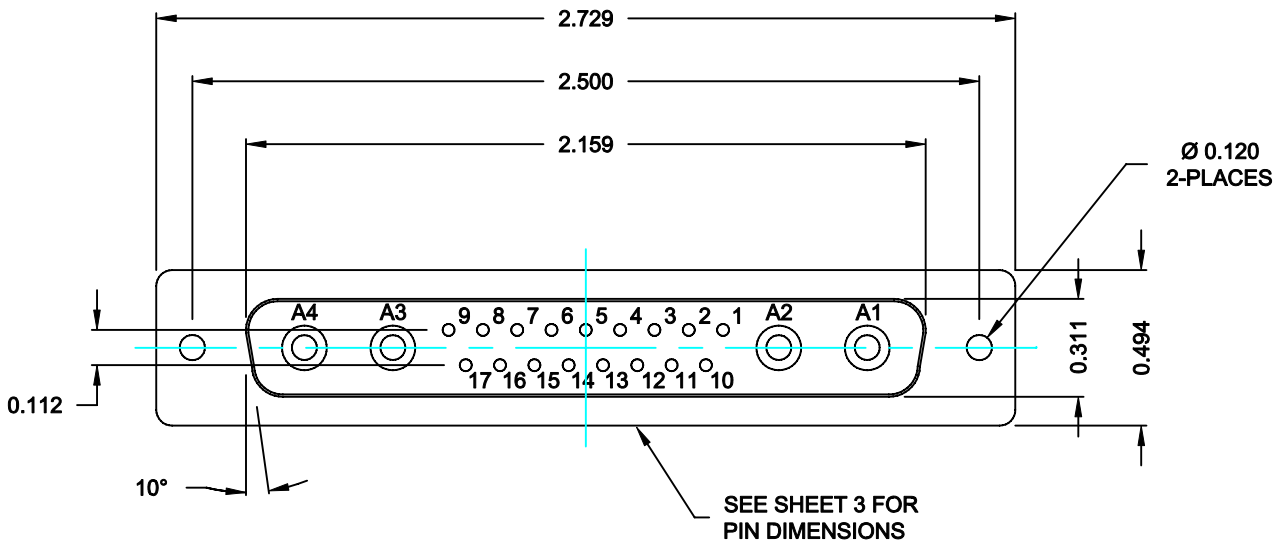

68321WA4SL001

00 = 75 OHM COAXIAL

RoHS COMPLIANT

	THESE DRAWINGS AND SPECIFICATIONS ARE THE PROPERTY OF NorComp AND SHALL NOT BE REPRODUCED, COPIED OR USED AS THE BASIS FOR THE MANUFACTURE OF SALE OF APPARATUS WITHOUT WRITTEN PERMISSION.		DRAWN: C. SMITH	DATE: 10-02-06
			CHECKED: X	DATE: X
NorComp	SCALE: N.T.S.	SHEET 1 OF 2	REV 0	
	DWG NO. 68321WA4SL001			

DESCRIPTION: 683 SERIES CONTACTS

NOTE:
SIGNAL AND COAXIAL CONTACTS
COME PRE-LOADED INTO INSULATORS

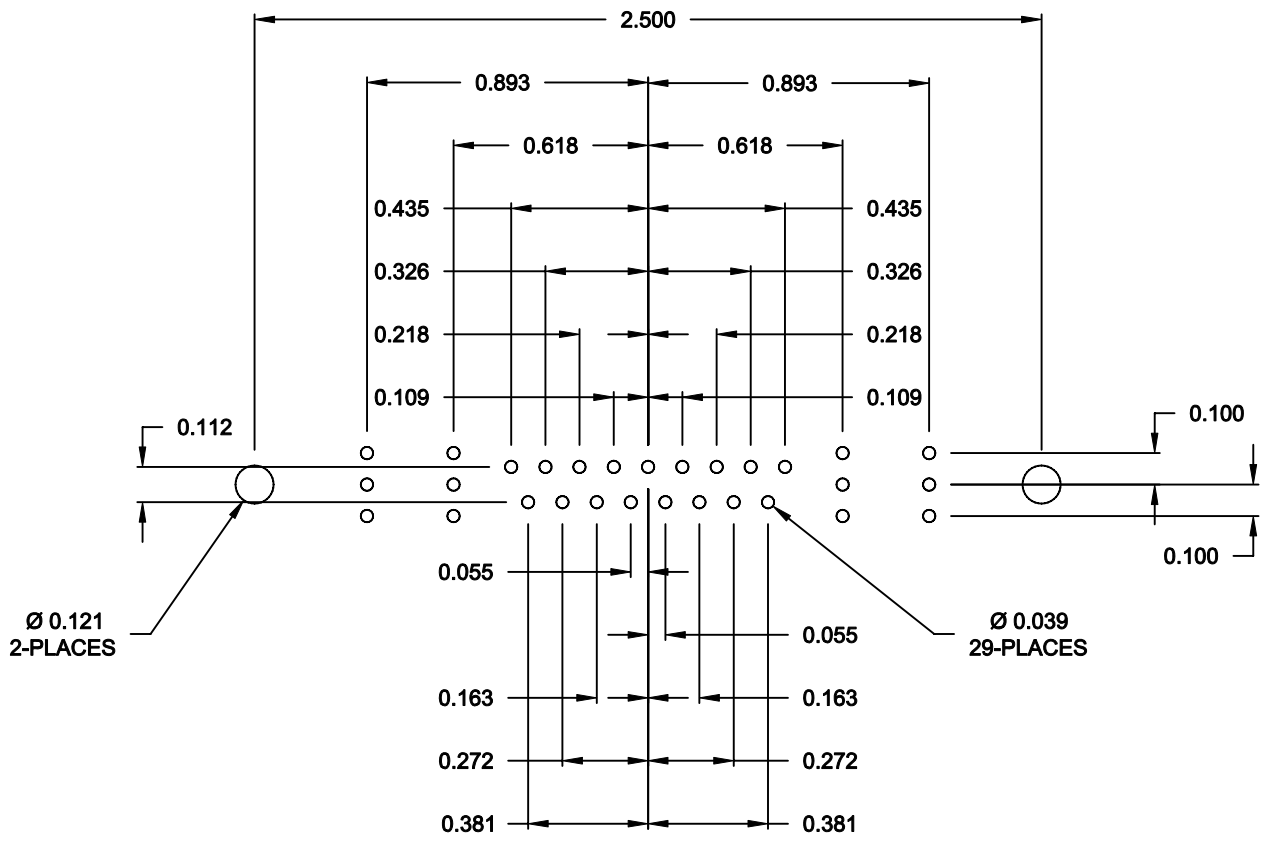

RECOMMENDED PCB LAYOUT

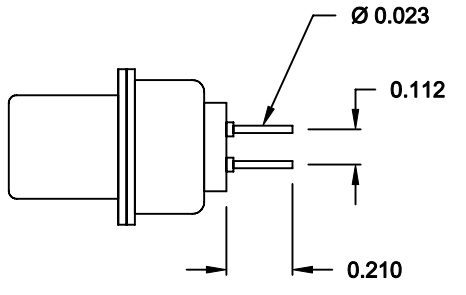

SIGNAL CONTACTS

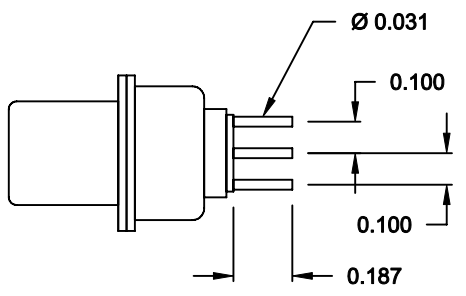

75 OHM COAXIAL CONTACT

RoHS COMPLIANT

	THESE DRAWINGS AND SPECIFICATIONS ARE THE PROPERTY OF NorComp AND SHALL NOT BE REPRODUCED, COPIED OR USED AS THE BASIS FOR THE MANUFACTURE OF SALE OF APPARATUS WITHOUT WRITTEN PERMISSION.		DRAWN: C. SMITH	DATE: 10-02-06
	NorComp		CHECKED: X	DATE: X
SCALE: N.T.S.			SHEET 2 OF 2	REV 0
		DWG NO. 68321WA4SL001		