

DESCRIPTION: COAXIAL / SIGNAL - RIGHT ANGLE - MALE

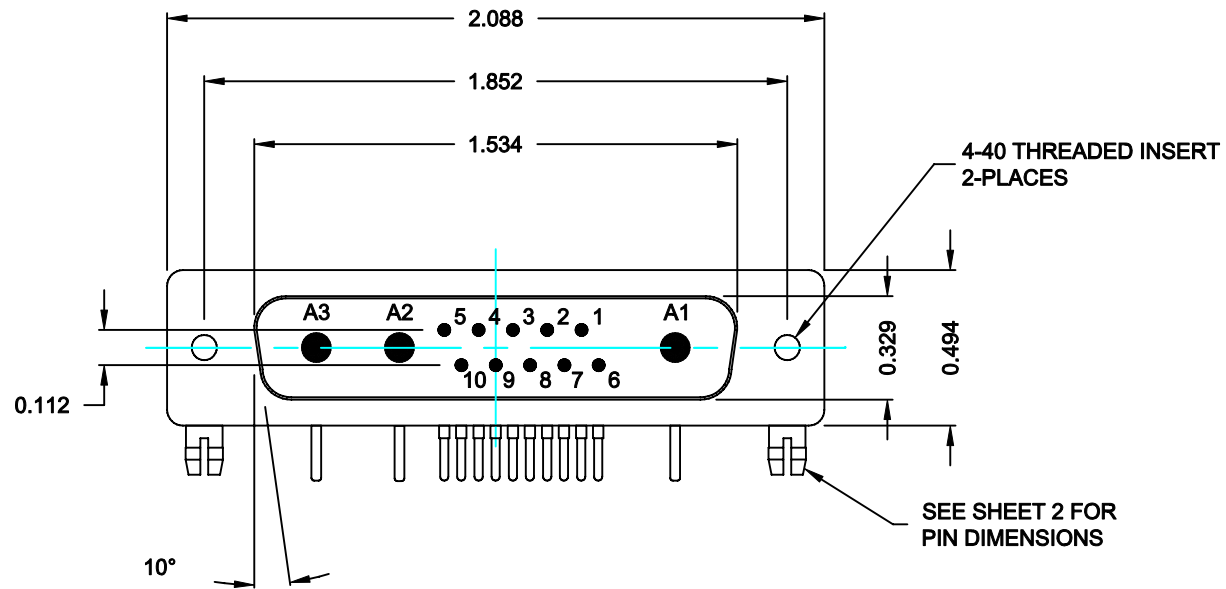

SPECIFICATIONS:

ELECTRICAL:
 INSULATOR RESISTANCE: 5,000 MegOHMS Min.
 DIELECTRIC WITHSTANDING: 1,000VAC r.m.s.
 OPERATING TEMPERATURE: -55° C ~ +125° C
 CONTACT RESISTANCE: 30 MillioHMS Max.
 COAXIAL PINS: 75 OHM
 SIGNAL PINS: 5 AMPS

MECHANICAL:
 CONTACT INSERTION FORCE: 4.5 Kg Max.
 CONTACT SEPARATOR FORCE: 0.3Kg Min.

MATERIALS:
 CONTACTS: BRASS
 INSULATOR: PBT UL94V-0 RATED,
 230°C PROCESS TEMP.
 SHELL: STEEL

FINISH:
 SHELL: NICKEL

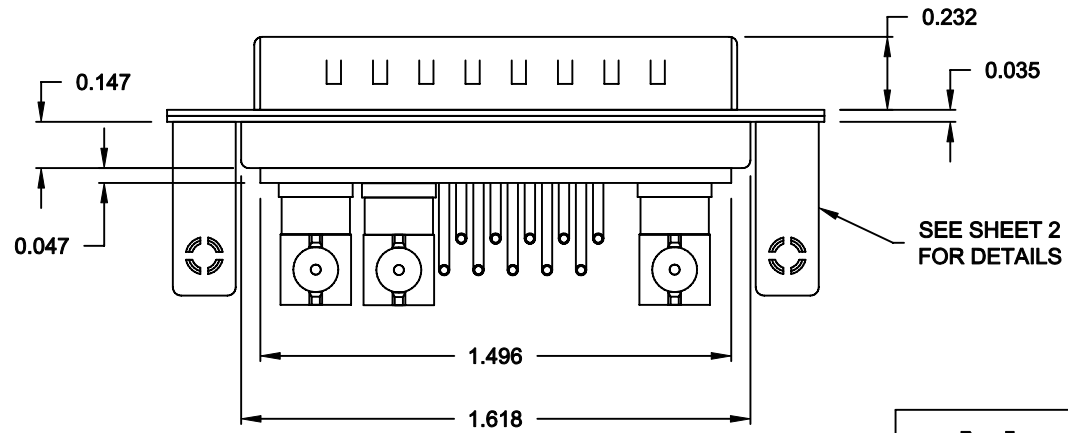

68513W3103L461

46 = 4-40 INSERTS / BOARD LOCKS

RoHS COMPLIANT

	THESE DRAWINGS AND SPECIFICATIONS ARE THE PROPERTY OF NorComp AND SHALL NOT BE REPRODUCED, COPIED OR USED AS THE BASIS FOR THE MANUFACTURE OF SALE OF APPARATUS WITHOUT WRITTEN PERMISSION.		DRAWN: C. SMITH	DATE: 10-11-06
			CHECKED:	DATE:
NorComp		SCALE: N.T.S.	SHEET 1 OF 2	REV 1
		DWG NO. 68513W3103L461		

DESCRIPTION: 685 SERIES CONTACTS

NOTE:
SIGNAL AND COAXIAL CONTACTS
COME PRE-LOADED INTO INSULATORS

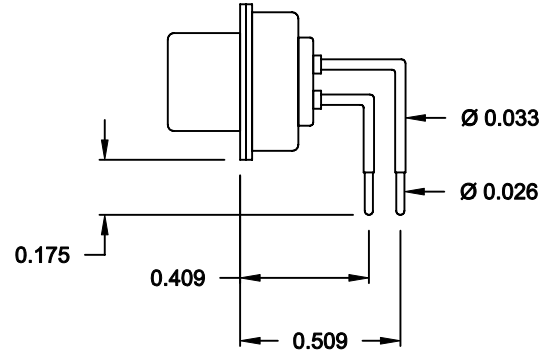
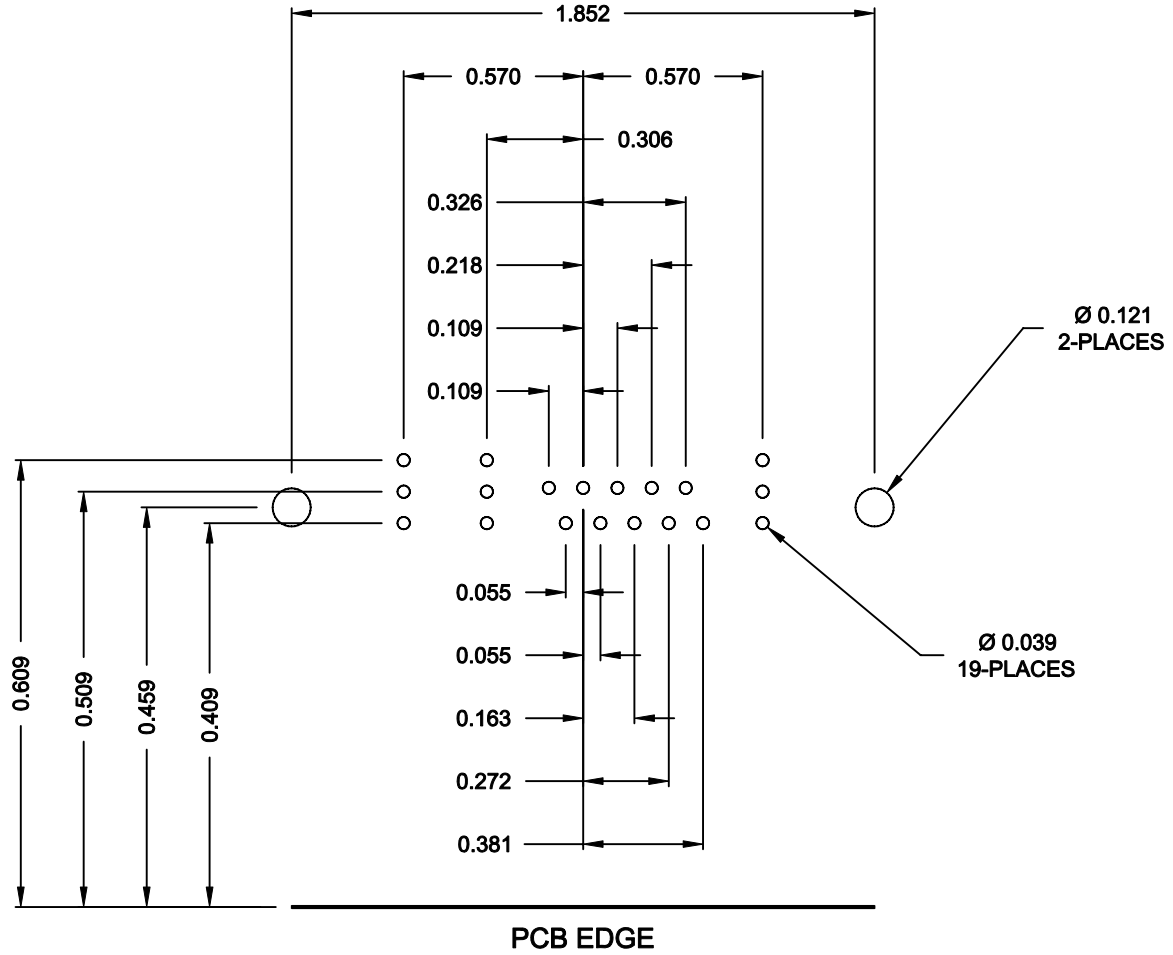

SIGNAL CONTACTS

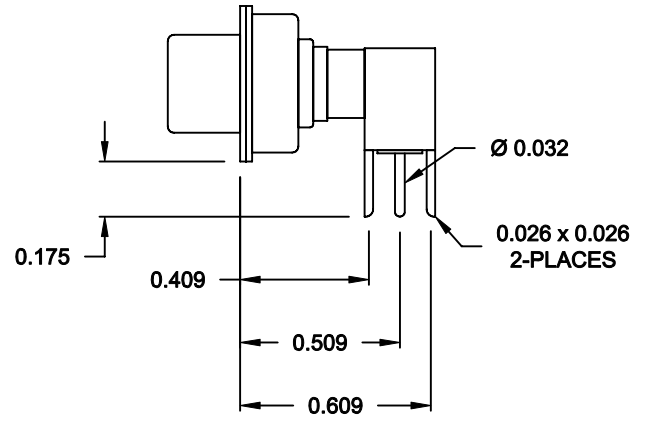

75 OHM COAXIAL CONTACT

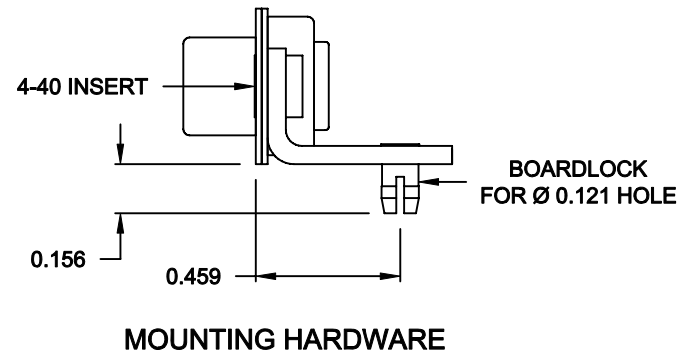

MOUNTING HARDWARE

RoHS COMPLIANT

	THESE DRAWINGS AND SPECIFICATIONS ARE THE PROPERTY OF NorComp AND SHALL NOT BE REPRODUCED, COPIED OR USED AS THE BASIS FOR THE MANUFACTURE OF SALE OF APPARATUS WITHOUT WRITTEN PERMISSION.		DRAWN: C. SMITH	DATE: 10-11-06
			CHECKED:	DATE:
NorComp		SCALE: N.T.S.	SHEET 2 OF 2	REV 1
		DWG NO. 68513W3103L461		