

REV.	CON. NO.	DATE	DRW.	DESCRIPTION

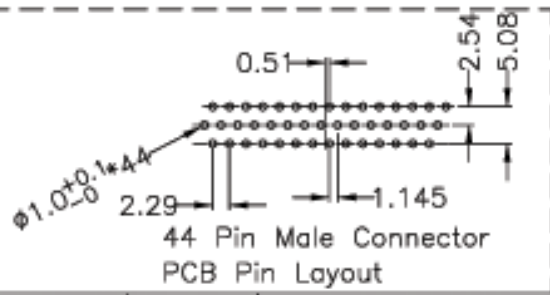

- Note:
- * @Important Dimension. (@為重點尺寸)
 - * Waterproof Rate : IP67
 - * Connector:Black,Nylon+GF
 - * Pin:Copper Alloy,Gold Plated
 - * Do Mating Test After Glued 點膠後,須作對插測試
 - * 注意LOGO為

UNIT:mm		TITLE D-SUB,HD,HD-44PMMP
TOLERANCE X ±0.25 XX ±0.1 XXX ±0.05 ANGLES ±1°	SCALE Free	SHEET 1 OF 1
REV. 01	SIZE A4	@ : Inspection Item

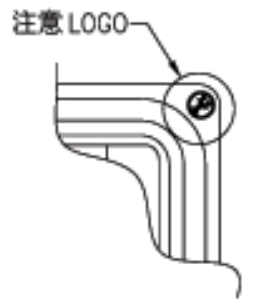
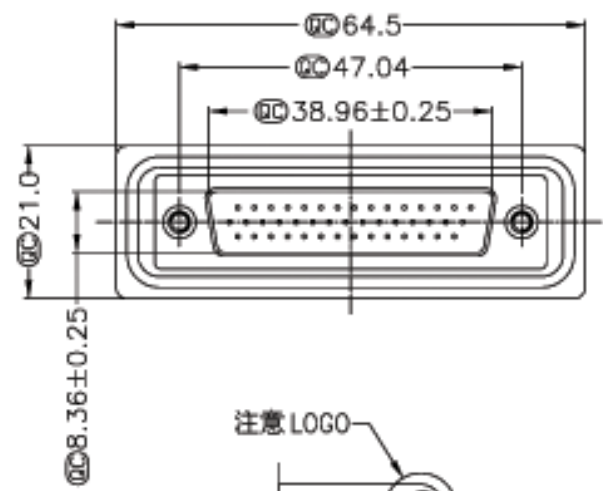
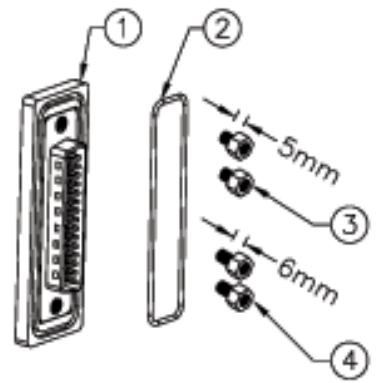
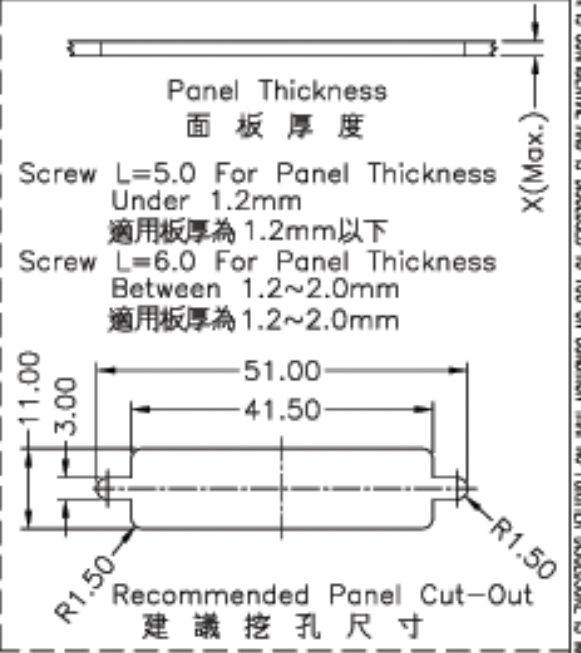
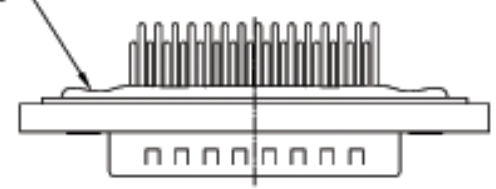
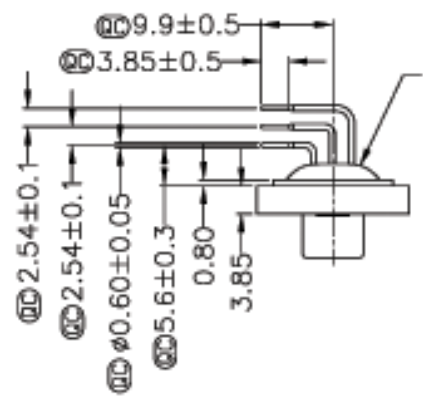

ITEM NO A-HDS-44-AA-WP	DRAWN BY Gao Ling	DATE 2006/05/08
DWG NO A-HDS-44-AA-WP	CHECKED BY Robert Hsu	DATE 2006/05/30
	APPROVED BY Max	DATE 2006/06/02

THIS INFORMATION IS CONFIDENTIAL AND IS DISCLOSED TO YOU ON CONDITION THAT NO FURTHER DISCLOSURE IS MADE BY YOU TO OTHER THAN THE PERSONNEL WITHOUT AUTHORIZATION FROM LITEC CORP.