

SCOTCHLOK™ 557 IDC Electrical Tap Connector

Application:

Use part No. 557 to electrically connect two wire ends and insulate the connection.

Wire Range:

22–16 AWG solid or stranded, (0,5 – 1,0 mm² solid or stranded and 1,5mm² solid)tinned or untinned copper conductors. For use with common thermoplastic insulated wires such as: T, TF, TFF, TFN, TFFN, AWN, TEW, SAE–GPT, with a maximum insulation diameter of .120 inches (3,0 mm).

Maximum recommended current for general purpose applications:

22 AWG – 3 Amps, 20 AWG – 4 Amps,
18 AWG – 7 Amps, 16 AWG – 10 Amps

Construction:

| | |
|-----------|--|
| U–Contact | Tin plated brass, .02 inches thick (0,5 mm) |
| Insulator | Flame retardant polypropylene, color, Red. |

Weight:

.0030 lbs. (1,37 gm)

Engineering Specification:

The connector shall be UL Listed and CSA Certified as a pressure cable connector for 600 volts maximum, building

wire; 1000 volts maximum, signs, fixtures and luminaries. The insulation shall be rated for 105°C. The connector shall also meet the intent of the Standard for Portable Electric Lamps, UL 153, specifically Paragraph 14.2, when housed within the body of the lamp.

Regulatory Agencies:

UL File No. E23438

Tested per UL Standard 486C

CSA File No. LR15503, LR32411

Tested per CSA Standard C22.2 No. 188–M1983

(Voltage rated at 600 volts maximum, building wire; 1000 volts maximum, signs, fixtures, and luminaires. Temperature rated 105°C.)

Federal Specification W – S – 610

* Commercial Packaging Only *









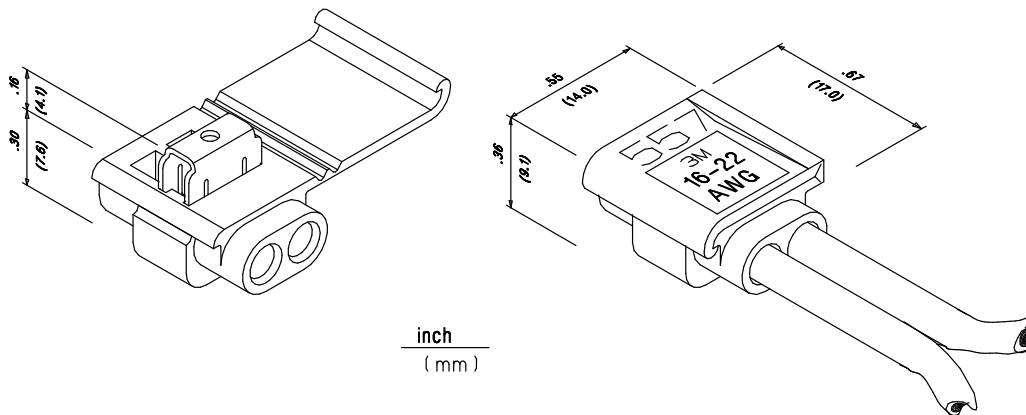





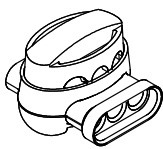
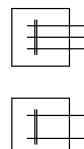

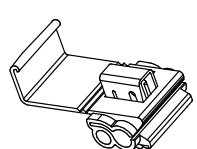



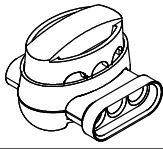
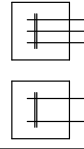

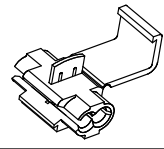

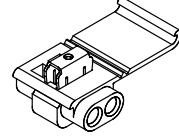



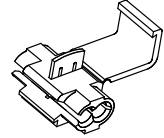

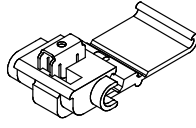



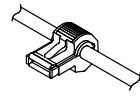



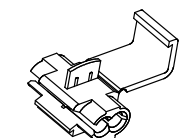
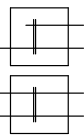

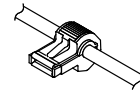



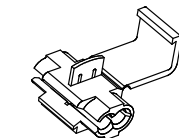
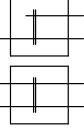

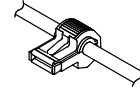



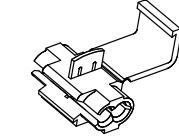

| | | | |
|------|-------|------|-------|
| Type | Class | Kind | Style |
| II | I | cu | F |

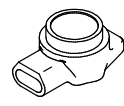
Installation Instruction:

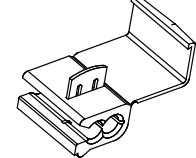
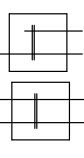
Caution: – Turn power off before installing connectors. All electrical work should be done according to appropriate electrical codes.

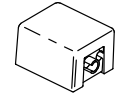
1. Insert unstripped wire completely and check their position in the inspection ports.
2. Hold tool perpendicular to the wire and make the connection by driving the u–connection down flush with the top of the insulator.
3. Close hinged top cover until latched.

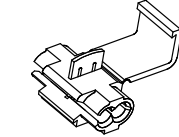

| | Part # Wire Range | Type of Connector |  Listed |  Certified | | Part # Wire Range | Type of Connector |  Listed |  Certified |
|--|-------------------------|---|--|---|---|------------------------------|--|--|---|
|  | 314 22-14 |  |  | |  | 567 12-10run 18-14tap |  |  |  |
|  | 314 22-14 |  |  |  |  | 905 18-14run 22-18Tap |   | | |
|  | 557 22-16 |  |  |  |  | 905N 18-14run 22-18Tap |  | | |
|  | 558 22-16 |  |  |  |  | 951 22-18 |  |  |  |
|  | 560 18-14 |  |  |  |  | 952 18-14 |  |  |  |
|  | 560B 18-14 |  |  | |  | 953 12 |  |  |  |
|  | 560N 18-14 |  |  |  |  | UR 19-26 Solid |   | | |
|  | 562 12-10 |  |  | |  | UB 22-26 Solid |  | | |
|  | 564 18-14 |  | | | NOTE: For complete wire combinations or other technical information see individual data sheets or contact Technical Service. | | | | |

IMPORTANT NOTICE:

All statements, technical information and recommendations related to the Seller's products are based on information believed to be reliable, but the accuracy or completeness thereof is not guaranteed. Before utilizing the product, the user should determine the suitability of the product for its intended use. The user assumes all risks and liability whatsoever in connection with such use.

All statements or recommendations of the seller which are not contained in the Seller's current publications shall have no force or effect unless contained in an agreement signed by an authorized officer of the Seller. The statements contained herein are made in lieu of all warranties express or implied, including but not limited to the implied warranties of merchantability and fitness for a particular purpose which warranties are hereby expressly disclaimed.

© 1991 3M

SELLER SHALL NOT BE LIABLE TO THE USER OR ANY OTHER PERSON UNDER ANY LEGAL THEORY, INCLUDING BUT NOT LIMITED TO NEGLIGENCE OR STRICT LIABILITY, FOR ANY INJURY OR FOR ANY DIRECT OR CONSEQUENTIAL DAMAGES SUSTAINED OR INCURRED BY REASON OF THE USE OF ANY OF THE SELLER'S PRODUCTS.

3M Electrical Products Division

6801 River Place Blvd.
Austin, Texas 78726-4599

7/26/91

