

G2E120 Series Centrifugal Blower

Ø 120mm

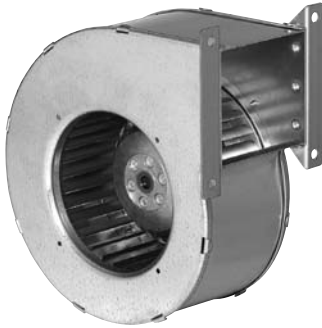

- AC single inlet, forward curved centrifugal blower. Via a bracket, the integrated external-rotor motor is mounted on one side of the housing.
- Housing of die-cast aluminium; impeller of galvanised sheet-steel. Forward curved impellers are directly press-fitted onto the rotor of the external-rotor motor.
- Direction of rotation is CW as seen from suction side. Insulation class "B".
- Maintenance-free ball bearings.
- UL, CSA, VDE approvals on some models, please contact application engineering.

Part Number	Curve	CFM @ 0	VAC	Hertz	Power (W)	dBA	Max Amb. Temp. C	Bearing Type	Features	Capacitor (µF)	Wgt. (lbs)
G2E120-CR21-01	1	150	230	60*	100	63	60	Ball	Leads	2	4.50
G2E120-AR54-43	2	152	115	60	105	62	60	Ball	Leads	6	4.50
G2E120-AR38-43	2	152	230	60	90	62	60	Ball	Leads	2	4.50

* 50 Hz data available.

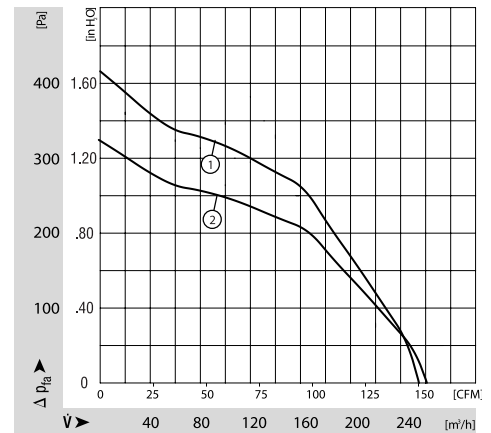
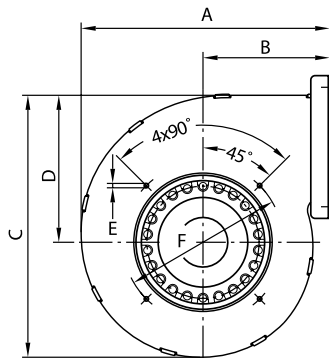

Type	A	B	C	D	E	F	G	H	I	J	K	L	M	N
G2E120-CR	171 (6.73)	87 (3.43)	180 (7.08)	101 (3.98)	3 (0.12)	110 (4.33)	110 (4.33)	94 (3.70)	77 (3.03)	98 (3.86)	82 (3.23)	6 (0.24)	67 (2.64)	99 (3.90)
G2E120-AR	174 (10.0)	82 (9.37)	190 (4.25)	82 (3.62)	M4 -	132 (8.46)	115 (11.8)	100 (6.75)	76 (3.46)	83 (7.09)	68 (3.11)	7 (2.60)	50 (3.11)	98 (2.60)