

# Microwave MLC's

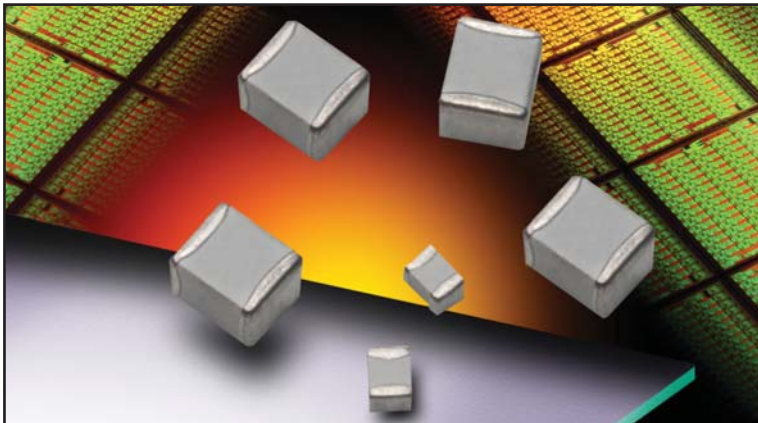

## SQ A Case & B Case Ultra Low ESR MLC



### FEATURES:

- Low ESR
- High Q
- High Self Resonance
- Capacitance Range 0.1 pF to 5100 pF
- 175°C Capability SQCB

### APPLICATIONS:

- RF Power Amplifiers
- Low Noise Amplifiers
- Filter Networks
- MRI Systems

### HOW TO ORDER

<p><b>SQ</b></p> <p>AVX Style</p>	<p><b>CB</b></p> <p><b>Case Size</b> CA = * CB = *</p> <p>* See mechanical dimensions below</p>	<p><b>7</b></p> <p><b>Voltage Code</b> 5 = 50V 1 = 100V E = 150V 2 = 200V V = 250V 9 = 300V 7 = 500V</p>	<p><b>M</b></p> <p><b>Temperature Coefficient Code</b> M = +90±20ppm/°C A = 0±30ppm/°C C = 15% ("J" Termination only)</p>	<p><b>100</b></p> <p><b>Capacitance</b> EIA Capacitance Code in pF. First two digits = significant figures or "R" for decimal place. Third digit = number of zeros or after "R" significant figures.</p>	<p><b>J</b></p> <p><b>Capacitance Tolerance Code</b> B = ±.1 pF C = ±.25 pF D = ±.5 pF F = ±1% G = ±2% J = ±5% K = ±10% M = ±20% N = ±30%</p>	<p><b>A</b></p> <p><b>Failure Rate Code</b> A = Not Applicable</p>	<p><b>T</b></p> <p><b>Termination Style Code</b> **1 = Pd/Ag **7 = Ag/Ni/Au J = Nickel Barrier Sn/Pb (60/40) **T = 100% Tin</p> <p>**RoHS Compliant</p>	<p><b>1A</b></p> <p><b>Packaging Code</b> 1A = 7" Reel Unmarked 6A = Waffle Pack Unmarked ME = 7" Reel Marked WE = Waffle Pack Unmarked</p> <p>* Vertical T&amp;R available * 500 piece reels available</p>
-----------------------------------	---	--	---	--	---	--	---	---

### MECHANICAL DIMENSIONS: inches (millimeters)

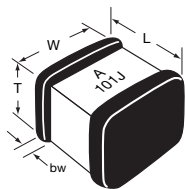

Case	Length (L)	Width (W)	Thickness (T)	Band Width (bw)
SQCA*	.055 + .015 - .010 (1.40+ .381 - .254)	.055±.015 (1.40±.381)	.020/.057 (.508/1.45)	.010 + .010 - .005 (.254 + .254 - .127)
SQCB*	.110 + .020 - .010 (2.79 + .508 - .254)	.110±.010 (2.79±.254)	.030/.102 (.762/2.59)	.015±.010 (.381±.254)

**TAPE & REEL:** All tape and reel specifications are in compliance with EIA RS481 (equivalent to IEC 286 part 3).

- 8mm carrier
- 7" reel: SQCA/SQCB = 2000 pcs (500 piece reels SQCA SQCB)

### WAFFLE PACK

- SQCA 100 pcs
- SQCB 80 pcs



### ELECTRICAL SPECIFICATIONS

	M & A	C
Temperature Coefficient (TCC)	(M) $+90 \pm 20$ PPM/°C ( -55°C to +125°C) (M) $+90 \pm 30$ PPM/°C ( +125°C to +175°C)* (A) $0 \pm 30$ PPM/°C	$\pm 15\%$ (-55°C to 125°C)
Capacitance Range	(M) 0.1 pF to 1000 pF (A) 0.1 pF to 5100 pF	0.001 $\mu$ F to 0.1 $\mu$ F
Operating Temperature	0.1 pF to 330 pF: from -55°C to +175°C* 360 pF to 5100 pF: from -55°C to +125°C	-55°C to +125°C
Quality Factor (Q)	Greater than 10,000 at 1 MHz	2.5% @ 1kHz
Insulation Resistance (IR)	0.2 pF to 470 pF 10 <sup>6</sup> Megohms min. @ 25°C at rated WVDC 10 <sup>5</sup> Megohms min. @ 125°C at rated WVDC 510 pF to 5100 pF 10 <sup>5</sup> Megohms min. @ 25°C at rated WVDC 10 <sup>4</sup> Megohms min. @ 125°C at rated WVDC	10 <sup>4</sup> Megohms min. @ 25°C at rated WVDC 10 <sup>3</sup> Megohms min. @ 125°C at rated WVDC
Working Voltage (WVDC)	See Capacitance Values table	See Capacitance Values table
Dielectric Withstanding Voltage (DWW)	250% of rated WVDC for 5 secs (for 500V rated 150% of rated voltage)	250% of rated WVDC for 5 secs
Aging Effects	None	<3% per decade hour
Piezoelectric Effects	None	None
Capacitance Drift	$\pm$ (0.02% or 0.02 pF), whichever is greater	Not Applicable

\* 175 SQCB & SQLB only

### ENVIRONMENTAL CHARACTERISTICS

AVX SQ will meet and exceed the requirements of EIA-198, MIL-PRF-55681 and MIL-PRF-123

Thermal Shock	Mil-STD-202, Method 107, Condition A
Moisture Resistance	Mil-STD-202, Method 106
Low Voltage Humidity	Mil-STD-202, Method 103, condition A, with 1.5 VDC applied while subjected to an environment of 85°C with 85% relative humidity for 240 hours
Life Test	Mil-STD-202, Method 108, for 2000 hours at 125°C
Shock	Mil-STD-202, Method 213, Condition J
Vibration	Mil-STD-202, Method 204, Condition B
Immersion	Mil-STD-202, Method 104, Condition B
Salt Spray	Mil-STD-202, Method 101, Condition B
Solderability	Mil-STD-202, Method 208
Terminal Strength	Mil-STD-202, Method 211
Temperature Cycling	Mil-STD-202, Method 102, Condition C
Barometric Pressure	Mil-STD-202, Method 105, Condition B
Resistance to Solder Heat	Mil-STD-202, Method 210, Condition C

### Case Size A

**TABLE I: TC: M (+90±20PPM/°C)**

Cap. pF	Cap. Tol.	WVDC	Cap. pF	Cap. Tol.	WVDC	Cap. pF	Cap. Tol.	WVDC	Cap. pF	Cap. Tol.	WVDC
0.1	B	150	1.7	B, C, D	150	6.2	B, C, D	150	27	F, G, J, K	150
0.2	B	150	1.8	B, C, D	150	6.8	B, C, J, K	150	30	F, G, J, K	150
0.3	B,C	150	1.9	B, C, D	150	7.5	B, C, J, K	150	33	F, G, J, K	150
0.4	B,C	150	2.0	B, C, D	150	8.2	B, C, J, K	150	36	F, G, J, K	150
0.5	B, C, D	150	2.2	B, C, D	150	9.1	B, C, J, K	150	39	F, G, J, K	150
0.6	B, C, D	150	2.4	B, C, D	150	10	F, G, J, K	150	43	F, G, J, K	150
0.7	B, C, D	150	2.7	B, C, D	150	11	F, G, J, K	150	47	F, G, J, K	150
0.8	B, C, D	150	3.0	B, C, D	150	12	F, G, J, K	150	51	F, G, J, K	150
0.9	B, C, D	150	3.3	B, C, D	150	13	F, G, J, K	150	56	F, G, J, K	150
1.0	B, C, D	150	3.6	B, C, D	150	15	F, G, J, K	150	62	F, G, J, K	150
1.1	B, C, D	150	3.9	B, C, D	150	16	F, G, J, K	150	68	F, G, J, K	150
1.2	B, C, D	150	4.3	B, C, D	150	18	F, G, J, K	150	75	F, G, J, K	150
1.3	B, C, D	150	4.7	B, C, D	150	20	F, G, J, K	150	82	F, G, J, K	150
1.4	B, C, D	150	5.1	B, C, D	150	22	F, G, J, K	150	91	F, G, J, K	150
1.5	B, C, D	150	5.6	B, C, D	150	24	F, G, J, K	150	100	F, G, J, K	150
1.6	B, C, D	150									

**TABLE II: TC: A (0±30PPM/°C)**

Cap. pF	Cap. Tol.	WVDC	Cap. pF	Cap. Tol.	WVDC	Cap. pF	Cap. Tol.	WVDC	Cap. pF	Cap. Tol.	WVDC
0.1	B	150	2.7	B, C, D	150	20	F, G, J, K	150	150	F, G, J, K	50
0.2	B	150	3.0	B, C, D	150	22	F, G, J, K	150	160	F, G, J, K	50
0.3	B,C	150	3.3	B, C, D	150	24	F, G, J, K	150	180	F, G, J, K	50
0.4	B,C	150	3.6	B, C, D	150	27	F, G, J, K	150	200	F, G, J, K	50
0.5	B, C, D	150	3.9	B, C, D	150	30	F, G, J, K	150	220	F, G, J, K	50
0.6	B, C, D	150	4.3	B, C, D	150	33	F, G, J, K	150	240	F, G, J, K	50
0.7	B, C, D	150	4.7	B, C, D	150	36	F, G, J, K	150	270	F, G, J, K	50
0.8	B, C, D	150	5.1	B, C, D	150	39	F, G, J, K	150	300	F, G, J, K	50
0.9	B, C, D	150	5.6	B, C, D	150	43	F, G, J, K	150	330	F, G, J, K	50
1.0	B, C, D	150	6.2	B, C, D	150	47	F, G, J, K	150	360	F, G, J, K	50
1.1	B, C, D	150	6.8	B, C, J, K	150	51	F, G, J, K	150	390	F, G, J, K	50
1.2	B, C, D	150	7.5	B, C, J, K	150	56	F, G, J, K	150	430	F, G, J, K	50
1.3	B, C, D	150	8.2	B, C, J, K	150	62	F, G, J, K	150	470	F, G, J, K	50
1.4	B, C, D	150	9.1	B, C, J, K	150	68	F, G, J, K	150	510	F, G, J, K	50
1.5	B, C, D	150	10	F, G, J, K	150	75	F, G, J, K	150	560	F, G, J, K	50
1.6	B, C, D	150	11	F, G, J, K	150	82	F, G, J, K	150	620	F, G, J, K	50
1.7	B, C, D	150	12	F, G, J, K	150	91	F, G, J, K	150	680	F, G, J, K	50
1.8	B, C, D	150	13	F, G, J, K	150	100	F, G, J, K	150	750	F, G, J, K	50
1.9	B, C, D	150	15	F, G, J, K	150	110	F, G, J, K	50	820	F, G, J, K	50
2.0	B, C, D	150	16	F, G, J, K	150	120	F, G, J, K	50	910	F, G, J, K	50
2.2	B, C, D	150	18	F, G, J, K	150	130	F, G, J, K	50	1000	F, G, J, K	50
2.4	B, C, D	150									

**TABLE III: TC: C (±15%)**

Cap. pF	Cap. Tol.	WVDC	Cap. pF	Cap. Tol.	WVDC	Cap. pF	Cap. Tol.	WVDC
1000	K, M, N	50	2200	K, M, N	50	5100	K, M, N	50
1200	K, M, N	50	2700	K, M, N	50	5600	K, M, N	50
1500	K, M, N	50	3300	K, M, N	50	6800	K, M, N	50
1800	K, M, N	50	3900	K, M, N	50	8200	K, M, N	50
2000	K, M, N	50	4700	K, M, N	50	10000	K, M, N	50

### Case Size B

**TABLE IV: TC: M (+90±20PPM/°C)**

Cap. pF	Cap. Tol.	WVDC	Cap. pF	Cap. Tol.	WVDC	Cap. pF	Cap. Tol.	WVDC	Cap. pF	Cap. Tol.	WVDC
0.1	B	500	2.7	B, C, D	500	20	F, G, J, K	500	150	F, G, J, K	300
0.2	B	500	3.0	B, C, D	500	22	F, G, J, K	500	160	F, G, J, K	300
0.3	B,C	500	3.3	B, C, D	500	24	F, G, J, K	500	180	F, G, J, K	300
0.4	B,C	500	3.6	B, C, D	500	27	F, G, J, K	500	200	F, G, J, K	300
0.5	B, C, D	500	3.9	B, C, D	500	30	F, G, J, K	500	220	F, G, J, K	200
0.6	B, C, D	500	4.3	B, C, D	500	33	F, G, J, K	500	240	F, G, J, K	200
0.7	B, C, D	500	4.7	B, C, D	500	36	F, G, J, K	500	270	F, G, J, K	200
0.8	B, C, D	500	5.1	B, C, D	500	39	F, G, J, K	500	300	F, G, J, K	200
0.9	B, C, D	500	5.6	B, C, D	500	43	F, G, J, K	500	330	F, G, J, K	200
1.0	B, C, D	500	6.2	B, C, D	500	47	F, G, J, K	500	360	F, G, J, K	200
1.1	B, C, D	500	6.8	B, C, J, K	500	51	F, G, J, K	500	390	F, G, J, K	200
1.2	B, C, D	500	7.5	B, C, J, K	500	56	F, G, J, K	500	430	F, G, J, K	200
1.3	B, C, D	500	8.2	B, C, J, K	500	62	F, G, J, K	500	470	F, G, J, K	200
1.4	B, C, D	500	9.1	B, C, J, K	500	68	F, G, J, K	500	510	F, G, J, K	150
1.5	B, C, D	500	10	F, G, J, K	500	75	F, G, J, K	500	560	F, G, J, K	150
1.6	B, C, D	500	11	F, G, J, K	500	82	F, G, J, K	500	620	F, G, J, K	150
1.7	B, C, D	500	12	F, G, J, K	500	91	F, G, J, K	500	680	F, G, J, K	150
1.8	B, C, D	500	13	F, G, J, K	500	100	F, G, J, K	500	750	F, G, J, K	150
1.9	B, C, D	500	15	F, G, J, K	500	110	F, G, J, K	300	820	F, G, J, K	150
2.0	B, C, D	500	16	F, G, J, K	500	120	F, G, J, K	300	910	F, G, J, K	150
2.2	B, C, D	500	18	F, G, J, K	500	130	F, G, J, K	300	1000	F, G, J, K	150
2.4	B, C, D	500									

**TABLE V: TC: A (0±30PPM/°C)**

Cap. pF	Cap. Tol.	WVDC	Cap. pF	Cap. Tol.	WVDC	Cap. pF	Cap. Tol.	WVDC	Cap. pF	Cap. Tol.	WVDC
0.1	B	500	3.9	B, C, D	500	47	F, G, J, K	500	560	F, G, J, K	150
0.2	B	500	4.3	B, C, D	500	51	F, G, J, K	500	620	F, G, J, K	150
0.3	B,C	500	4.7	B, C, D	500	56	F, G, J, K	500	680	F, G, J, K	150
0.4	B,C	500	5.1	B, C, D	500	62	F, G, J, K	500	750	F, G, J, K	150
0.5	B, C, D	500	5.6	B, C, D	500	68	F, G, J, K	500	820	F, G, J, K	150
0.6	B, C, D	500	6.2	B, C, D	500	75	F, G, J, K	500	910	F, G, J, K	150
0.7	B, C, D	500	6.8	B, C, J, K	500	82	F, G, J, K	500	1000	F, G, J, K	150
0.8	B, C, D	500	7.5	B, C, J, K	500	91	F, G, J, K	500	1100	F, G, J, K	50
0.9	B, C, D	500	8.2	B, C, J, K	500	100	F, G, J, K	500	1200	F, G, J, K	50
1.0	B, C, D	500	9.1	B, C, J, K	500	110	F, G, J, K	300	1300	F, G, J, K	50
1.1	B, C, D	500	10	F, G, J, K	500	120	F, G, J, K	300	1500	F, G, J, K	50
1.2	B, C, D	500	11	F, G, J, K	500	130	F, G, J, K	300	1600	F, G, J, K	50
1.3	B, C, D	500	12	F, G, J, K	500	150	F, G, J, K	300	1800	F, G, J, K	50
1.4	B, C, D	500	13	F, G, J, K	500	160	F, G, J, K	300	2000	F, G, J, K	50
1.5	B, C, D	500	15	F, G, J, K	500	180	F, G, J, K	300	2200	F, G, J, K	50
1.6	B, C, D	500	16	F, G, J, K	500	200	F, G, J, K	300	2400	F, G, J, K	50
1.7	B, C, D	500	18	F, G, J, K	500	220	F, G, J, K	200	2700	F, G, J, K	50
1.8	B, C, D	500	20	F, G, J, K	500	240	F, G, J, K	200	3000	F, G, J, K	50
1.9	B, C, D	500	22	F, G, J, K	500	270	F, G, J, K	200	3300	F, G, J, K	50
2.0	B, C, D	500	24	F, G, J, K	500	300	F, G, J, K	200	3600	F, G, J, K	50
2.2	B, C, D	500	27	F, G, J, K	500	330	F, G, J, K	200	3900	F, G, J, K	50
2.4	B, C, D	500	30	F, G, J, K	500	360	F, G, J, K	200	4300	F, G, J, K	50
2.7	B, C, D	500	33	F, G, J, K	500	390	F, G, J, K	200	4700	F, G, J, K	50
3.0	B, C, D	500	36	F, G, J, K	500	430	F, G, J, K	200	5000	F, G, J, K	50
3.3	B, C, D	500	39	F, G, J, K	500	470	F, G, J, K	200	5100	F, G, J, K	50
3.6	B, C, D	500	43	F, G, J, K	500	510	F, G, J, K	150			

**TABLE VI: TC: C (±15%)**

Cap. pF	Cap. Tol.	WVDC	Cap. pF	Cap. Tol.	WVDC	Cap. pF	Cap. Tol.	WVDC
5000	K, M, N	50	15000	K, M, N	50	47000	K, M, N	50
6800	K, M, N	50	18000	K, M, N	50	68000	K, M, N	50
8200	K, M, N	50				82000	K, M, N	50
10000	K, M, N	50	27000	K, M, N	50	100000	K, M, N	50
12000	K, M, N	50	33000	K, M, N	50			
			39000	K, M, N	50			

6

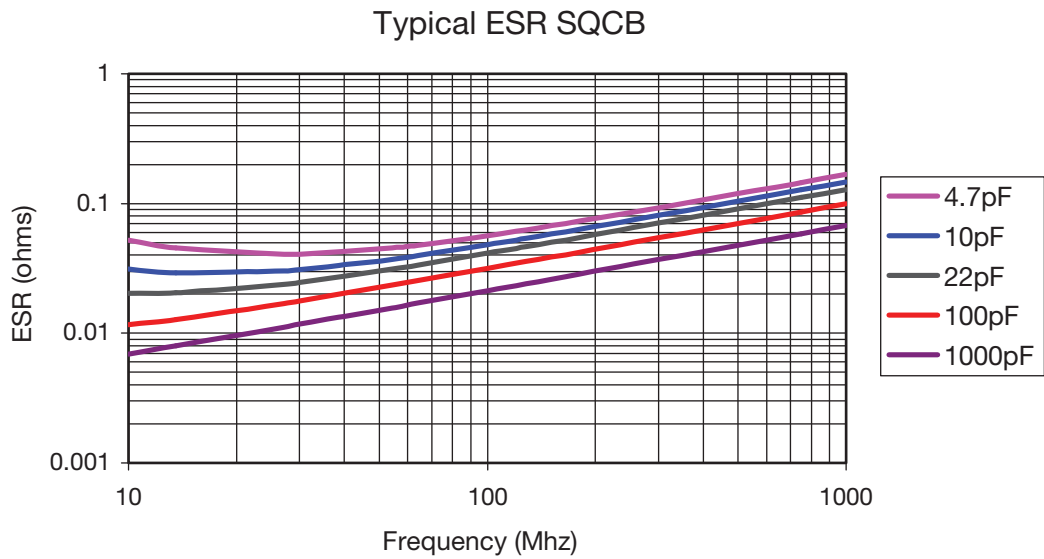
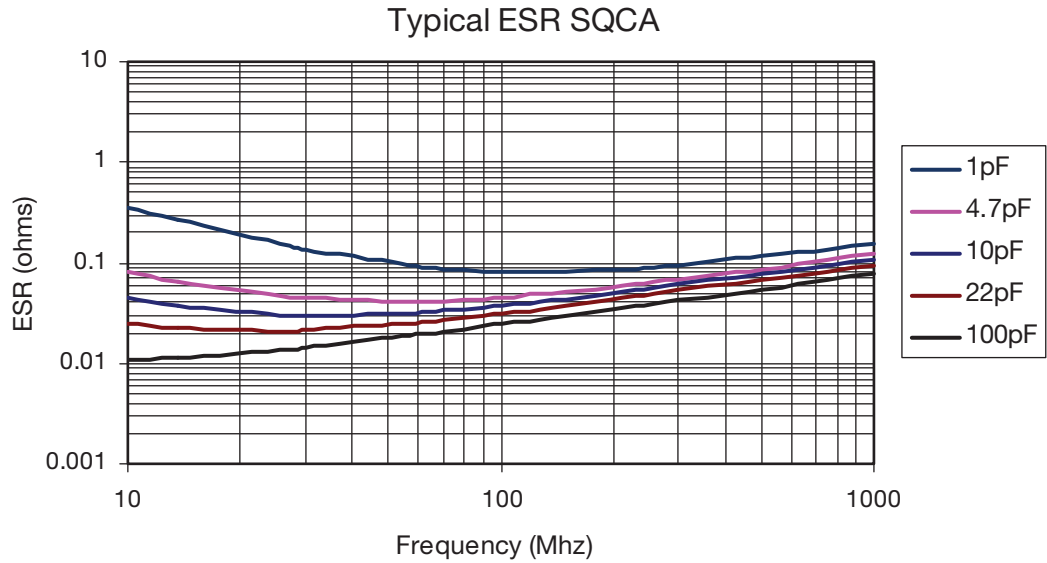

6

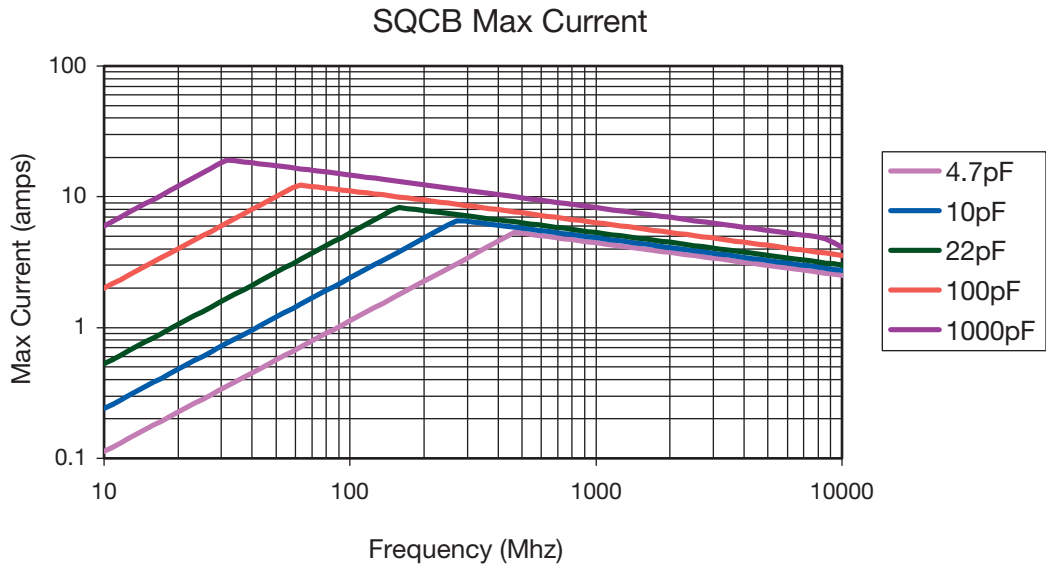
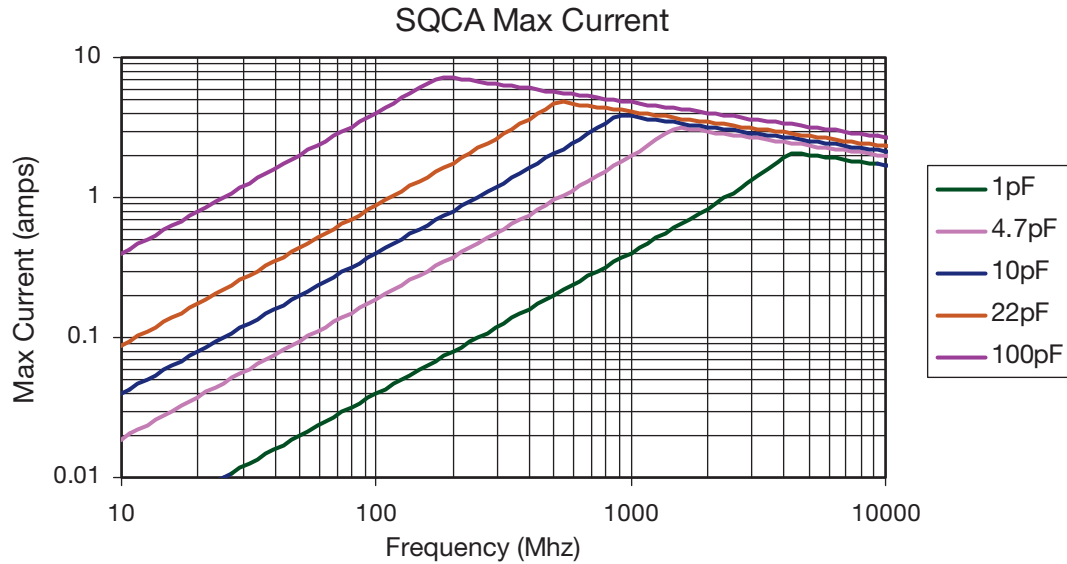

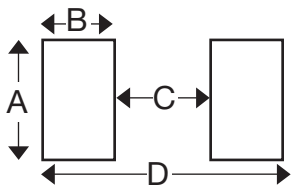
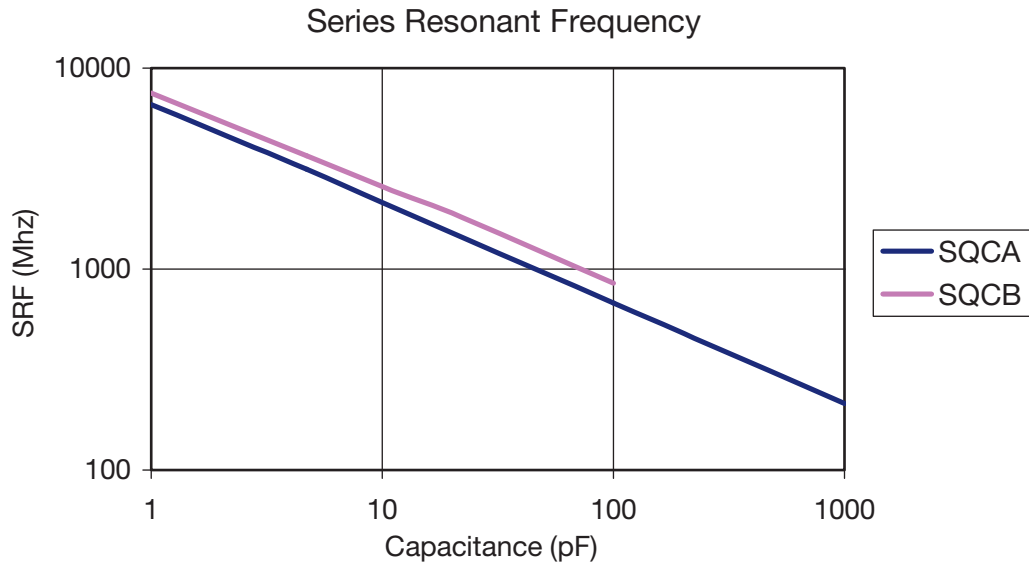

### MOUNTING PAD DIMENSIONS: inches (millimeters)

Case	A min	B min	C min	D min
SQCA	0.082 (2.083)	0.051 (1.295)	0.032 (0.813)	0.130 (3.302)
SQCB	0.131 (3.327)	0.051 (1.295)	0.074 (1.880)	0.177 (4.496)
SQCS	0.038 (0.965)	0.043 (1.092)	0.025 (0.635)	0.112 (2.845)
SQCF	0.059 (1.499)	0.051 (1.295)	0.024 (0.610)	0.125 (3.175)

### SQCA & SQCB ENGINEERING KITS

PN	Series	Diel	Term	Range	Different Values	# per value
Kit SQ005 T	SQCA	P90	100% Tin RoHS	.1 to 10pF	27	20
Kit SQ006 T				10 to 100pF	16	
Kit SQ009 T	SQCA	C0G	100% Tin RoHS	100 to 1000pF	16	15
Kit SQ010 T	SQCB	P90	100% Tin RoHS	.1 to 22pF	32	15
Kit SQ011 T				10 to 1000pF	31	
Kit SQ014 T	SQCB	C0G	100% Tin RoHS	470 to 5100pF	31	15
Kit SQ001	SQCB	P90	Sn/Pb	1 to 1000pF	46	10
Kit SQ002	SQCA	P90	Sn/Pb	.1 to 2pF	17	10
Kit SQ003				2.2 to 10pF	22	

Tolerance per PF:	
B from .1 to 3.3	J from 10 to 1800
C from 3.9 to 8.2	K above 1800

# Microwave MLC's



## SQCS (0603) SQCF (0805) Ultra Low ESR MLC

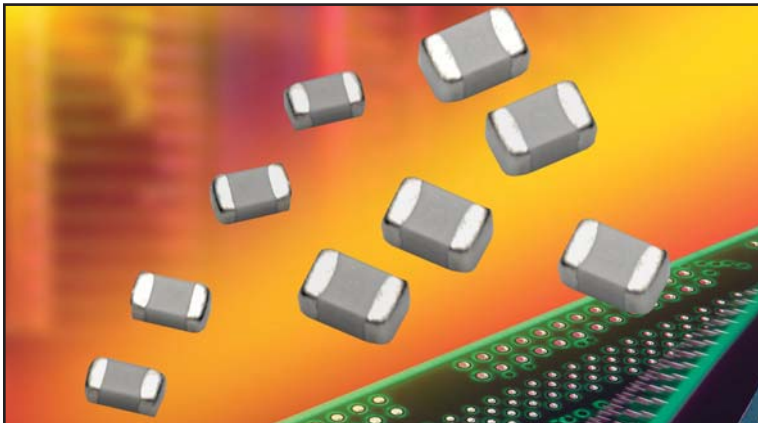

### FEATURES:

- Low ESR
- High Q
- High Self Resonance
- Capacitance Range 0.1 pF to 240 pF
- EIA Size

### APPLICATIONS:

- RF Power Amplifiers
- Low Noise Amplifiers
- Filter Networks
- Point to Point Radios

### HOW TO ORDER

<p><b>SQ</b></p> <p>AVX Style</p>	<p><b>CS</b></p> <p>Case Size CS = 0603 CF = 0805</p>	<p><b>V</b></p> <p>Voltage Code V = 250V</p>	<p><b>A</b></p> <p>Temperature Coefficient Code A = 0±30ppm/°C</p>	<p><b>100</b></p> <p>Capacitance EIA Capacitance Code in pF. First two digits = significant figures or "R" for decimal place. Third digit = number of zeros or after "R" significant figures.</p>	<p><b>J</b></p> <p>Capacitance Tolerance Code A = ±.05 pF B = ±.1 pF C = ±.25 pF D = ±.5 pF F = ±1% G = ±2% J = ±5%</p>	<p><b>A</b></p> <p>Failure Rate Code A = Not Applicable</p>	<p><b>T</b></p> <p>Termination Style Code **1 = Pd/Ag **7 = Ag/Ni/Au J = Nickel Barrier Sn/Pb (60/40) **T = 100% Tin (Standard)</p>	<p><b>1A</b></p> <p>Packaging Code 1A = 7" Reel Unmarked ME = 7" Reel Marked</p> <p>* Vertical T&amp;R available * 500 piece reels available</p>
-----------------------------------	---	--	--	---	---	---	---	--

\*\*RoHS Compliant

6

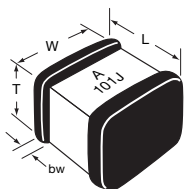

### MECHANICAL DIMENSIONS: inches (millimeters)

Case	Length (L)	Width (W)	Thickness (T)	Band Width (bw)
SQCS	.063±.006 (1.60±.152)	.032±.006 (.813±.152)	.030 Max. (.762)	.014±.006 (.357±.152)
SQCF	.079±.008 (2.01±.200)	.049±.008 (1.24±.200)	.045 Max. (1.14)	.014±.006 (.357±.152)

**TAPE & REEL:** All tape and reel specifications are in compliance with EIA RS481 (equivalent to IEC 286 part 3).

- 8mm carrier
- 7" reel = 4000 pcs (500 piece options)

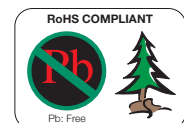



# Microwave MLC's

## Low ESR MLC Capacitors



### ELECTRICAL SPECIFICATIONS

Temperature Coefficient (TCC)	(A) $0 \pm 30$ PPM/°C
Operating Temperature	-55°C to +125°C
Quality Factor (Q)	Greater than 10,000 at 1 MHz
Insulation Resistance (IR)	0.1 pF to 240 pF 10 <sup>9</sup> Megohms min. @ 25°C at rated WVDC 10 <sup>8</sup> Megohms min. @ 125°C at rated WVDC
Working Voltage (WVDC)	See Capacitance Values table
Dielectric Withstanding Voltage (DWV)	250% of rated WVDC for 5 secs
Aging Effects	None
Piezoelectric Effects	None
Capacitance Drift	$\pm (0.02\% \text{ or } 0.02 \text{ pF})$ , whichever is greater

### ENVIRONMENTAL CHARACTERISTICS

AVX SQ will meet and exceed the requirements of EIA-198, MIL-PRF-55681 and MIL-PRF-123

Thermal Shock	Mil-STD-202, Method 107, Condition A
Moisture Resistance	Mil-STD-202, Method 106
Low Voltage Humidity	Mil-STD-202, Method 103, condition A, with 1.5 VDC applied while subjected to an environment of 85°C with 85% relative humidity for 240 hours
Life Test	Mil-STD-202, Method 108, for 2000 hours at 125°C
Shock	Mil-STD-202, Method 213, Condition J
Vibration	Mil-STD-202, Method 204, Condition B
Immersion	Mil-STD-202, Method 104, Condition B
Salt Spray	Mil-STD-202, Method 101, Condition B
Solderability	Mil-STD-202, Method 208
Terminal Strength	Mil-STD-202, Method 211
Temperature Cycling	Mil-STD-202, Method 102, Condition C
Barometric Pressure	Mil-STD-202, Method 105, Condition B
Resistance to Solder Heat	Mil-STD-202, Method 210, Condition C

# Microwave MLC's



## SQ Series Available Capacitance/Size/WVDC/T.C.

**TABLE I: TC: A (0±30PPM/°C) CASE SIZE S**

Cap. pF	Cap. Tol.	WVDC	Cap. pF	Cap. Tol.	WVDC	Cap. pF	Cap. Tol.	WVDC
0.1	A, B	250	2.4	A, B, C	250	18	F, G, J	250
0.2	A, B	250	2.7	A, B, C	250	20	F, G, J	250
0.3	A, B	250	3.0	A, B, C	250	22	F, G, J	250
0.4	A, B	250	3.3	A, B, C	250	24	F, G, J	250
0.5	A, B, C	250	3.6	A, B, C	250	27	F, G, J	250
0.6	A, B, C	250	3.9	A, B, C	250	30	F, G, J	250
0.7	A, B, C	250	4.3	A, B, C	250	33	F, G, J	250
0.8	A, B, C	250	4.7	A, B, C	250	36	F, G, J	250
0.9	A, B, C	250	5.1	A, B, C	250	39	F, G, J	250
1.0	A, B, C	250	5.6	A, B, C	250	43	F, G, J	250
1.1	A, B, C	250	6.2	A, B, C	250	47	F, G, J	250
1.2	A, B, C	250	6.8	B, C, D	250	51	F, G, J	250
1.3	A, B, C	250	7.5	B, C, D	250	56	F, G, J	250
1.4	A, B, C	250	8.2	B, C, D	250	62	F, G, J	250
1.5	A, B, C	250	9.1	B, C, D	250	68	F, G, J	250
1.6	A, B, C	250	10	F, G, J	250	75	F, G, J	250
1.7	A, B, C	250	11	F, G, J	250	82	F, G, J	250
1.8	A, B, C	250	12	F, G, J	250	91	F, G, J	250
1.9	A, B, C	250	13	F, G, J	250	100	F, G, J	250
2.0	A, B, C	250	15	F, G, J	250			
2.2	A, B, C	250	16	F, G, J	250			

**TABLE II: TC: A (0±30PPM/°C) CASE SIZE F**

Cap. pF	Cap. Tol.	WVDC	Cap. pF	Cap. Tol.	WVDC	Cap. pF	Cap. Tol.	WVDC	Cap. pF	Cap. Tol.	WVDC
0.1	A, B	250	2.4	A, B, C	250	18	F, G, J	250	150	F, G, J	250
0.2	A, B	250	2.7	A, B, C	250	20	F, G, J	250	180	F, G, J	250
0.3	A, B	250	3.0	A, B, C	250	22	F, G, J	250	200	F, G, J	250
0.4	A, B	250	3.3	A, B, C	250	24	F, G, J	250	220	F, G, J	250
0.5	A, B, C	250	3.6	A, B, C	250	27	F, G, J	250	240	F, G, J	250
0.6	A, B, C	250	3.9	A, B, C	250	30	F, G, J	250			
0.7	A, B, C	250	4.3	A, B, C	250	33	F, G, J	250			
0.8	A, B, C	250	4.7	A, B, C	250	36	F, G, J	250			
0.9	A, B, C	250	5.1	A, B, C	250	39	F, G, J	250			
1.0	A, B, C	250	5.6	A, B, C	250	43	F, G, J	250			
1.1	A, B, C	250	6.2	A, B, C	250	47	F, G, J	250			
1.2	A, B, C	250	6.8	B, C, D	250	51	F, G, J	250			
1.3	A, B, C	250	7.5	B, C, D	250	56	F, G, J	250			
1.4	A, B, C	250	8.2	B, C, D	250	62	F, G, J	250			
1.5	A, B, C	250	9.1	B, C, D	250	68	F, G, J	250			
1.6	A, B, C	250	10	F, G, J	250	75	F, G, J	250			
1.7	A, B, C	250	11	F, G, J	250	82	F, G, J	250			
1.8	A, B, C	250	12	F, G, J	250	91	F, G, J	250			
1.9	A, B, C	250	13	F, G, J	250	100	F, G, J	250			
2.0	A, B, C	250	15	F, G, J	250	110	F, G, J	250			
2.2	A, B, C	250	16	F, G, J	250	120	F, G, J	250			

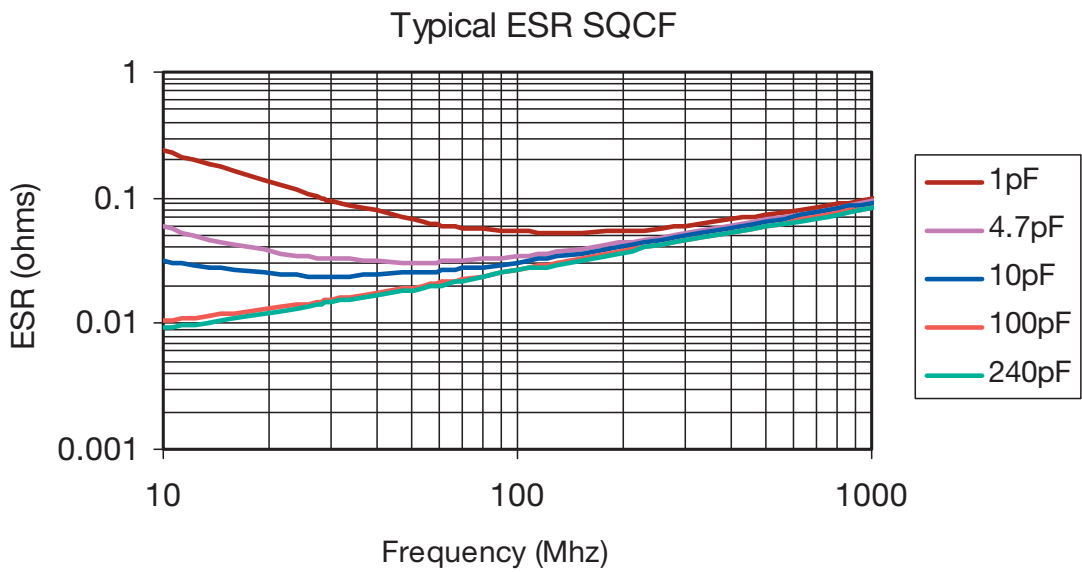
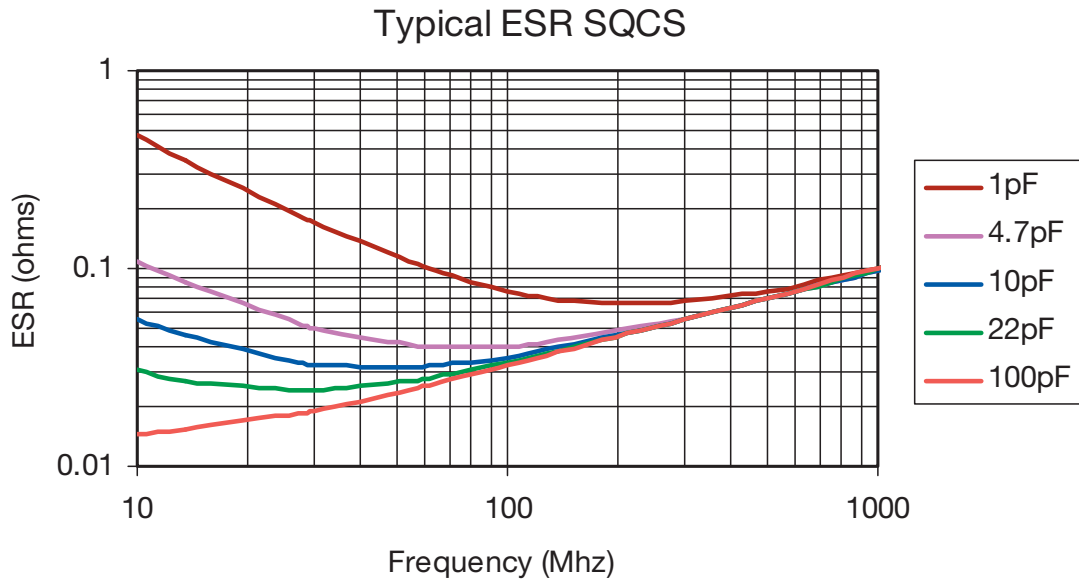

6

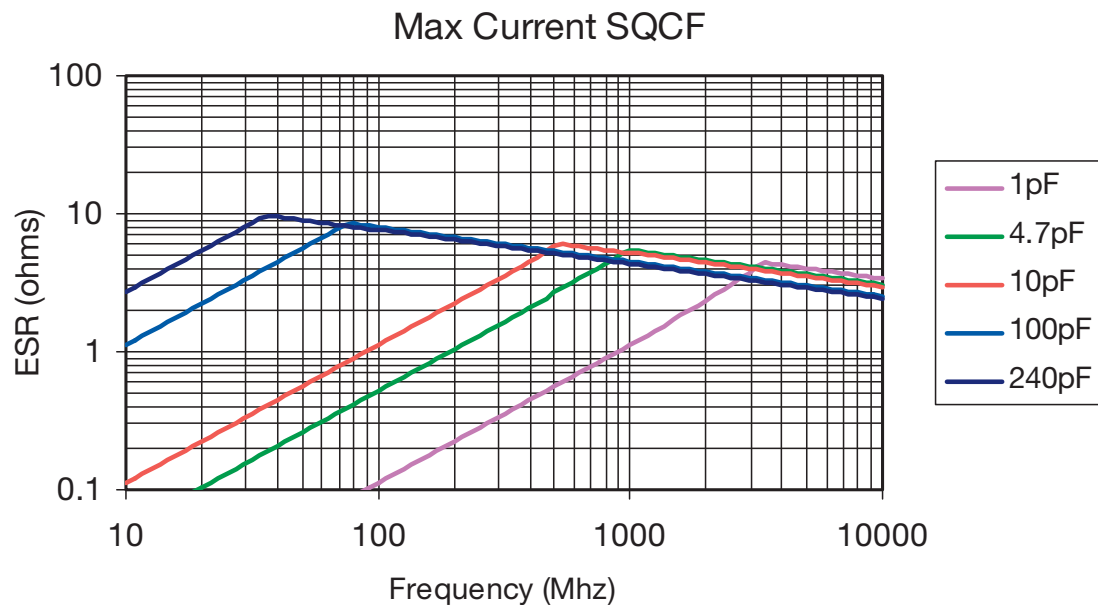
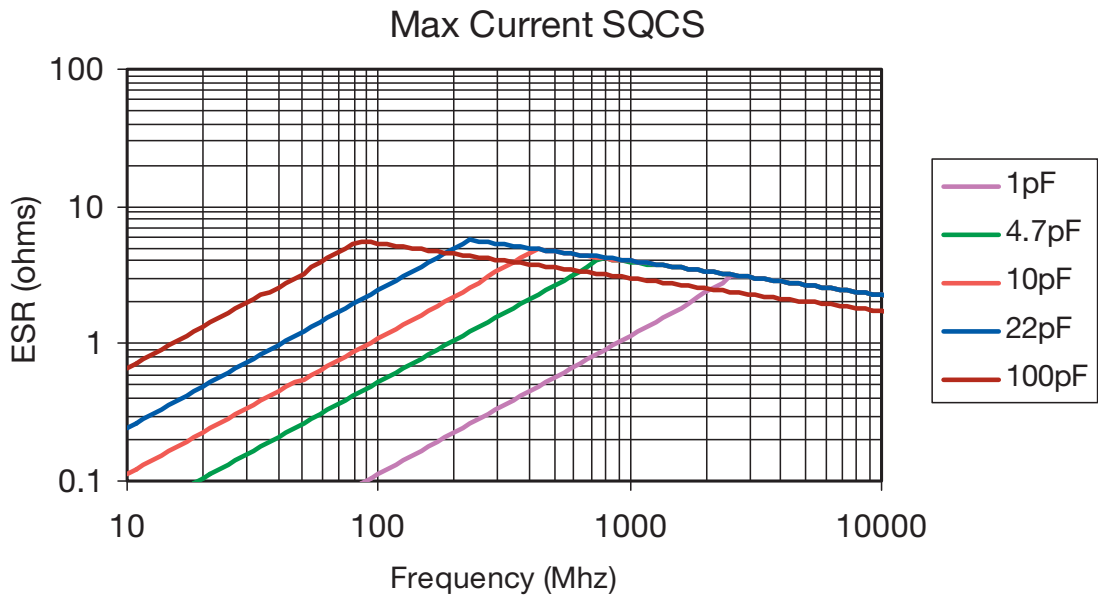

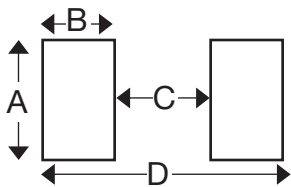
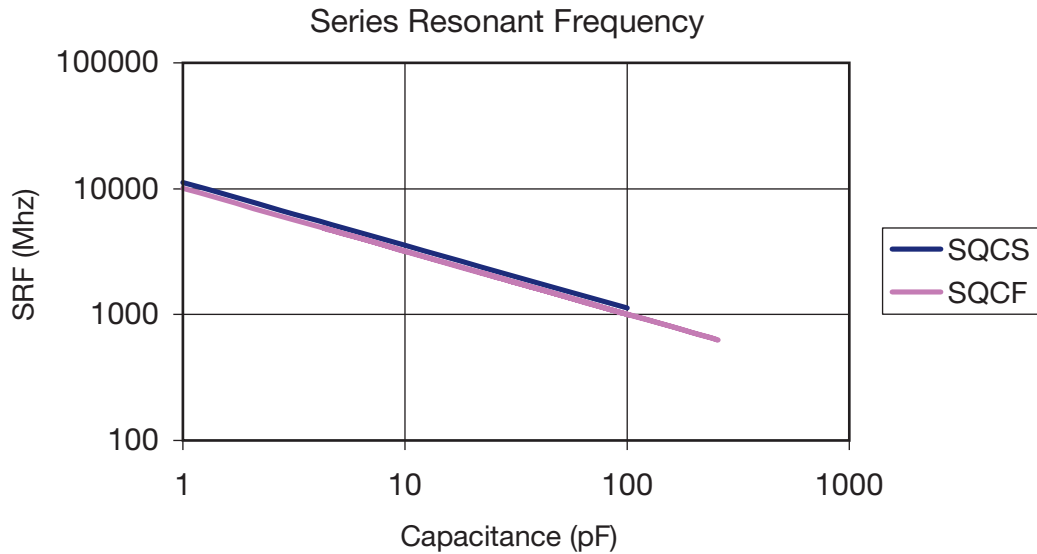

### MOUNTING PAD DIMENSIONS: inches (millimeters)

Case	A min	B min	C min	D min
SQCA	0.082 (2.083)	0.051 (1.295)	0.032 (0.813)	0.130 (3.302)
SQCB	0.131 (3.327)	0.051 (1.295)	0.074 (1.880)	0.177 (4.496)
SQCS	0.038 (0.965)	0.043 (1.092)	0.025 (0.635)	0.112 (2.845)
SQCF	0.059 (1.499)	0.051 (1.295)	0.024 (0.610)	0.125 (3.175)

### SQCS & SQCF ENGINEERING KITS

PN	Series	Diel	Term	Range	Different Values	# per value
Kit SQ018 T	SQCF	C0G	100% Tin RoHS	.1 to 22pF	32	20
Kit SQ019 T				10 to 240pF	23	
Kit SQ015 T	SQCS	C0G	100% Tin RoHS	.1 to 22pF	32	20
Kit SQ016 T				10 to 100pF	16	

Tolerance per PF:	
B from .1 to 3.3	J from 10 to 240
C from 3.9 to 8.2	

# Microwave MLC's

## Automatic Insertion Packaging



**TAPE & REEL:** All tape and reel specifications are in compliance with EIA RS481 (equivalent to IEC 286 part 3).

Sizes SQCA through SQCB, CDR11/12 through 13/14.

- 8mm carrier
- 7" reel:  $\leq 0.040$ " thickness = 2000 pcs  
 $\leq 0.075$ " thickness = 2000 pcs
- 13" reel:  $\leq 0.075$ " thickness = 10,000 pcs

"U" Series - 402/0603/0805/1210 Size Chips

- 8mm carrier
- 7" reel: 0402 = 10,000 pcs  
 0603 & 0805  $\leq 0.40$ " thickness = 4000 pcs  
 0805 . 0.040" thickness & 1210 = 2000 pcs
- 13" reel:  $\leq 0.075$ " thickness = 10,000 pcs

### REEL DIMENSIONS: millimeters (inches)

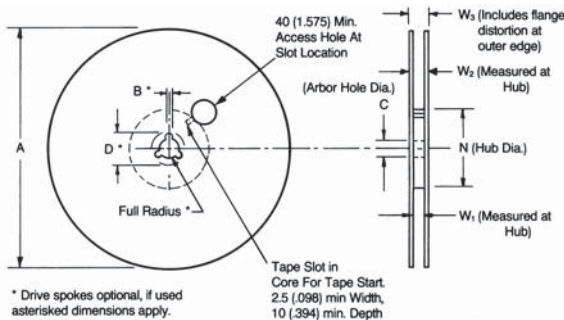

Tape Size <sup>(1)</sup>	A Max.	B* Min.	C	D* Min.	N Min.	W <sub>1</sub>	W <sub>2</sub> Max.	W <sub>3</sub>
8mm	330 (12.992)	1.5 (.059)	13.0±0.20 (.512±.008)	20.2 (.795)	50 (1.969)	8.4 <sup>+1.0</sup> / <sub>-0.0</sub> (.331 <sup>+0.060</sup> / <sub>-0.0</sub> )	14.4 (.567)	7.9 Min. (.311) 10.9 Max. (.429)
12mm						12.4 <sup>+2.0</sup> / <sub>-0.0</sub> (.488 <sup>+0.075</sup> / <sub>-0.0</sub> )	18.4 (.724)	11.9 Min. (.469) 15.4 Max. (.607)

Metric dimensions will govern.  
 English measurements rounded and for reference only.  
 (1) For tape sizes 16mm and 24mm (used with chip size 3640) consult EIA RS-481 latest revision.

### EMBOSSED CARRIER CONFIGURATION

#### 8 & 12 MM TAPE ONLY

#### CONSTANT DIMENSIONS

Tape Size	D <sub>0</sub>	E	P <sub>0</sub>	P <sub>2</sub>	T Max.	T <sub>1</sub>	G <sub>1</sub>	G <sub>2</sub>
8mm and 12mm	8.4 <sup>+0.10</sup> / <sub>-0.0</sub> (.059 <sup>+0.004</sup> / <sub>-0.0</sub> )	1.75 ± 0.10 (.069 ± .004)	4.0 ± 0.10 (.157 ± .004)	2.0 ± 0.05 (.079 ± .002)	0.600 (.024)	0.10 Max. (.004)	0.75 Min. (.030)	0.75 Min. (.030)

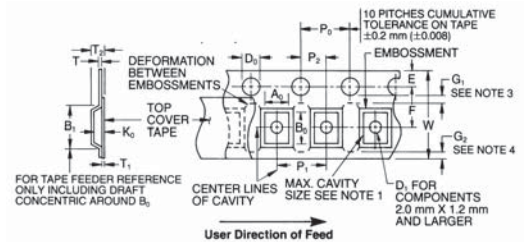

#### VARIABLE DIMENSIONS

Tape Size	B <sub>1</sub> Max. See Note 6	D <sub>1</sub> Min. See Note 5	F	P <sub>1</sub>	R Min. See Note 2	T <sub>2</sub>	W	A <sub>0</sub> B <sub>0</sub> K <sub>0</sub>
8mm	4.55 (.179)	1.0 (.039)	3.5 ± 0.05 (.138 ± .002)	4.0 ± 0.10 (.157 ± .004)	25 (.984)	2.5 Max (.098)	8.0 <sup>+0.3</sup> / <sub>-0.1</sub> (.315 <sup>+0.012</sup> / <sub>-0.004</sub> )	See Note 1
12mm	8.2 (.323)	1.5 (.059)	5.5 ± 0.05 (.217 ± .002)	4.0 ± 0.10 (.157 ± .004)	30 (1.181)	6.5 Max (.256)	12.0 ± .30 (.472 ± .012)	See Note 1

#### NOTES:

- A<sub>0</sub>, B<sub>0</sub>, and K<sub>0</sub> are determined by the max. dimensions to the ends of the terminals extending from the component body and/or the body dimensions of the component. The clearance between the end of the terminals or body of the component to the sides and depth of the cavity (A<sub>0</sub>, B<sub>0</sub>, and K<sub>0</sub>) must be within 0.05 mm (.002) min. and 0.50 mm (.020) max. The clearance allowed must also prevent rotation of the component within the cavity of not more than 20 degrees (see sketches C & D).
- Tape with components shall pass around radius "R" without damage. The minimum trailer length (Note 2 Fig. 3) may require additional length to provide R min. for 12mm embossed tape for reels with hub diameters approaching N min. (Table 4).
- G<sub>1</sub> dimension is the flat area from the edge of the sprocket hole to either the outward deformation of the carrier tape between the embossed cavities or to the edge of the cavity whichever is less.
- G<sub>2</sub> dimension is the flat area from the edge of the carrier tape opposite the sprocket holes to either the outward deformation of the carrier tape between the embossed cavity or to the edge of the cavity whichever is less.
- The embossment hole location shall be measured from the sprocket hole controlling the location of the embossment. Dimensions of embossment location and hole location shall be applied independent of each other.
- B<sub>1</sub> dimension is a reference dimension for tape feeder clearance only.

