

# High Frequency Ceramic Solutions

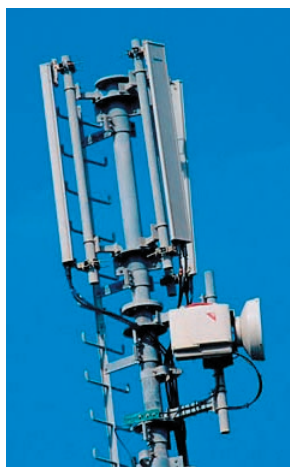
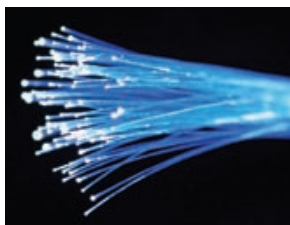

Antennas

Baluns

Capacitors - Low Loss

Couplers

Combiners

Diplexers

Filters - Notch, BP, LP

Inductors

IPC's (Integrated Passive Components)

Modules

90 Hybrids

Substrates

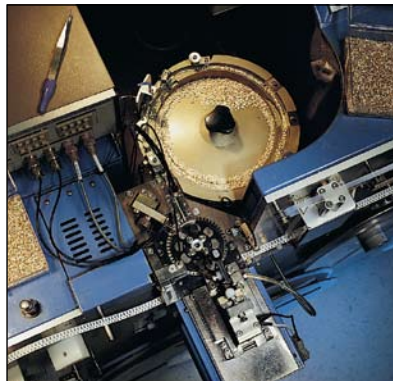
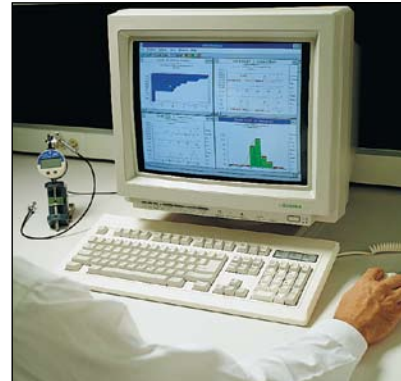

# Your Technology Partner

The mission of the Johanson companies is to translate our customer needs into quality electronic components, produced in factories that are models of excellence, supported by innovative service. With over 20 years of experience, Johanson Technology can provide both standard and custom technology solutions tailored to your specific RF/Microwave applications. Our software design tools, library of more than 20 dielectric materials and various metal systems, and our thin-film and thick-film manufacturing capabilities enable us to produce components that are ideally suited to your specific needs.



Johanson Technology's ISO 9001 Certified design and manufacturing operations are located in Camarillo, California. Our quality minded management system utilizes the latest in computerized SPC systems and continuous improvement programs focused on increased product reliability, manufacturing through-put, and production yields. Our broad experience, applications support, software libraries, and responsive service enhance our ability to drive down your total cost of procurement and speed your time to market.

## CONTENTS

---

Prototyping Kits . . . . .	4-6
JTISoft® Capacitor & Inductor Modeling Software . . . . .	6
Multi-Layer High-Q Capacitors . . . . .	7-15
Monolithic Ceramic Chip Inductors . . . . .	16-20
Wire Wound Ceramic Chip Inductors . . . . .	21-27
Integrated Passive Component Overview . . . . .	28
Antennas . . . . .	29
Band Pass Filters . . . . .	30-32
High Pass Filters . . . . .	32
EMI Filters . . . . .	32
Low Pass Filters . . . . .	33
Directional Couplers . . . . .	34
Baluns & Balun Filters . . . . .	35-36
Diplexers . . . . .	36
Integrated Passive Component Case Size Drawings . . . . .	37
Custom LTCC Modules . . . . .	38
LASERtrim® RF Tuning Capacitors . . . . .	39-42
Broadband Single Layer Capacitors . . . . .	43-44
Single Layer Microwave Capacitors . . . . .	45-50
Custom Thin Film Capabilities . . . . .	51-52
Application Notes . . . . .	53-55
Chip Tape & Reel Packaging . . . . .	56
Inductor Packaging . . . . .	57

Additional application notes may be found on our web site.

*Johanson Technology, Inc. reserves the right to make design and price changes without notice. All sales are subject to the terms and conditions printed on the back side of our sales order acknowledgment forms including a limited warranty and remedies for non-conforming goods or defective goods. We will be pleased to provide a copy of these terms and conditions for your review.*

# RF Ceramic Component Proto-Typing Kits



Johanson Technology's engineering prototype kits provide RF designers with a broad selection of high frequency ceramic components. Each kit contains a selection of components as well as the latest product data on Johanson's full line of "High Frequency Ceramic Solutions". List price is \$100.00 each, but price may be waived for qualified high volume applications. *The selections listed below represents typical kit contents. Johanson reserves the right to make limited value/tolerance substitutions when necessary. Please advise any critical values at time of order.*

## Capacitor and Inductor Design Kits

<b>0201 L-Series Capacitors &amp; Ceramic Inductors</b> (Values {pF or nH} & tolerances) 50 PCS. EA. MLCC (pF): 0.3 B, 0.5 B, 0.7 B, 0.9 B, 1.0 B, 1.2 B, 1.5 B, 1.8 B, 2.2 B, 2.7 B, 3.0 B, 3.3 B, 3.6 B, 3.9 B, 4.3 B, 4.7 B, 5.1 C, 5.6 C, 6.8 C, 8.2 C, 9.1 C, 10 J, 12 J, 15 J, 18 J, 22 J, 27 J, 33 J 50 PCS. EA. MLCI (nH): 0.8 C, 1.0 S, 1.2 S, 1.5 S, 1.8 S, 2.2 S, 2.7 S, 3.3 S, 3.9 S, 4.7 S, 5.6 S, 6.8 J, 8.2 J, 10 J, 12 J, 15 J, 18 J, 20 J, 22 J, 27 J, 33 J	P/N : L/C-201DL
<b>0402 S-Series Capacitors &amp; Ceramic Inductors</b> (Values {pF or nH} & tolerances) 50 PCS. EA. MLCC (pF): 0.2 B, 0.3 B, 0.5 B, 0.7 B, 0.9 B, 1.0 B, 1.2 B, 1.5 B, 1.8 B, 2.0 B, 2.2 B, 2.4 B, 2.7 B, 3.0 B, 3.6 B, 4.3 B, 4.7 B, 5.6 C, 6.8 C, 7.5 C, 8.2 C, 9.1 C, 10 J, 12 J, 15 J, 22 J, 27 J, 30 J 50 PCS. EA. MLCI (nH): 1.0 S, 1.5 S, 1.8 S, 2.2 S, 2.7 S, 3.3 S, 3.9 S, 4.7 S, 5.6 S, 6.8 J, 8.2 J, 10 J, 12 J, 15 J, 18 J, 22 J, 27 J, 33 J, 39 J, 47 J	P/N : L/C-402DS
<b>0603 S-Series Capacitors &amp; Ceramic Inductors</b> (Values {pF or nH} & tolerances) 50 PCS. EA. MLCC (pF): 0.3 B, 0.5 B, 0.8 B, 1.0 B, 1.2 B, 1.5 B, 1.8 B, 2.2 C, 2.7 C, 3.3 C, 3.6 C, 3.9 C, 4.7 C, 5.6 C, 6.8 C, 8.2 C, 10 J, 12 J, 15 J, 18 J, 20 J, 24 J, 27 J, 33 J, 39 J, 47 J, 68 J, 82 J 50 PCS. EA. MLCI (nH): 1.0 S, 1.5 S, 1.8 S, 2.2 S, 2.7 S, 3.3 S, 4.7 S, 5.6 S, 6.8 J, 8.2 J, 10 J, 15 J, 18 J, 27 J, 39 J, 47 J, 68 J, 100 J, 150 J, 220 J	P/N : L/C-603DS
<b>0805 S-Series Capacitors &amp; Ceramic Inductors</b> (Values {pF or nH} & tolerances) 50 PCS. EA. MLCC (pF): 4.7 B, 5.6 C, 6.8 C, 7.5 C, 8.2 C, 9.1 C, 10 J, 12 J, 15 J, 18 J, 20 J, 22 J, 24 J, 27 J, 30 J, 33 J, 36 J, 39 J, 43 J, 47 J, 56 J, 68 J, 82 J, 100 J, 120 J, 150 J, 180 J, 220 J 50 PCS. EA. MLCI (nH): 1.5 S, 1.8 S, 2.2 S, 2.7 S, 3.3 S, 3.9 S, 4.7 S, 5.6 S, 6.8 J, 8.2 J, 10 J, 22 J, 33 J, 47 J, 82 J, 100 J, 150 J, 220 J, 330 J, 470 J	P/N : L/C-805DS
<b>1111 E-Series Capacitors &amp; 0805 Ceramic Inductors</b> (Values {pF or nH} & tolerances) 20 PCS. EA. MLCC (pF): 3.9 B, 4.7 B, 6.8 C, 7.5 C, 8.2 C, 9.1 C, 10 J, 12 J, 15 J, 18 J, 20 J, 27 J, 33 J, 47 J, 56 J, 68 J, 82 J, 100 J, 120 J, 150 J, 180 J, 220 K, 270 K, 330 K, 390 K, 470 K, 560 K, 1000 K 50 PCS. EA. MLCI (nH): 1.5 S, 1.8 S, 2.2 S, 2.7 S, 3.3S, 3.9S, 4.7 S, 5.6 S, 6.8 J, 8.2 J, 10 J, 22 J, 33 J, 47 J, 82 J, 100 J, 150 J, 220 J, 330 J, 470 J	P/N : L/C-111DE

## Tuning Capacitor Kits

<b>0402 S-Series Capacitors</b> (Values {pF} & tolerances) 50 PCS. EACH (pF): 0.2 A, 0.3 A, 0.4 A, 0.5 B, 0.6 B, 0.7 B, 0.8 B, 0.9 B, 1.0 B, 1.1 B, 1.2 B, 1.3 B, 1.5 B, 1.8 B, 2.0 B, 2.2 B, 2.4 B, 2.7 B, 3.0 B, 3.3 B, 3.6 B, 3.9 B, 4.3 B, 4.7 B, 5.1 C, 5.6 C, 6.2 C, 6.8 C	P/N: S402TS
<b>0603 S-Series Capacitors</b> (Values {pF} & tolerances) 50 PCS. EACH (pF): 0.2 B, 0.3 B, 0.4 B, 0.5 B, 0.6 B, 0.7 B, 0.8 B, 0.9 B, 1.0 B, 1.1 B, 1.2 B, 1.3 B, 1.5 B, 1.8 B, 2.0 B, 2.2 B, 2.4 B, 2.7 B, 3.0 B, 3.3 B, 3.6 B, 3.9 C, 4.3 B, 4.7 B, 5.1 C, 5.6 C, 6.2 C, 6.8 C	P/N: S603TS
<b>0805 S-Series Capacitors</b> (Values {pF} & tolerances) 50 PCS. EACH (pF): 0.3 B, 0.5 B, 0.7 B, 0.9 B, 1.0 B, 1.1 B, 1.2 B, 1.3 B, 1.5 B, 1.8 B, 2.0 B, 2.2 B, 2.4 B, 2.7 B, 3.0 B, 3.3 B, 3.6 B, 3.9 B, 4.3 B, 4.7 B, 5.1 C, 5.6 C, 6.2 C, 6.8 C, 7.5 C, 8.2 C, 9.1 C, 10 J	P/N: S805TS
<b>1111 E-Series Capacitors</b> (Values {pF} & tolerances) 20 PCS. EACH (pF): 0.5 B, 0.6 B, 0.7 B, 0.8 B, 0.9 B, 1.0 B, 1.1 B, 1.2 B, 1.3 B, 1.5 B, 2.0 B, 2.2 B, 2.4 B, 2.7 B, 3.0 B, 3.3 B, 3.6 B, 3.9 B, 4.3 B, 4.7 B, 5.1 C, 5.6 C, 6.2 C, 6.8 C, 7.5 C, 8.2 C, 9.1 C, 10 J	P/N: S111TE

## WireWound Inductor Kits

### 0402 WireWound High Q Chip Inductors (Values {nH} & tolerances)

P/N: S402W

20 PCS. EACH (nH): 1.0 C, 1.8 C, 2.0 C, 2.7 C, 3.3 C, 3.9 C, 4.7 C, 5.6 C, 6.8 J, 7.5 J, 8.2 J, 9.0 J, 10 J, 12 J, 15 J, 18 J, 20 J, 22 J, 24 J, 27 J, 30 J, 33 J, 39 J, 47 J, 56 J, 82 J, 100 J, 120 J

### 0603 WireWound High Q Chip Inductors (Values {nH} & tolerances)

P/N: S603W

10 PCS. EACH (nH): 1.6 C, 1.8 C, 2.0 C, 3.9 C, 4.7 C, 5.1 C, 5.6 C, 6.8 J, 7.5 J, 8.2 J, 10 J, 12 J, 15 J, 18 J, 22 J, 27 J, 33 J, 39 J, 47 J, 56 J, 68 J, 72 J, 82 J, 100 J, 150 J, 180 J, 270 J, 330 J

## Single Layer Capacitor Kits

### Broadband Single Layer Capacitors

P/N: GBBL

10 PCS. EACH: V01A151MT, V02A471MT, V02A102MT, V03A102MT, V04A182MT

## (Individual) Capacitor, Inductor Designer Kits

### 0201 L-Series Capacitors (Values {pF} & tolerances)

P/N: S201DL

20 PCS. EACH (pF): 0.3 B, 0.5 B, 0.7 B, 0.9 B, 1.0 B, 1.2 B, 1.5 B, 1.8 B, 2.2 B, 2.7 B, 3.0 B, 3.3 B, 3.6 B, 3.9 B, 4.3 B, 4.7 B, 5.1 C, 5.6 C, 6.8 C, 8.2 C, 9.1 C, 10 J, 12 J, 15 J, 18 J, 22 J, 27 J, 33 J

### 0201 Inductors (Values {nH} & tolerances)

P/N: L201DC

20 PCS. EACH (nH): 0.8 C, 1.0 S, 1.2 S, 1.5 S, 1.8 S, 2.2 S, 2.7 S, 3.3 S, 3.9 S, 4.7 S, 5.6 S, 6.8 J, 8.2 J, 10 J, 12 J, 15 J, 18 J, 20 J, 22 J, 27 J, 33 J

### 0402 S-Series Capacitors (Values {pF} & tolerances)

P/N: S402DS

20 PCS. EACH (pF): 0.2 B, 0.3 B, 0.5 B, 0.7 B, 0.9 B, 1.0 B, 1.2 B, 1.5 B, 1.8 B, 2.0 B, 2.2 B, 2.4 B, 2.7 B, 3.0 B, 3.6 B, 4.3 B, 4.7 B, 5.6 C, 6.8 C, 7.5 C, 8.2 C, 9.1 C, 10 J, 12 J, 15 J, 22 J, 27 J, 30 J

### 0402 Inductors (Values {nH} & tolerances)

P/N: L402DC

20 PCS. EACH (nH): 1.0 S, 1.5 S, 1.8 S, 2.2 S, 2.7 S, 3.3 S, 3.9 S, 4.7 S, 5.6 S, 6.8 J, 8.2 J, 10 J, 12 J, 15 J, 18 J, 22 J, 27 J, 33 J, 39 J, 47 J

### 0603 S-Series Capacitors (Values {pF} & tolerances)

P/N: S603DS

20 PCS. EACH (pF): 0.3 B, 0.5 B, 0.8 B, 1.0 B, 1.2 B, 1.5 B, 1.8 B, 2.2 B, 2.7 B, 3.3 B, 3.6 B, 3.9 B, 4.7 B, 5.6 C, 6.8 C, 8.2 C, 10 J, 12 J, 15 J, 18 J, 20 J, 24 J, 27 J, 33 J, 39 J, 47 J, 68 J, 82 J

### 0603 Inductors (Values {nH} & tolerances)

P/N: L603DC

20 PCS. EACH (nH): 1.0 S, 1.5 S, 1.8 S, 2.2 S, 2.7 S, 3.3 S, 4.7 S, 5.6 S, 6.8 J, 8.2 J, 10 J, 15 J, 18 J, 27 J, 39 J, 47 J, 68 J, 100 J, 150 J, 220 J

### 0805 S-Series Capacitors (Values {pF} & tolerances)

P/N: S805DS

20 PCS. EACH (pF): 4.7 B, 5.6 C, 6.8 C, 7.5 C, 8.2 C, 9.1 C, 10 J, 12 J, 15 J, 18 J, 20 J, 22 J, 24 J, 27 J, 30 J, 33 J, 36 J, 39 J, 43 J, 47 J, 56 J, 68 J, 82 J, 100 K, 120 K, 150 K, 180 K, 220 K

### 0805 Inductors (Values {nH} & tolerances)

P/N: L805DC

20 PCS. EACH (nH): 1.5 S, 1.8 S, 2.2 S, 2.7 S, 3.3 S, 3.9 S, 4.7 S, 5.6 S, 6.8 J, 8.2 J, 10 J, 22 J, 33 J, 47 J, 82 J, 100 J, 150 J, 220 J, 330 J, 470 J

### 1111 E-Series Capacitors (Values {pF} & tolerances)

P/N: S111DE

20 PCS. EACH (pF): 3.9 B, 4.7 B, 6.8 C, 7.5 C, 8.2 C, 9.1 C, 10 J, 12 J, 15 J, 18 J, 20 J, 27 J, 33 J, 47 J, 56 J, 68 J, 82 J, 100 K, 120 K, 150 K, 180 K, 220 K, 270 K, 330 K, 390 K, 470 K, 560 K, 1000 K

## 2.45Ghz Designer Kit for WLAN, Bluetooth, ISM and 802.11

### 0402 S-Series Capacitors, 0402 Inductors & 2.45 GHz RF Components

P/N: 2450L/C402D

6 PCS. EA. BAND PASS FILTERS: 2450BP15B100, 2450BP18C100B, 2450BP18C100D, 2450BP39C100C, 2450BP41D100B  
 6 PCS. EA. CHIP ANTENNA: 2450AT18A100, 2450AT42A100, 2450AT45A100      6 PCS. EA. LOW PASS FILTER 2450LP14A100, 2450LP14B100, 2450LP15A050  
 6 PCS. EA. BALUN: 2450BL14B050, 2450BL14B100, 2450BL15B050, 2450BL15B100, 2450BL15K050, 2450BL15K100  
 6 PCS. EA. DIPLEXER: 2450DP15A5512, 2450DP15D5400  
 50 PCS. EA. MLCC (pF): 0.3 B, 0.5 B, 1.0 B, 1.5 B, 1.8 B, 2.2 B, 2.7 B, 3.3 B, 3.9 B, 4.7 B, 5.6 C, 6.8 C, 8.2 C, 10 J  
 50 PCS. EA. MLCI (nH): 1.0 S, 1.5 S, 1.8 S, 2.2 S, 2.7 S, 3.3 S, 4.7 S, 5.6 S, 6.8 J, 8.2 J, 10 J, 15 J, 18 J, 27 J, 39 J

### 0603 S-Series Capacitors, 0603 Inductors & 2.45 GHz RF Components

P/N: 2450L/C603D

6 PCS. EA. BAND PASS FILTERS: 2450BP15B100, 2450BP18C100B, 2450BP18C100D, 2450BP39C100C, 2450BP41D100B  
 6 PCS. EA. CHIP ANTENNA: 2450AT18A100, 2450AT42A100, 2450AT45A100      6 PCS. EA. LOW PASS FILTER 2450LP14A100, 2450LP14B100, 2450LP15A050  
 6 PCS. EA. BALUN: 2450BL14B050, 2450BL14B100, 2450BL15B050, 2450BL15B100, 2450BL15K050, 2450BL15K100  
 6 PCS. EA. DIPLEXER: 2450DP15A5512, 2450DP15D5400  
 50 PCS. EA. MLCC (pF): 0.3 B, 0.5 B, 1.0 B, 1.5 B, 1.8 B, 2.2 C, 2.7 C, 3.3 C, 3.9 C, 4.7 C, 5.6 C, 6.8 C, 8.2 C, 10 J  
 50 P CS. EA. MLCI (nH): 1.0 S, 1.5 S, 1.8 S, 2.2 S, 2.7 S, 3.3 S, 4.7 S, 5.6 S, 6.8 J, 8.2 J, 10 J, 15 J, 18 J, 27 J, 39 J

## 5.5Ghz Designer Kit for WLAN, Bluetooth, ISM and 802.11

### 0402 S-Series Capacitors, 0402 Inductors & RF Components

P/N: 5500L/C402D

6 PCS. EA. BAND PASS FILTERS: 5515BP15C1020, 5515BP15B725, 5515BP15B730, 5515BP15C975, 5487BP15B675, 5487BP15C675  
 6 PCS. EA. CHIP ANTENNA: 2450AD46A5400, 5250AT43A200, 5400AT18A1000, 5775AT43A100      6 PCS. EA. LOW PASS FILTER 5515LP15A730  
 6 PCS. EA. BALUN: 5400BL15B050, 5400BL15B100, 5400BL15K050, 5512BL15B100, 5800BL15B100  
 6 PCS. EA. DIPLEXER: 2450DP15A5512, 2450DP15B5512, 2450DP15D5400, 2450DP15E5400  
 50 PCS. EA. MLCC (pF): 0.3 B, 0.5 B, 0.8 B, 1.0 B, 1.2 B, 1.5 B, 1.8 B, 2.0 B, 2.2 B, 2.7 B, 3.3 B, 3.9 B, 4.7 B, 5.6 C  
 50 PCS. EA. MLCI (nH): 1.0 S, 1.5 S, 1.8 S, 2.2 S, 2.7 S, 3.3 S, 3.9 S, 4.7 S, 5.6 S, 6.8 J, 8.2 J, 10 J, 12 J, 15 J, 18 J

### 0603 S-Series Capacitors, 0603 Inductors & RF Components

P/N: 5500L/C603D

6 PCS. EA. BAND PASS FILTERS: 5515BP15C1020, 5515BP15B725, 5515BP15B730, 5515BP15C975, 5487BP15B675, 5487BP15C675  
 6 PCS. EA. CHIP ANTENNA: 2450AD46A5400, 5250AT43A200, 5400AT18A1000, 5775AT43A100      6 PCS. EA. LOW PASS FILTER 5515LP15A730  
 6 PCS. EA. BALUN: 5400BL15B050, 5400BL15B100, 5400BL15K050, 5512BL15B100, 5800BL15B100  
 6 PCS. EA. DIPLEXER: 2450DP15A5512, 2450DP15B5512, 2450DP15D5400, 2450DP15E5400  
 50 PCS. EA. MLCC (pF): 0.3 B, 0.5 B, 0.8 B, 1.0 B, 1.2 B, 1.5 B, 1.8 B, 2.0 B, 2.2 B, 2.7 B, 3.3 B, 3.9 B, 4.7 B, 5.6 C  
 50 PCS. EA. MLCI (nH): 1.0 S, 1.5 S, 1.8 S, 2.2 S, 2.7 S, 3.3 S, 3.9 S, 4.7 S, 5.6 S, 6.8 J, 8.2 J, 10 J, 12 J, 15 J, 18 J

# JTIsoft® CAPACITOR & INDUCTOR MODELING SOFTWARE

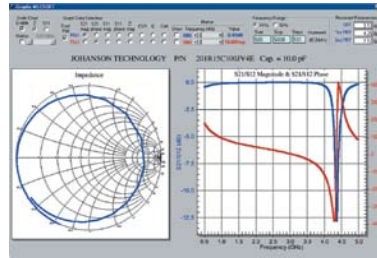
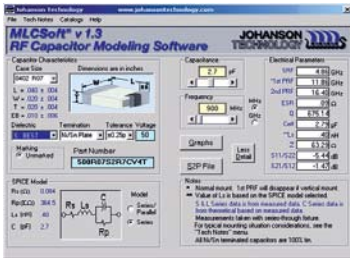

#	mHz	s	ma	r	50
500	0.21	-71.9	0.95	18.1	0.95
545	0.29	-72.1	0.96	16.7	0.96
590	0.37	-74.3	0.96	15.6	0.96
635	0.25	-75.2	0.97	14.6	0.97
680	0.24	-76.1	0.97	13.7	0.97
725	0.22	-76.8	0.97	12.9	0.97
770	0.21	-77.5	0.98	12.3	0.98
815	0.20	-78.1	0.98	11.6	0.98
860	0.19	-78.7	0.98	11.1	0.98
905	0.18	-79.1	0.98	10.6	0.98
950	0.18	-79.6	0.98	10.1	0.98
995	0.17	-80.0	0.98	9.7	0.98
1040	0.16	-80.3	0.99	9.3	0.99
1085	0.16	-80.7	0.99	9.0	0.99

JTIsoft® consists of two advanced design simulation software programs which offer component modeling from 1 MHz to 20 GHz. MLCsoft® provides S-Parameter and SPICE modeling data for six different size high frequency multi-layer ceramic capacitors (MLCCs) chip sizes while MLIsoft® provides S-Parameter and SPICE modeling on four different size high frequency multi-layer ceramic inductors (MLCIs). The main interface screen displays electrical parameters such as SRF, PRF1, PRF2, ESR, Q, Ceff, Leff, Rdc, and Idc which are updated dynamically as chip size, value, and frequency parameters are varied by the user. The complete part number is also dynamically displayed for ordering accuracy.

Both programs also provide highly detailed graphical plots of device performance over a user specified frequency range. The chart displays are instantly updated as the user makes component or frequency changes. Smith chart displays of both impedance and S11/S22 are available as point plots, line plots, and line-point plots. Traditional X-Y graphs are available for parameters of S21 and S11 both phase and magnitude, Impedance magnitude, as well as Q, ESR and effective capacitance. Display formats include standard, log Y, and log/log. Chart may be exported in BMP or Metafile format. Numerical S-Parameter data may be displayed and exported as an .S2P format file.

JTIsoft® is available for download from our web site.

# MULTI-LAYER HIGH-Q CAPACITORS

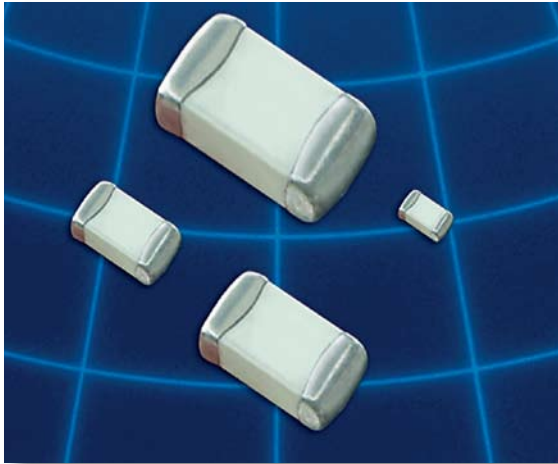

These lines of multilayer capacitors have been developed for High-Q and microwave applications.

- The **S-Series** (R03S, R07S, R14S, R15S) capacitors give an ultra-high Q performance, and exhibit NPO temperature characteristics.
- The **L-Series** (R05L) capacitors give mid-high Q performance, and exhibit NPO temperature characteristics.
- The **E-Series** (S42E, S48E, S58E) capacitors give excellent high-Q performance from HF to Microwave frequencies. Typical uses are high voltage, high current applications. They are offered in chip (Ni barrier or Non-Magnetic Pt.-Ag) or in Non-Magnetic leaded form.
- The **W-Series** (R05W) capacitors offer a large capacitance value in an ultra-small 0201 package size. These exhibit a X7R temperature characteristic.
- RoHS compliance is standard for all unleaded parts (see termination options box).

## HOW TO ORDER

<b>252</b>	<b>S48</b>	<b>E</b>	<b>470</b>	<b>K</b>	<b>Y</b>	<b>4</b>	<b>E</b>
<b>VOLTAGE</b> 6.3 = 6R3 V 160 = 16 V 250 = 25 V 500 = 50 V 251 = 250 V 501 = 500 V 102 = 1000 V 152 = 1500 V 202 = 2000 V 252 = 2500 V 362 = 3600 V	<b>CASE SIZE</b> R03 (01005) R05 (0201) R07 (0402) R14 (0603) R15 (0805) S42 (1111) S48 (2525) S58 (3838)	<b>CAPACITANCE</b> 1st two digits are significant; third digit denotes number of zeros, R = decimal. 100 = 10 pF 101 = 100 pF	<b>DIELECTRIC</b> <b>E</b> = NPO, High Q, High Power <b>L</b> = NPO <b>S</b> = S Dielectric <b>W</b> = X7R	<b>TOLERANCE</b> ** A = +/- 0.05 pF * B = ± 0.10 pF * C = ± 0.25 pF * D = ± 0.50 pF F = ±1 % G = ±2% J = ±5% K = +/- 10%  For tolerance availability, see chart.	<b>TERMINATION</b> <b>Nickel Barrier Types</b> G = Ni/Au T = Ni/Sn-Pb V = Ni / 100% Sn <b>Non Magnetic Types</b> Y = Non-Leaded Pt-Ag 1 = Microstrip Ribbon Leads (E-Series Only) 2 = Axial Ribbon Leads (E-Series Only)	<b>MARKING</b> 3 = Cap Code & Tolerance 4 = No Marking 6 = EIA Code (Marking on 0805 and larger only)	<b>PACKAGING</b> S = Bulk W = Waffle Pack  <b>01005 - 0603</b> Y = Paper 5" Reel T = Paper 7" Reel  <b>0805 - 3838</b> Z = Embossed 5" Reel E = Embossed 7" Reel U = Embossed 13" Reel  Tape specifications conform to EIA RS481

Part Number written: **252S48E470KY4E**

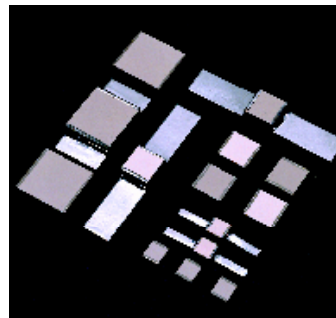

## LOW ESR / HIGH-Q CAPACITOR SELECTION CHART

EIA Size		Miniature Size - Portable Electronics				RF Power Applications							
		01005 (R03S)	0201 (R05)		0402 (R07S)	0603 (R14S)	0805 (R15S)	1111 (S42E)	2525 (S48E)	3838 (S58E)			
NPO (R05L)	X7R* (R05W)												
Capacitance pF	Code	Tolerance	Voltage										
0.1	0R1	A							500V	1000V			
0.2	0R2		16 V	25 V		50 V	250 V		500V	1000V			
0.3	0R3		16 V	25 V		50 V	250 V	250 V	500V	1000V			
0.4	0R4		16 V	25 V		50 V	250 V	250 V	500V	1000V			
0.5	0R5		16 V	25 V		50 V	250 V	250 V	500V	1000V			
0.6	0R6		16 V	25 V		50 V	250 V	250 V	500V	1000V			
0.7	0R7		16 V	25 V		50 V	250 V	250 V	500V	1000V			
0.8	0R8		16 V	25 V		50 V	250 V	250 V	500V	1000V			
0.9	0R9		16 V	25 V		50 V	250 V	250 V	500V	1000V			
1.0	1R0		16 V	25 V		50 V	250 V	250 V	500V	1000V	2500V	3600V	7200V
1.1	1R1		16 V	25 V		50 V	250 V	250 V	500V	1000V			
1.2	1R2		16 V	25 V		50 V	250 V	250 V	500V	1000V	2500V	3600V	7200V
1.3	1R3		16 V	25 V		50 V	250 V	250 V	500V	1000V			
1.4	1R4		16 V	25 V		50 V	250 V	250 V	500V	1000V			
1.5	1R5		16 V	25 V		50 V	250 V	250 V	500V	1000V	2500V	3600V	7200V
1.6	1R6		16 V	25 V		50 V	250 V	250 V	500V	1000V			
1.7	1R7		16 V	25 V		50 V	250 V	250 V	500V	1000V			
1.8	1R8		16 V	25 V		50 V	250 V	250 V	500V	1000V	2500V	3600V	7200V
1.9	1R9		16 V	25 V		50 V	250 V	250 V	500V	1000V			
2.0	2R0	16 V	25 V		50 V	250 V	250 V	500V	1000V				
2.1	2R1	16 V	25 V		50 V	250 V	250 V	500V	1000V				
2.2	2R2	16 V	25 V		50 V	250 V	250 V	500V	1000V	2500V	3600V	7200V	
2.4	2R4	16 V	25 V		50 V	250 V	250 V	500V	1000V				
2.7	2R7	16 V	25 V		50 V	250 V	250 V	500V	1000V	2500V	3600V	7200V	
3.0	3R0	16 V	25 V		50 V	250 V	250 V	500V	1000V				
3.3	3R3	16 V	25 V		50 V	250 V	250 V	500V	1000V	2500V	3600V	7200V	
3.6	3R6	16 V	25 V		50 V	250 V	250 V	500V	1000V				
3.9	3R9	16 V	25 V		50 V	250 V	250 V	500V	1000V	2500V	3600V	7200V	
4.3	4R3	16 V	25 V		50 V	250 V	250 V	500V	1000V				
4.7	4R7	16 V	25 V		50 V	250 V	250 V	500V	1000V	2500V	3600V	7200V	
5.1	5R1	16 V	25 V		50 V	250 V	250 V	500V	1000V				
5.6	5R6	16 V	25 V		50 V	250 V	250 V	500V	1000V	2500V	3600V	7200V	
6.2	6R2	16 V	25 V		50 V	250 V	250 V	500V	1000V				
6.8	6R8	16 V	25 V		50 V	250 V	250 V	500V	1000V	2500V	3600V	7200V	
7.5	7R5	16 V	25 V		50 V	250 V	250 V	500V	1000V				
8.2	8R2	16 V	25 V		50 V	250 V	250 V	500V	1000V				
9.1	9R1	16 V	25 V		50 V	250 V	250 V	500V	1000V				
10	100	16 V	25 V		50 V	250 V	250 V	500V	1000V	2500V	3600V	7200V	
11	110		25 V		50 V	250 V	250 V						
12	120		25 V		50 V	250 V	250 V	500V	1000V	2500V	3600V	7200V	
13	130		25 V		50 V	250 V	250 V	500V	1000V				
15	150		25 V		50 V	250 V	250 V	500V	1000V	2500V	3600V	7200V	
16	160		25 V		50 V	250 V	250 V	500V	1000V				
18	180		25 V		50 V	250 V	250 V	500V	1000V	2500V	3600V	7200V	
20	200		25 V		50 V	250 V	250 V	500V	1000V				
22	220		25 V		50 V	250 V	250 V	500V	1000V	2500V	3600V	7200V	
24	240		25 V		50 V	250 V	250 V	500V	1000V				
27	270		25 V		50 V	250 V	250 V	500V	1000V	2500V	3600V	7200V	
30	300		25 V		25 V	250 V	250 V	500V	1000V				
33	330		25 V		25 V	250 V	250 V	500V	1000V	2500V	3600V	7200V	

\* The R05W parts, which are X7R, can only be provided with "K" tolerance.  
Consult factory for Non-Standard values.



## LOW ESR / HIGH-Q CAPACITOR SELECTION CHART

EIA Size Cap. Value		Miniature Size - Portable Electronics				RF Power Applications							
		01005 (R03S)	0201 (R05) NPO (R05L)	X7R* (R05W)	0402 (R07S)	0603 (R14S)	0805 (R15S)	1111 (S42E)	2525 (S48E)	3838 (S58E)			
Capacitance pF	Code	Voltage											
36	360		25 V			250 V	250 V	500V	1000V				
39	390		25 V			250 V	250 V	500V	1000V	2500V	3600V	7200V	
43	430		25 V			250 V	250 V	500V	1000V				
47	470		25 V			250 V	250 V	500V	1000V	2500V	3600V	7200V	
51	510		25 V			250 V	250 V	500V	1000V				
56	560		25 V			250 V	250 V	500V	1000V	2500V	3600V	7200V	
62	620		25 V			250 V	250 V	500V	1000V				
68	680		25 V			250 V	250 V	500V	1000V	2500V	3600V	7200V	
75	750		25 V			250 V	250 V	500V	1000V				
82	820	F	25 V			250 V	250 V	500V	1000V	2500V	3600V	7200V	
91	910	G	25 V			250 V	250 V	500V	1000V				
100	101	J	25 V			250 V	250 V	500V	1000V	2500V	3600V	7200V	
110	111	K		16 V			250 V	300V					
120	121						250 V	300V		2500V	3600V	5000V	
130	131						250 V	300V					
150	151						250 V	300V		2500V	3600V	5000V	
160	161						250 V	300V					
180	181						250 V	300V		2500V	3600V	5000V	
200	201						250 V	300V					
220	221			16 V			250 V	200V		2500V	3600V		
240	241							200V					
270	271							200V		2500V	3600V		
300	301							200V					
330	331							200V		1500V	3600V		
360	361							200V					
390	391							200V		1500V	3600V		
430	431							200V					
470	471			16 V				200V		1500V	2500V		
510	511							100V					
560	561							100V		1000V	2500V		
620	621							100V					
680	681			16 V				50V		1000V	2500V		
750	751							50V					
820	821			16 V				50V		1000V	1000V		
910	911							50V					
1000	102	K		10 V				50V		1000V	1000V		
1200	122									1000V	1000V		
1500	152									500V	1000V		
1800	182									500V	1000V		
2200	222			10 V						300V	1000V		
2700	272									300V	500V		
3300	332										500V		
3900	392										500V		
4700	472			10 V							500V		
5100	512										500V		
10000	103			6.3 V									

\* The R05W parts, which are X7R, can only be provided with "K" tolerance.  
Consult factory for Non-Standard values.

## DIELECTRIC CHARACTERISTICS

## NPO

## X7R

TEMPERATURE COEFFICIENT:	0 ± 30ppm /°C, -55 to 125°C	± 15%, -55 to 125°C
QUALITY FACTOR / DF:	Q >1,000 @ 1 MHz, Typical 10,000	16VDC DF ≤ 3.5% @ 1 KHz, 25°C 10VDC DF ≤ 5.0% @ 1 KHz, 25°C
INSULATION RESISTANCE:	>10 GΩ @ 25°C, WVDC; 125°C IR is 10% of 25°C rating	>500 ΩF* or 10 GΩ* @ 25°C, WVDC; 125°C IR is 10% of 25°C rating * whichever is less
DIELECTRIC STRENGTH:	2.5 X WVDC Min., 25°C, 50 mA max	2.5 X WVDC Min., 25°C, 50 mA max
TEST PARAMETERS:	1MHz ±50kHz, 1.0±0.2 VRMS, 25°C	1KHz ±50Hz, 1.0±0.2 VRMS, 25°C
AVAILABLE CAPACITANCE:	Size 01005: 0.2 - 10 pF Size 0201: 0.2 - 100 pF Size 0402: 0.2 - 33 pF Size 0603: 0.2 - 100 pF Size 0805: 0.3 - 220 pF Size 1111: 0.1 - 1000 pF Size 2525: 1.0 - 2700 pF Size 3838: 1.0 - 5100 pF	100 - 10,000 pF

## MECHANICAL & ENVIRONMENTAL CHARACTERISTICS

	SPECIFICATION	TEST PARAMETERS
SOLDERABILITY:	Solder coverage ≥ 90% of metalized areas No termination degradation	Preheat chip to 120°-150°C for 60 sec., dip terminals in rosin flux then dip in Sn62 solder @ 240°±5°C for 5±1 sec
RESISTANCE TO SOLDERING HEAT:	No mechanical damage Capacitance change: ±2.5% or 0.25pF Q>500 I.R. >10 G Ohms Breakdown voltage: 2.5 x WVDC	Preheat device to 80°-100°C for 60 sec. followed by 150°-180°C for 60 sec. Dip in 260°±5°C solder for 10±1 sec. Measure after 24±2 hour cooling period
TERMINAL ADHESION:	Termination should not pull off. Ceramic should remain undamaged.	Linear pull force* exerted on axial leads soldered to each terminal. *0402 ≥ 2.0lbs, 0603 ≥ 2.0lbs (min.)
PCB DEFLECTION:	No mechanical damage. Capacitance change: 2% or 0.5pF Max	Glass epoxy PCB: 0.5 mm deflection
LIFE TEST:	No mechanical damage Capacitance change: ±3.0% or 0.3 pF Q>500 I.R. >1 G Ohms Breakdown voltage: 2.5 x WVDC	Applied voltage: 200% rated voltage, 50 mA max. Temperature: 125°±3°C Test time: 1000+48-0 hours
THERMAL CYCLE:	No mechanical damage. Capacitance change: ±2.5% or 0.25pF Q>2000 I.R. >10 G Ohms Breakdown voltage: 2.5 x WVDC	5 cycles of: 30±3 minutes @ -55°+0/-3°C, 2-3 min. @ 25°C, 30±3 min. @ +125°+3/-0°C, 2-3 min. @ 25°C Measure after 24±2 hour cooling period
HUMIDITY, STEADY STATE:	No mechanical damage. Capacitance change: ±5.0% or 0.50pF max. Q>300 I.R. ≥ 1 G-Ohm Breakdown voltage: 2.5 x WVDC	Relative humidity: 90-95% Temperature: 40°±2°C Test time: 500 +12/-0 Hours Measure after 24±2 hour cooling period
HUMIDITY, LOW VOLTAGE:	No mechanical damage. Capacitance change: ±5.0% or 0.50pF max. Q>300 I.R. = 1 G-Ohm min. Breakdown voltage: 2.5 x WVDC	Applied voltage: 1.5 VDC, 50 mA max. Relative humidity: 85±2% Temperature: 40°±2°C Test time: 240 +12/-0 Hours Measure after 24±2 hour cooling period
VIBRATION:	No mechanical damage. Capacitance change: ±2.5% or 0.25pF Q>1000 I.R. ≥ 10 G-Ohm Breakdown voltage: 2.5 x WVDC	Cycle performed for 2 hours in each of three perpendicular directions Frequency range 10Hz to 55 Hz to 10 Hz traversed in 1 minute. Harmonic motion amplitude: 1.5mm



## MECHANICAL CHARACTERISTICS

Size	Units	Length	Width	Thickness	End Band
01005	In	.016 ±.001	.008 ±.001	.008 ±.001	.006 Max.
(0402)	mm	(0.40 ±0.03)	(0.20 ±0.03)	(0.20 ±0.03)	(0.15 Max.)
0201	In	.024 ±.001	.012 ±.001	.012 ±.001	.008 Max.
(0603)	mm	(0.60 ±0.03)	(0.30 ±0.03)	(0.30 ±0.03)	(0.20 Max.)
0402	In	.040 ±.004	.020 ±.004	.020 ±.004	.010 ±.006
(1005)	mm	(1.02 ±0.1)	(0.51 ±0.1)	(0.51 ±0.1)	(0.25 ±.15)
0603	In	.062 ±.006	.032 ±.006	.030 +.005/- .003	.014 ±.006
(1608)	mm	(1.57 ±0.15)	(0.81 ±0.15)	(0.76 +.13-.08)	(0.35 ±.15)
0805	In	.080 ±.008	.050 ±.008	.040 ±.006	.020 ±.010
(2012)	mm	(2.03 ±0.20)	(1.27 ±0.20)	(1.02 ±.15)	(0.50 ±.25)

## E-SERIES LEAD STYLE SELECTION

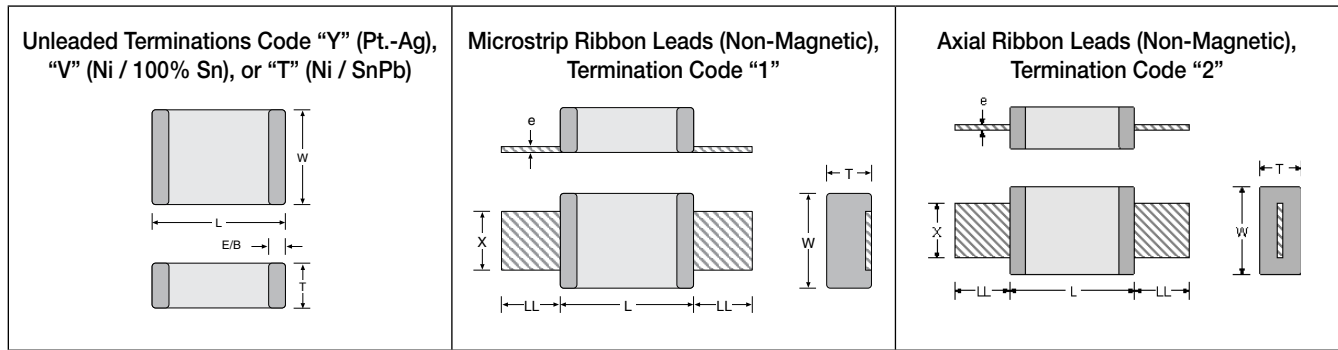

Lead	Size	Units	L	Tol	W	Tol	T	E / B
Y, V, T	S42E	In	0.110	+0.020 -0.010	0.110	+/- .020	0.102 Max.	0.015 Typ.
		mm	2.79	+0.51 -0.25	2.79	+/- 0.51	2.59 Max.	0.38 Typ.
	S48E	In	0.230	+0.025 -0.010	0.250	+/- .015	0.150 Max.	0.025 Typ.
		mm	5.84	+0.63 -0.25	6.35	+/- 0.38	3.81 Max.	0.63 Typ.
	S58E	In	0.380	+0.015 -0.010	0.380	+/- .010	0.170 Max.	0.025 Typ.
		mm	9.65	+0.38 -0.25	9.65	+/- 0.25	4.32 Max.	0.63 Typ.

For all E-Series Models:

**OPERATING TEMP. :**

-55 to +125°C

**INSULATION RESISTANCE:**

>1000 ΩF or 100 GΩ, whichever is less @ 25°C WVDC

**TEMPERATURE COEFFICIENT:**

0 ± 30ppm /°C, -55 to 125°C

**DISSIPATION FACTOR (TYP):**

< 0.05% @ 1 MHz

Lead	Size	Units	L	Tol	W	Tol	T (max)	E/B (typ)	LL(min)	X	Tol	e	Tol
1	S42E	In	0.135	+/- .015	0.110	+/- .020	0.120	0.015	0.25	0.093	+/-0.005	0.004	+/- 0.001
		mm	3.43	+/- 0.38	2.79	+/- 0.51	3.05	0.38	6.35	2.36	+/- 0.13	0.102	+/- 0.025
	S48E	In	0.245	+/- 0.025	0.250	+/- 0.015	0.160	0.025	0.50	0.240	+/- 0.005	0.004	+/- 0.001
		mm	6.22	+/- 0.64	6.35	+/-0.38	3.81	0.63	12.7	6.10	+/- 0.13	0.102	+/- 0.025
	S58E	In	0.38	+0.035 / - 0.010	0.38	+/- 0.010	0.170	0.04 MAX.	0.750	0.35	+/- 0.010	0.010	+/- 0.005
		mm	9.65	+0.89 / -0.25	9.65	+/- 0.25	4.32	1.02 MAX.	19.05	8.89	+/- 0.25	0.25	+/- 0.13
2	S42E	In	0.135	+/- .015	0.110	+/- .020	0.102	0.015	0.25	0.093	+/-0.005	0.004	+/- 0.001
		mm	3.43	+/- 0.38	2.79	+/- 0.51	2.59	0.38	6.35	2.36	+/- 0.13	0.102	+/- 0.025
	S48E	In	0.245	+/- 0.025	0.250	+/- 0.015	0.160	0.025	0.50	0.240	+/- 0.005	0.004	+/- 0.001
		mm	6.22	+/- 0.64	6.35	+/-0.38	3.81	0.63	12.7	6.10	+/- 0.13	0.102	+/- 0.025
	S58E	In	0.38	+0.035 / - 0.010	0.38	+/- 0.010	0.170	0.04 MAX.	0.750	0.35	+/- 0.010	0.010	+/- 0.005
		mm	9.65	+0.89 / -0.25	9.65	+/- 0.25	4.32	1.02 MAX.	19.05	8.89	+/- 0.25	0.25	+/- 0.13

# SERIES RESONANCE CHART

Typical Series Resonant Frequency (Series Mounted)

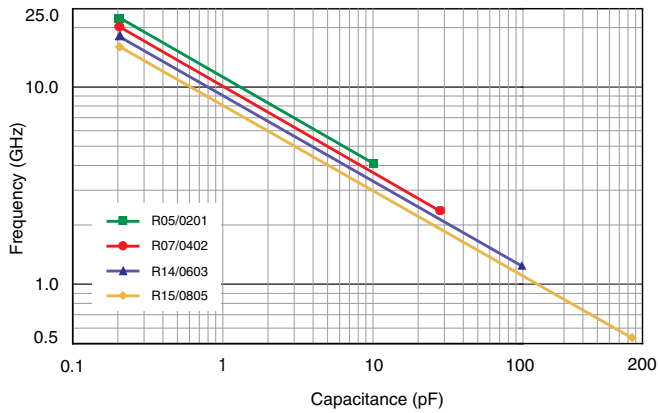

# RF CHARACTERISTICS - L-SERIES

ESR vs Frequency: 0201/R05L

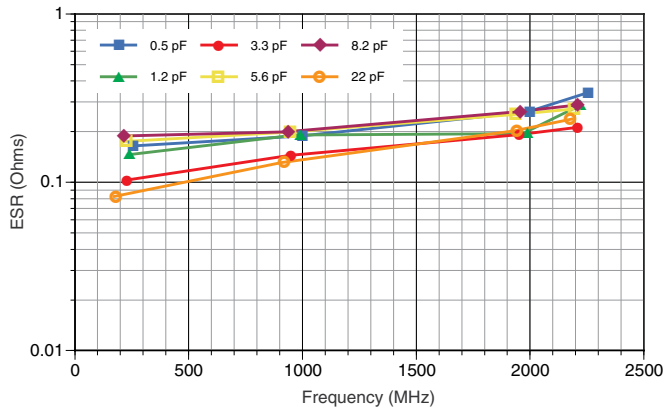

Q vs Frequency: 0201/R05L

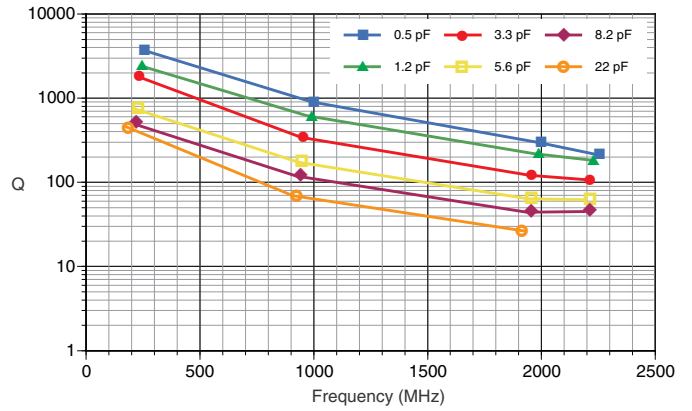

ESR vs Capacitance: 0201/R05L

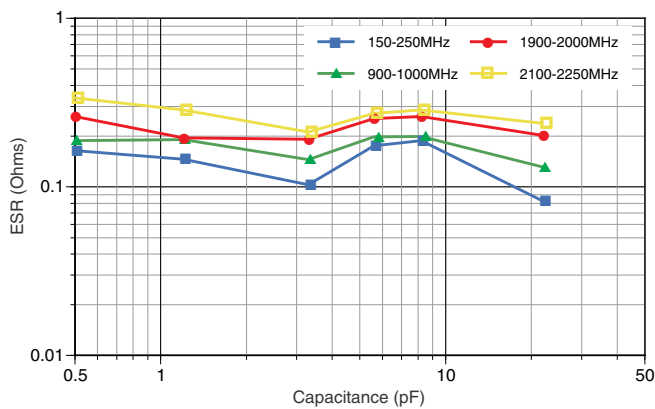

Q vs Capacitance: 0201/R05L

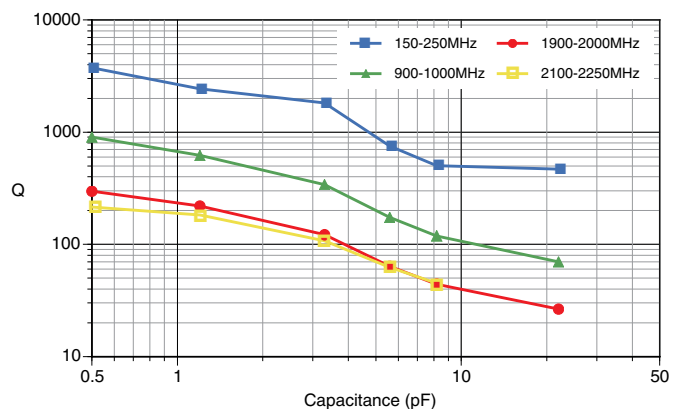

## S-SERIES RF CHARACTERISTICS VERSUS FREQUENCY

Equivalent Series Resistance: 0402/R07S

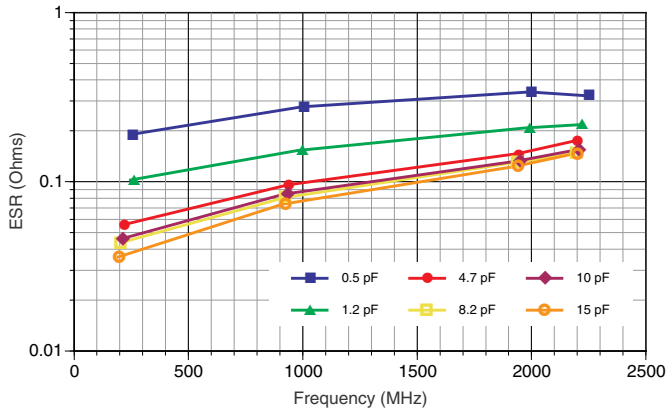

Q Factor: 0402/R07S

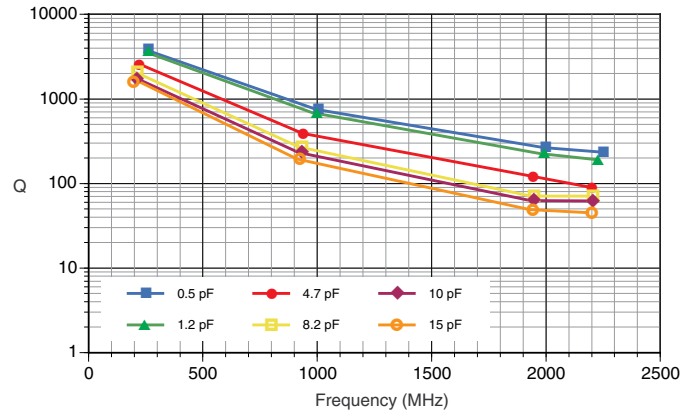

Equivalent Series Resistance: 0603/R14S

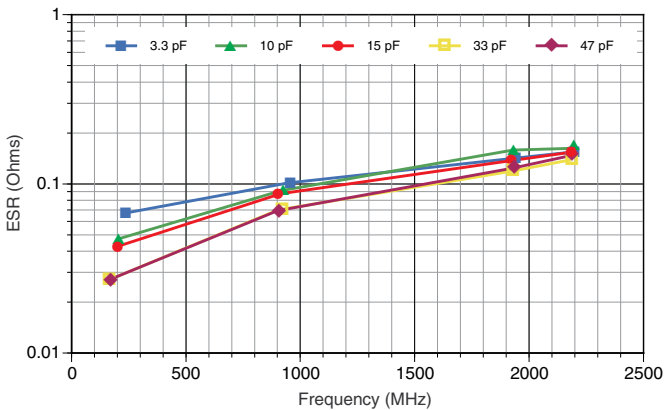

Q Factor: 0603/R14S

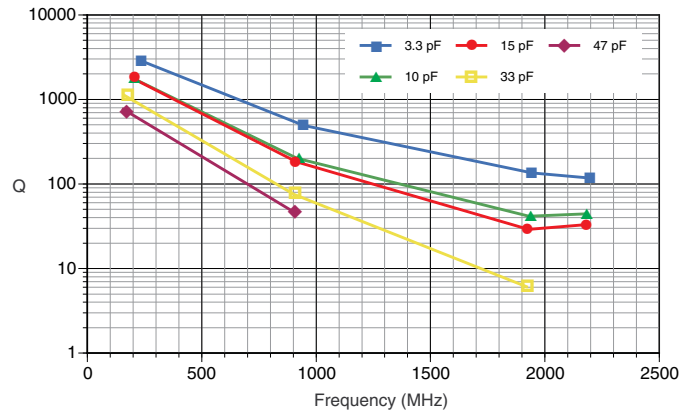

Measurements performed on a Boonton 34A Resonant Coaxial Line and represent typical capacitor performance.

## S-SERIES RF CHARACTERISTICS VERSUS CAPACITANCE

Equivalent Series Resistance: 0603/R14S

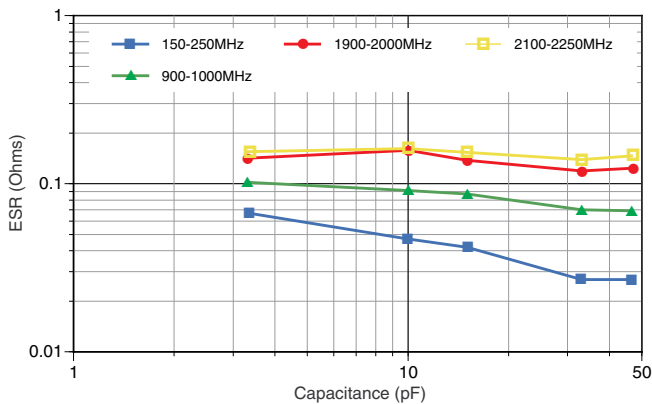

Q Factor: 0603/R14S

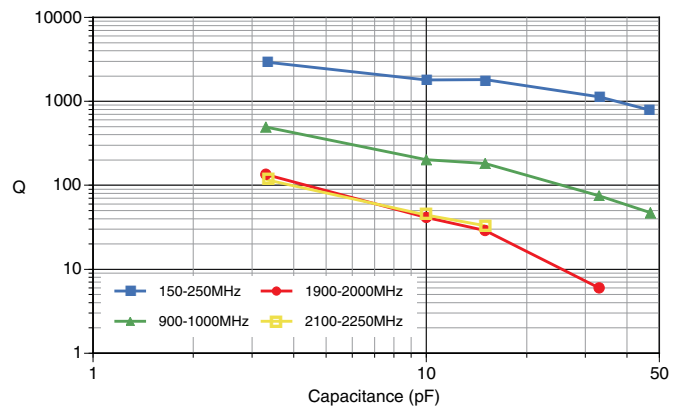

Measurements performed on a Boonton 34A Resonant Coaxial Line and represent typical capacitor performance.

## S-SERIES RF CHARACTERISTICS VERSUS CAPACITANCE

Equivalent Series Resistance: 0402/R07S

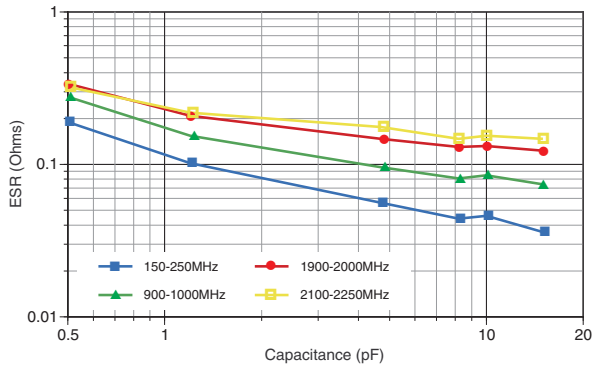

Q Factor: 0402/R07S

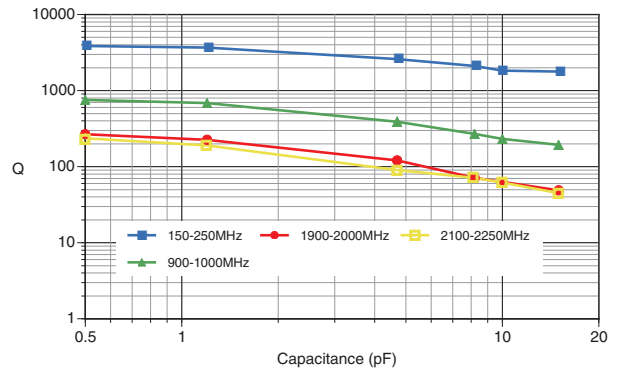

## JTI S42E GRAPHICAL DATA

SRF (Shunt Mount), S42E, Typical

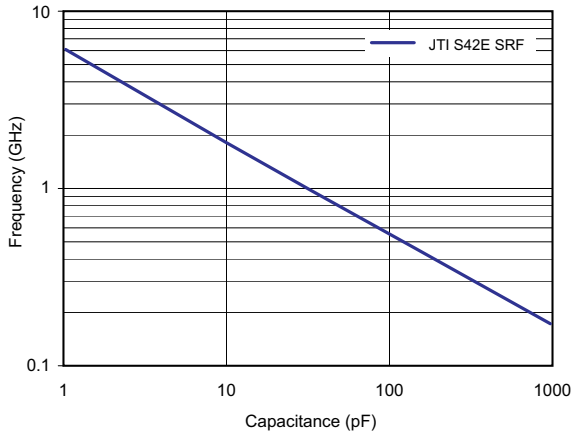

As measured on a 8720C VNA, using a Shunt-Through fixture, and using the S11 magnitude dip to determine the SRF

Current Rating vs. Capacitance, S42E, Typical (Preliminary)

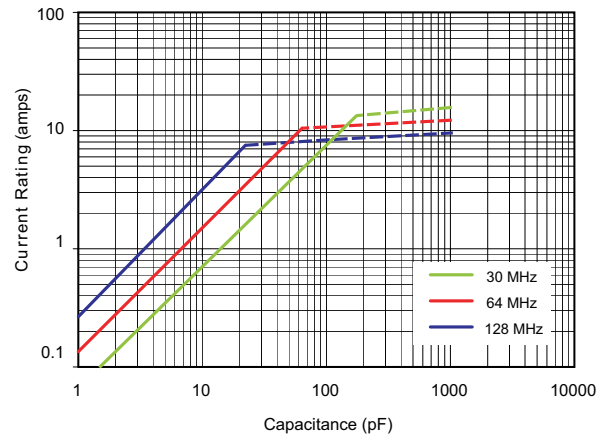

Solid traces show voltage limited current (Vrms)  
Dotted traces show power dissipation limited current (Based on 3 Watts Power Dissipation, and 125 degrees C case temp.)

S42E Q vs. Capacitance, Typical

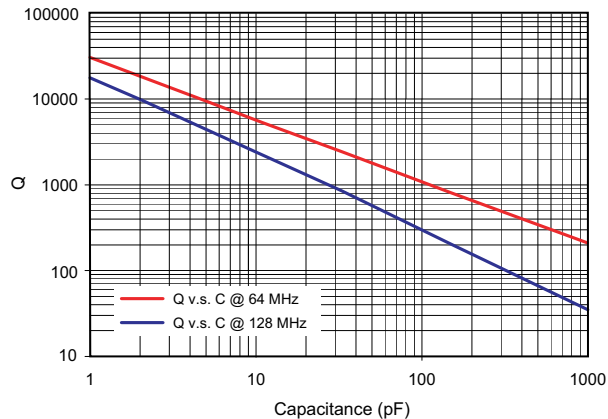

As measured on a 4287A LCR meter, using a 16092A fixture

S42E ESR v.s. Capacitance, Typical

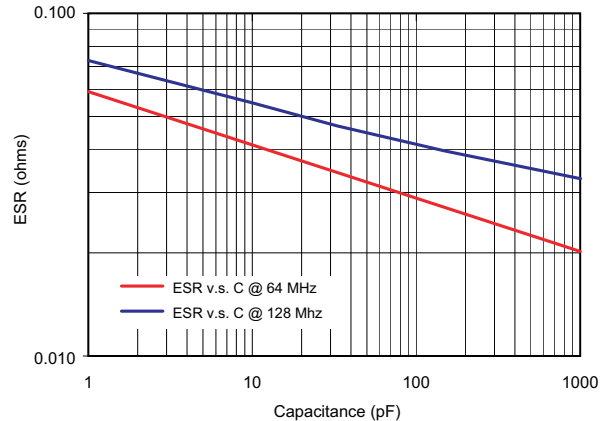

As measured on a 4287A LCR meter, using a 16092A fixture

SRF (Shunt Mount), S48E, Typical (Preliminary)

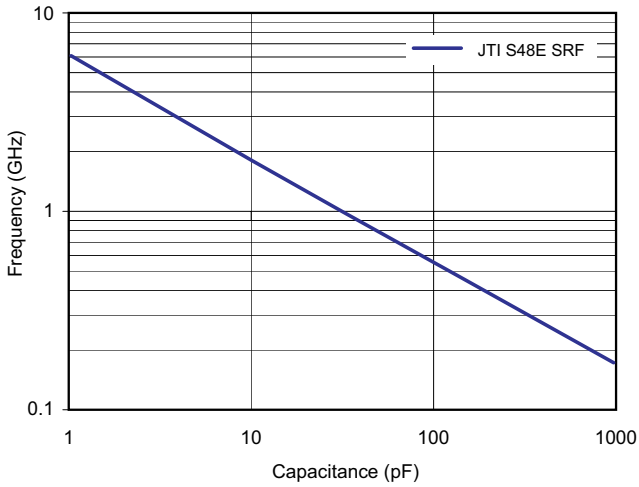

As measured on a 8720C VNA, using a Shunt-Through fixture, and using the S11 magnitude dip to determine the SRF

Current Rating vs. Capacitance, S48E, Typical (Preliminary)

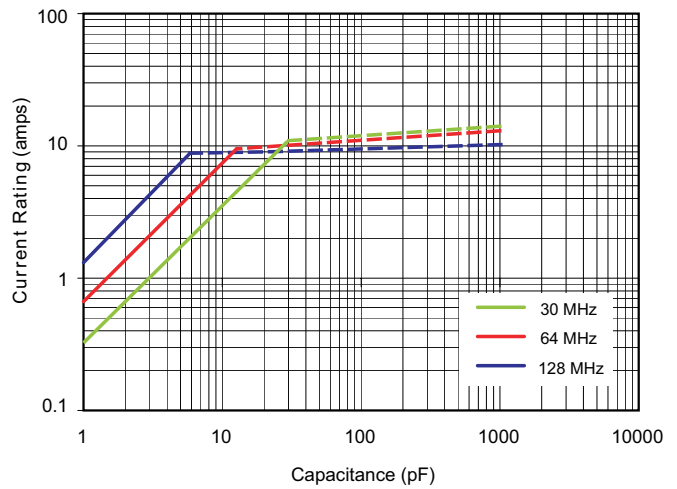

Solid traces show voltage limited current (Vrms)

Dotted traces show power dissipation limited current (Based on 4 Watts Power Dissipation, and 125 degrees C case temp.)

S48E Q vs. Capacitance, Typical (Preliminary)

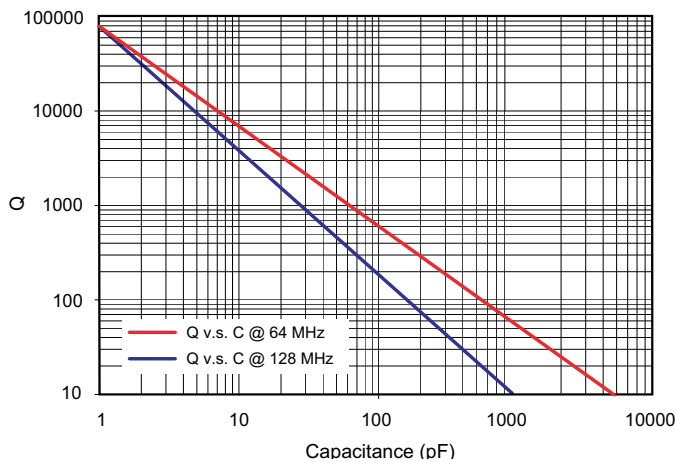

As measured on a 4287A LCR meter, using a 16092A fixture

S48E ESR v.s. Capacitance, Typical (Preliminary)

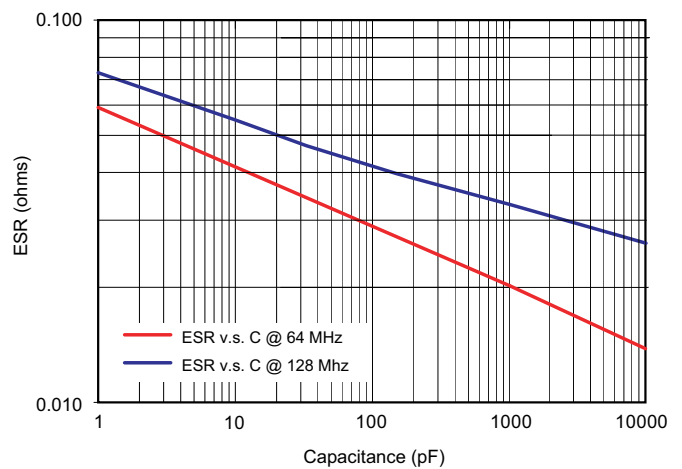

As measured on a 4287A LCR meter, using a 16092A fixture

# RF CERAMIC CHIP INDUCTORS



High frequency multi-layer chip inductors feature a monolithic body made of low loss ceramic and high conductivity metal electrodes to achieve optimal high frequency performance.

These RF chip inductors are compact in size and feature lead-free tin plated nickel barrier terminations and tape and reel packaging which makes them ideal for small size/high volume wireless applications.

## APPLICATIONS & FEATURES

- CELL/PCS Modules
- Broadband Components
- RF Tranceivers
- RoHS Compliant (Standard, "V" Code)
- Sn/Pb Terminations Optional ("T" Code)
- Wireless LAN
- RFID
- 01005 Mini. Size Available

## PRODUCT RANGE SUMMARY

EIA SIZE (mm)	SIZE CODE	L RANGE	Q FACTOR (Min.)	SRF (Typ.)	TEMPERATURE
01005 (0402)	L-03	0.8 - 3.9 nH	2 (100 MHz)	>21 GHz (1.0 nH)	-40°C to + 100°C
0201 (0603)	L-05	0.6 - 39 nH	4 (100 MHz)	>21 GHz (1.0 nH)	-40°C to + 100°C
0402 (1005)	L-07	1.0 - 120 nH	8 (100 MHz)	>21 GHz (1.0 nH)	-40°C to + 100°C
0603 (1608)	L-14	1.0 - 220 nH	12 (100 MHz)	>23 GHz (1.0 nH)	-40°C to + 100°C
0805 (2012)	L-15	1.5 - 680 nH	8 (100 MHz)	>21 GHz (1.5 nH)	-40°C to + 100°C

## MECHANICAL CHARACTERISTICS

	01005 (0402)		0201 (0603)		0402 (1005)		0603 (1608)		0805 (2012)	
	Inches	mm	Inches	mm	Inches	mm	Inches	mm	Inches	mm
Length	.016 ±.001"	(0.4 ± 0.03)	.024 ±.001"	(0.6 ± 0.03)	.039 ±.004"	(1.00 ±.10)	.063 ±.006"	(1.60 ±.15)	.079 ±.008"	(2.00 ±.20)
Width	.008 ±.001"	(0.2 ± 0.03)	.012 ±.001"	(0.3 ± 0.03)	.020 ±.004"	(0.50 ±.10)	.031 ±.006"	(0.80 ±.15)	.047 ±.008"	(1.20 ±.20)
Thickness	.008 ±.001"	(0.2 ± 0.03)	.012 ±.001"	(0.3 ± 0.03)	.020 ±.004"	(0.50 ±.10)	.031 ±.006"	(0.80 ±.15)	.033 ±.008"	(0.85 ±.20)
End Band	.004 ±.002"	(0.1 ± 0.05)	.006 ±.002"	(0.15 ± 0.05)	.009 ±.004"	(0.23 ±.10)	.012 ±.008"	(0.30 ±.20)	.020 ±.012"	(0.50 ±.30)

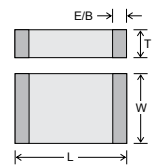

## HOW TO ORDER

DEVICE	SIZE	TYPE	VALUE	TOLERANCE	TERMINATION	MARKING	TAPE & REEL																									
Inductor	05 = 0201 07 = 0402 14 = 0603 15 = 0805	Ceramic	See Table	C = ± 0.2 nH ≤ 1.0 nH S = ± 0.3 nH 1.0 to 5.6 nH J = ± 5% 6.8 nH and above K = ± 10% 3.3 nH and above	V = Ni/Sn T = Ni / SnPb	4 = No Marking 6 = Orientation Mark (0402 Only)	<table border="1"> <thead> <tr> <th>Size</th> <th>Code</th> <th>Tape</th> <th>Reel</th> <th>Qty</th> </tr> </thead> <tbody> <tr> <td>0201</td> <td>T</td> <td>Paper</td> <td>7"</td> <td>15,000</td> </tr> <tr> <td>0402</td> <td>T</td> <td>Paper</td> <td>7"</td> <td>10,000</td> </tr> <tr> <td>0603</td> <td>T</td> <td>Paper</td> <td>7"</td> <td>4,000</td> </tr> <tr> <td>0805</td> <td>E</td> <td>Embossed</td> <td>7"</td> <td>4,000</td> </tr> </tbody> </table>	Size	Code	Tape	Reel	Qty	0201	T	Paper	7"	15,000	0402	T	Paper	7"	10,000	0603	T	Paper	7"	4,000	0805	E	Embossed	7"	4,000
Size	Code	Tape	Reel	Qty																												
0201	T	Paper	7"	15,000																												
0402	T	Paper	7"	10,000																												
0603	T	Paper	7"	4,000																												
0805	E	Embossed	7"	4,000																												

Part number written: L-07C10NJV6T



## 01005 INDUCTANCE RANGE / ELECTRICAL CHARACTERISTICS

Part Number	Inductance @ 100 MHz	Tolerance	Q (Min.) @ 100 MHz	Q (Typ.) @ 100 MHz	Q Typ. @ 900 MHz	Q Typ. @ 1800 MHz	Typical SRF Max	DC Resistance	Rated Current
L-03C0N8SV4T	0.8 nH	+/- 0.3 nH	2	3	10	5	> 13500 MHz		0.20
L-03C1N0SV4T	1.0 nH	+/- 0.3 nH	2	3	10	5	> 13500 MHz	0.20 Ω	200 mA
L-03C1N2SV4T	1.2 nH	+/- 0.3 nH	2	3	10	5	> 13500 MHz	0.22 Ω	200 mA
L-03C1N5SV4T	1.5 nH	+/- 0.3 nH	2	3	10	5	> 13500 MHz	0.24 Ω	200 mA
L-03C1N8SV4T	1.8 nH	+/- 0.3 nH	2	3	10	5	> 13500 MHz	0.30 Ω	200 mA
L-03C2N2SV4T	2.2 nH	+/- 0.3 nH	2	3	10	5	12300	0.44 Ω	200 mA
L-03C2N7SV4T	2.7 nH	+/- 0.3 nH	2	3	10	5	11700	0.50 Ω	200 mA
L-03C3N3SV4T	3.3 nH	± 0.3 nH or ±10%	2	3	10	5	9800	0.55 Ω	200 mA
L-03C3N9SV4T	3.9 nH	± 0.3 nH or ±10%	2	3	10	5	8200	0.60 Ω	200 mA

## 0201 INDUCTANCE RANGE / ELECTRICAL CHARACTERISTICS

Part Number	Inductance	Tolerance	Q (Min.)	L/Q Freq.	Typical SRF	DC Resistance Max	Rated Current
L-05C0N6CV4T	0.6 nH	± 0.2 nH	4	100 MHz	>13000 MHz	0.12 Ω	300 mA
L-05C0N7CV4T	0.7 nH	± 0.2 nH	4	100 MHz	>13000 MHz	0.12 Ω	300 mA
L-05C0N8CV4T	0.8 nH	± 0.2 nH	4	100 MHz	>13000 MHz	0.12 Ω	300 mA
L-05C0N9CV4T	0.9 nH	± 0.2 nH	4	100 MHz	>13000 MHz	0.12 Ω	300 mA
L-05C1N0*V4T	1.0 nH	± 0.2 or ± 0.3 nH	4	100 MHz	>13000 MHz	0.12 Ω	300 mA
L-05C1N2*V4T	1.2 nH	± 0.2 or ± 0.3 nH	4	100 MHz	>13000 MHz	0.15 Ω	300 mA
L-05C1N3*V4T	1.3 nH	± 0.2 or ± 0.3 nH	4	100 MHz	>13000 MHz	0.15 Ω	300 mA
L-05C1N5*V4T	1.5 nH	± 0.2 or ± 0.3 nH	4	100 MHz	>13000 MHz	0.18 Ω	300 mA
L-05C1N8SV4T	1.8 nH	± 0.3 nH	4	100 MHz	10500 MHz	0.22 Ω	300 mA
L-05C2N2SV4T	2.2 nH	± 0.3 nH	4	100 MHz	9500 MHz	0.26 Ω	300 mA
L-05C2N3SV4T	2.3 nH	± 0.3 nH	4	100 MHz	9200 MHz	0.28 Ω	300 mA
L-05C2N4SV4T	2.4 nH	± 0.3 nH	4	100 MHz	9000 MHz	0.30 Ω	300 mA
L-05C2N5SV4T	2.5 nH	± 0.3 nH	4	100 MHz	9000 MHz	0.30 Ω	300 mA
L-05C2N7SV4T	2.7 nH	± 0.3 nH	4	100 MHz	8500 MHz	0.32 Ω	300 mA
L-05C3N0@V4T	3.0 nH	± 0.3 nH ±10%	4	100 MHz	8000 MHz	0.36 Ω	300 mA
L-05C3N3@V4T	3.3 nH	± 0.3 nH ±10%	4	100 MHz	7500 MHz	0.38 Ω	300 mA
L-05C3N6@V4T	3.6 nH	± 0.3 nH ±10%	4	100 MHz	7000 MHz	0.43 Ω	300 mA
L-05C3N7@V4T	3.7 nH	± 0.3 nH ±10%	4	100 MHz	6900 MHz	0.44 Ω	300 mA
L-05C3N9@V4T	3.9 nH	± 0.3 nH ±10%	4	100 MHz	6800 MHz	0.45 Ω	300 mA
L-05C4N7@V4T	4.7 nH	± 0.3 nH ±10%	4	100 MHz	6000 MHz	0.50 Ω	300 mA
L-05C5N1@V4T	5.1 nH	± 0.3 nH ±10%	5	100 MHz	5700 MHz	0.55 Ω	300 mA
L-05C5N6@V4T	5.6 nH	± 0.3 nH ±10%	5	100 MHz	5500 MHz	0.60 Ω	300 mA
L-05C6N8#V4T	6.8 nH	±5% ±10%	5	100 MHz	4800 MHz	0.70 Ω	250 mA
L-05C8N2#V4T	8.2 nH	±5% ±10%	5	100 MHz	4600 MHz	0.90 Ω	250 mA
L-05C10N#V4T	10.0 nH	±5% ±10%	5	100 MHz	4000 MHz	1.20 Ω	250 mA
L-05C12N#V4T	12.0 nH	±5% ±10%	5	100 MHz	3500 MHz	1.30 Ω	250 mA
L-05C13N#V4T	13.0 nH	±5% ±10%	5	100 MHz	3500 MHz	1.35 Ω	250 mA
L-05C15N#V4T	15.0 nH	±5% ±10%	5	100 MHz	3000 MHz	1.40 Ω	250 mA
L-05C18N#V4T	18.0 nH	±5% ±10%	5	100 MHz	2500 MHz	1.50 Ω	200 mA
L-05C22N#V4T	22.0 nH	±5% ±10%	5	100 MHz	2200 MHz	1.80 Ω	200 mA
L-05C27N#V4T	27.0 nH	±5% ±10%	5	100 MHz	1800 MHz	2.00 Ω	200 mA
L-05C33N#V4T	33.0 nH	±5% ±10%	5	100 MHz	1500 MHz	2.30 Ω	200 mA
L-05C39N#V4T	39.0 nH	±5% ±10%	5	100 MHz	1400 MHz	2.50 Ω	200 mA

## 0402 INDUCTANCE RANGE / ELECTRICAL CHARACTERISTICS

Part Number	Inductance	Tolerance	Q (Min.)	L/Q Freq.	Typical SRF	DC Resistance Max	Rated Current
L-07C1N0*V6T	1.0 nH	± 0.2 or 0.3 nH	8	100 MHz	>15000 MHz	0.12 Ω	300 mA
L-07C1N2SV6T	1.2 nH	± 0.3 nH	8	100 MHz	>15000 MHz	0.12 Ω	300 mA
L-07C1N5SV6T	1.5 nH	± 0.3 nH	8	100 MHz	>15000 MHz	0.13 Ω	300 mA
L-07C1N6SV6T	1.6 nH	± 0.3 nH	8	100 MHz	14000 MHz	0.14 Ω	300 mA
L-07C1N8SV6T	1.8 nH	± 0.3 nH	8	100 MHz	14000 MHz	0.14 Ω	300 mA
L-07C1N9SV6T	1.9 nH	± 0.3 nH	8	100 MHz	13000 MHz	0.15 Ω	300 mA
L-07C2N0SV6T	2.0 nH	± 0.3 nH	8	100 MHz	12000 MHz	0.16 Ω	300 mA
L-07C2N2SV6T	2.2 nH	± 0.3 nH	8	100 MHz	12000 MHz	0.16 Ω	300 mA

\* = Choice of C or S Tolerance, @ = S or K Tolerance, # = J or K Tolerance



## 0402 CONTINUED

Part Number	Inductance	Tolerance	Q (Min.)	L/Q Freq.	Typical SRF	DC Resistance Max	Rated Current
L-07C2N4SV6T	2.4 nH	± 0.3 nH	8	100 MHz	10000 MHz	0.16 Ω	300 mA
L-07C2N7SV6T	2.7 nH	± 0.3 nH	8	100 MHz	9500 MHz	0.17 Ω	300 mA
L-07C3N0@V6T	3.0 nH	± 0.3 nH	8	100 MHz	9000 MHz	0.18 Ω	300 mA
L-07C3N3@V6T	3.3 nH	± 0.3 nH ±10%	8	100 MHz	8500 MHz	0.19 Ω	300 mA
L-07C3N6@V6T	3.6 nH	± 0.3 nH ±10%	8	100 MHz	7500 MHz	0.21 Ω	300 mA
L-07C3N9@V6T	3.9 nH	± 0.3 nH ±10%	8	100 MHz	7000 MHz	0.22 Ω	300 mA
L-07C4N3@V6T	4.3 nH	± 0.3 nH ±10%	8	100 MHz	6000 MHz	0.24 Ω	300 mA
L-07C4N7@V6T	4.7 nH	± 0.3 nH ±10%	8	100 MHz	6000 MHz	0.24 Ω	300 mA
L-07C5N1@V6T	5.1 nH	± 0.3 nH ±10%	8	100 MHz	5500 MHz	0.26 Ω	300 mA
L-07C5N6@V6T	5.6 nH	± 0.3 nH ±10%	8	100 MHz	5400 MHz	0.27 Ω	300 mA
L-07C6N2#V6T	6.2 nH	±5% ±10%	8	100 MHz	5200 MHz	0.30 Ω	300 mA
L-07C6N8#V6T	6.8 nH	±5% ±10%	8	100 MHz	5000 MHz	0.32 Ω	250 mA
L-07C7N5#V6T	7.5 nH	±5% ±10%	8	100 MHz	4600 MHz	0.40 Ω	250 mA
L-07C8N2#V6T	8.2 nH	±5% ±10%	8	100 MHz	4600 MHz	0.40 Ω	250 mA
L-07C10N#V6T	10.0 nH	±5% ±10%	8	100 MHz	3700 MHz	0.45 Ω	250 mA
L-07C12N#V6T	12.0 nH	±5% ±10%	8	100 MHz	3200 MHz	0.50 Ω	250 mA
L-07C13N#V6T	13.0 nH	±5% ±10%	8	100 MHz	3100 MHz	0.55 Ω	250 mA
L-07C15N#V6T	15.0 nH	±5% ±10%	8	100 MHz	3100 MHz	0.60 Ω	250 mA
L-07C18N#V6T	18.0 nH	±5% ±10%	8	100 MHz	2900 MHz	0.65 Ω	200 mA
L-07C20N#V6T	20.0 nH	±5% ±10%	8	100 MHz	2100 MHz	0.80 Ω	200 mA
L-07C22N#V6T	22.0 nH	±5% ±10%	8	100 MHz	2100 MHz	0.80 Ω	200 mA
L-07C23N#V6T	23.0 nH	±5% ±10%	8	100 MHz	2100 MHz	0.85 Ω	200 mA
L-07C27N#V6T	27.0 nH	±5% ±10%	8	100 MHz	1900 MHz	0.90 Ω	200 mA
L-07C33N#V6T	33.0 nH	±5% ±10%	8	100 MHz	1600 MHz	1.00 Ω	200 mA
L-07C39N#V6T	39.0 nH	±5% ±10%	8	100 MHz	1400 MHz	1.20 Ω	150 mA
L-07C43N#V6T	43.0 nH	±5% ±10%	8	100 MHz	1300 MHz	1.30 Ω	150 mA
L-07C47N#V6T	47.0 nH	±5% ±10%	8	100 MHz	1200 MHz	1.30 Ω	150 mA
L-07C56N#V6T	56.0 nH	±5% ±10%	8	100 MHz	1100 MHz	2.00 Ω	150 mA
L-07C68N#V6T	68.0 nH	±5% ±10%	8	100 MHz	1000 MHz	2.20 Ω	100 mA
L-07C82N#V6T	82.0 nH	±5% ±10%	8	100 MHz	900 MHz	2.50 Ω	100 mA
L-07CR10#V6T	100 nH	±5% ±10%	8	100 MHz	850 MHz	2.50 Ω	100 mA
L-07CR12#V6T	120 nH	±5% ±10%	8	50 MHz	750 MHz	2.50 Ω	100 mA

## 0603 INDUCTANCE RANGE / ELECTRICAL CHARACTERISTICS

Part Number	Inductance	Tolerance	Q (Min.)	L/Q Freq.	Typical SRF	DC Resistance Max	Rated Current
L-14C1N0SV4T	1.0 nH	± 0.3 nH	8	100 MHz	>17000 MHz	0.10 Ω	300 mA
L-14C1N2SV4T	1.2 nH	± 0.3 nH	8	100 MHz	>17000 MHz	0.10 Ω	300 mA
L-14C1N5SV4T	1.5 nH	± 0.3 nH	8	100 MHz	>17000 MHz	0.10 Ω	300 mA
L-14C1N8SV4T	1.8 nH	± 0.3 nH	8	100 MHz	13000 MHz	0.10 Ω	300 mA
L-14C2N2SV4T	2.2 nH	± 0.3 nH	8	100 MHz	12000 MHz	0.15 Ω	300 mA
L-14C2N7SV4T	2.7 nH	± 0.3 nH	8	100 MHz	8600 MHz	0.15 Ω	300 mA
L-14C3N3@V4T	3.3 nH	± 0.3 nH ±10%	8	100 MHz	6500 MHz	0.20 Ω	300 mA
L-14C3N9@V4T	3.9 nH	± 0.3 nH ±10%	8	100 MHz	6300 MHz	0.20 Ω	300 mA
L-14C4N7@V4T	4.7 nH	± 0.3 nH ±10%	8	100 MHz	5400 MHz	0.20 Ω	300 mA
L-14C5N6@V4T	5.6 nH	± 0.3 nH ±10%	8	100 MHz	4600 MHz	0.25 Ω	300 mA
L-14C6N8#V4T	6.8 nH	±5% ±10%	8	100 MHz	4500 MHz	0.30 Ω	300 mA
L-14C8N2#V4T	8.2 nH	±5% ±10%	8	100 MHz	3800 MHz	0.33 Ω	300 mA
L-14C10N#V4T	10.0 nH	±5% ±10%	8	100 MHz	3700 MHz	0.35 Ω	300 mA
L-14C12N#V4T	12.0 nH	±5% ±10%	8	100 MHz	3200 MHz	0.40 Ω	300 mA
L-14C15N#V4T	15.0 nH	±5% ±10%	8	100 MHz	2900 MHz	0.45 Ω	300 mA
L-14C18N#V4T	18.0 nH	±5% ±10%	10	100 MHz	2100 MHz	0.50 Ω	300 mA
L-14C22N#V4T	22.0 nH	±5% ±10%	10	100 MHz	2100 MHz	0.55 Ω	300 mA
L-14C27N#V4T	27.0 nH	±5% ±10%	10	100 MHz	2000 MHz	0.60 Ω	300 mA
L-14C33N#V4T	33.0 nH	±5% ±10%	10	100 MHz	1600 MHz	0.65 Ω	300 mA
L-14C39N#V4T	39.0 nH	±5% ±10%	10	100 MHz	1500 MHz	0.70 Ω	300 mA
L-14C47N#V4T	47.0 nH	±5% ±10%	12	100 MHz	1200 MHz	0.90 Ω	300 mA

@ = Choice of S or K Tolerance, # = J or K Tolerance



## 0603 CONTINUED

Part Number	Inductance	Tolerance	Q (Min.)	L/Q Freq.	Typical SRF	DC Resistance Max	Rated Current
L-14C56N#V4T	56.0 nH	±5% ±10%	12	100 MHz	1100 MHz	1.00 Ω	300 mA
L-14C68N#V4T	68.0 nH	±5% ±10%	12	100 MHz	1000 MHz	1.10 Ω	300 mA
L-14C82N#V4T	82.0 nH	±5% ±10%	12	100 MHz	850 MHz	1.20 Ω	300 mA
L-14CR10#V4T	100 nH	±5% ±10%	12	100 MHz	750 MHz	1.20 Ω	300 mA
L-14CR12#V4T	120 nH	±5% ±10%	8	50 MHz	700 MHz	1.30 Ω	300 mA
L-14CR15#V4T	150 nH	±5% ±10%	8	50 MHz	650 MHz	1.40 Ω	300 mA
L-14CR18#V4T	180 nH	±5% ±10%	8	50 MHz	550 MHz	1.50 Ω	300 mA
L-14CR22#V4T	220 nH	±5% ±10%	8	50 MHz	450 MHz	1.70 Ω	300 mA

## 0805 INDUCTANCE RANGE / ELECTRICAL CHARACTERISTICS

Part Number	Inductance	Tolerance	Q (Min.)	L/Q Freq.	Typical SRF	DC Resistance Max	Rated Current
L-15C1N5SV4E	1.5 nH	± 0.3 nH	10	100 MHz	>6000 MHz	0.10 Ω	300 mA
L-15C1N8SV4E	1.8 nH	± 0.3 nH	10	100 MHz	>6000 MHz	0.10 Ω	300 mA
L-15C2N2SV4E	2.2 nH	± 0.3 nH	10	100 MHz	>6000 MHz	0.10 Ω	300 mA
L-15C2N7SV4E	2.7 nH	± 0.3 nH	12	100 MHz	>6000 MHz	0.12 Ω	300 mA
L-15C3N3@V4E	3.3 nH	± 0.3 nH ±10%	12	100 MHz	>6000 MHz	0.13 Ω	300 mA
L-15C3N9@V4E	3.9 nH	± 0.3 nH ±10%	12	100 MHz	5600 MHz	0.15 Ω	300 mA
L-15C4N7@V4E	4.7 nH	± 0.3 nH ±10%	12	100 MHz	5500 MHz	0.20 Ω	300 mA
L-15C5N6@V4E	5.6 nH	± 0.3 nH ±10%	12	100 MHz	4700 MHz	0.23 Ω	300 mA
L-15C6N8#V4E	6.8 nH	±5% ±10%	15	100 MHz	3900 MHz	0.25 Ω	300 mA
L-15C8N2#V4E	8.2 nH	±5% ±10%	15	100 MHz	3200 MHz	0.28 Ω	300 mA
L-15C10N#V4E	10.0 nH	±5% ±10%	15	100 MHz	3100 MHz	0.30 Ω	300 mA
L-15C12N#V4E	12.0 nH	±5% ±10%	15	100 MHz	2800 MHz	0.35 Ω	300 mA
L-15C15N#V4E	15.0 nH	±5% ±10%	15	100 MHz	2400 MHz	0.40 Ω	300 mA
L-15C18N#V4E	18.0 nH	±5% ±10%	15	100 MHz	2100 MHz	0.45 Ω	300 mA
L-15C22N#V4E	22.0 nH	±5% ±10%	15	100 MHz	2000 MHz	0.50 Ω	300 mA
L-15C27N#V4E	27.0 nH	±5% ±10%	15	100 MHz	1800 MHz	0.55 Ω	300 mA
L-15C33N#V4E	33.0 nH	±5% ±10%	15	100 MHz	1700 MHz	0.60 Ω	300 mA
L-15C39N#V4E	39.0 nH	±5% ±10%	18	100 MHz	1400 MHz	0.65 Ω	300 mA
L-15C47N#V4E	47.0 nH	±5% ±10%	18	100 MHz	1200 MHz	0.70 Ω	300 mA
L-15C56N#V4E	56.0 nH	±5% ±10%	18	100 MHz	1000 MHz	0.75 Ω	300 mA
L-15C68N#V4E	68.0 nH	±5% ±10%	18	100 MHz	900 MHz	0.80 Ω	300 mA
L-15C82N#V4E	82.0 nH	±5% ±10%	18	100 MHz	900 MHz	0.85 Ω	300 mA
L-15CR10#V4E	100 nH	±5% ±10%	18	100 MHz	700 MHz	0.90 Ω	300 mA
L-15CR12#V4E	120 nH	±5% ±10%	13	50 MHz	600 MHz	0.95 Ω	300 mA
L-15CR15#V4E	150 nH	±5% ±10%	13	50 MHz	500 MHz	1.00 Ω	300 mA
L-15CR18#V4E	180 nH	±5% ±10%	13	50 MHz	430 MHz	1.10 Ω	300 mA
L-15CR22#V4E	220 nH	±5% ±10%	12	50 MHz	400 MHz	1.20 Ω	300 mA
L-15CR27#V4E	270 nH	±5% ±10%	12	50 MHz	340 MHz	1.30 Ω	300 mA
L-15CR33#V4E	330 nH	±5% ±10%	12	50 MHz	320 MHz	1.50 Ω	300 mA
L-15CR39#V4E	390 nH	±5% ±10%	10	50 MHz	270 MHz	1.60 Ω	300 mA
L-15CR47#V4E	470 nH	±5% ±10%	10	50 MHz	250 MHz	1.80 Ω	300 mA
L-15CR56#V4E	560 nH	±5% ±10%	10	50 MHz	230 MHz	2.50 Ω	300 mA
L-15CR68#V4E	680 nH	±5% ±10%	10	50 MHz	180 MHz	3.00 Ω	300 mA

"@ = Choice of S or K Tolerance, # = J or K Tolerance"

## RF CHARACTERISTICS CHARACTERISTICS (TYPICAL)

INDUCTANCE VS FREQUENCY: SIZE 0402

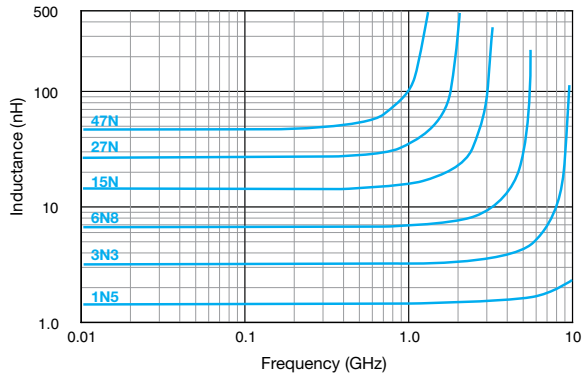

Q VS FREQUENCY: SIZE 0402

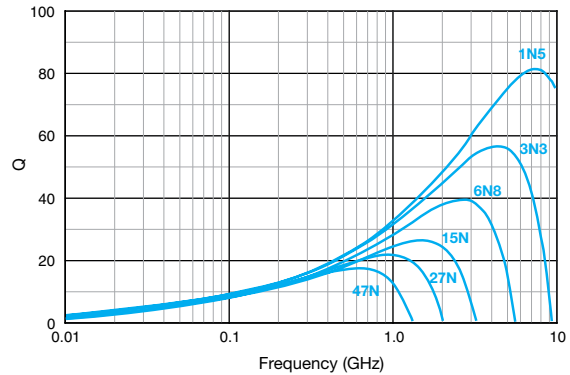

INDUCTANCE VS FREQUENCY: SIZE 0603

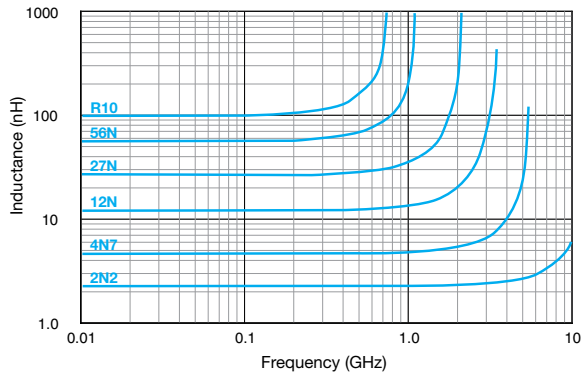

Q VS FREQUENCY: SIZE 0603

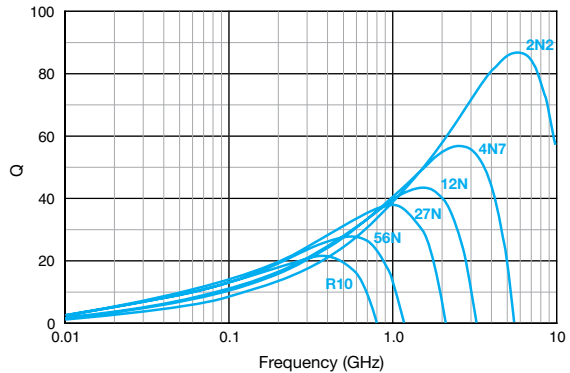

INDUCTANCE VS FREQUENCY: SIZE 0805

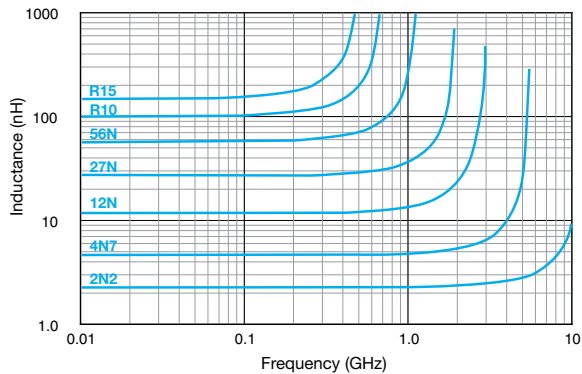

Q VS FREQUENCY: SIZE 0805

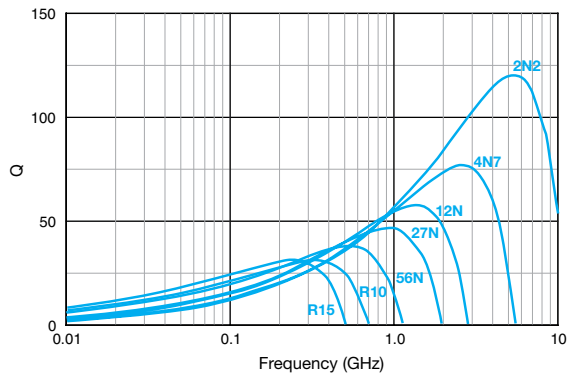

## MECHANICAL & ENVIRONMENTAL CHARACTERISTICS

### SPECIFICATION

<b>SOLDERABILITY:</b>	Solder coverage $\geq 75\%$ of electrodes L $\pm 10\%$ Q $\pm 20\%$
<b>RESISTANCE TO SOLDERING:</b>	No apparent damage Solder coverage $\geq 75\%$ L $\pm 10\%$ Q $\pm 20\%$
<b>THERMAL SHOCK:</b>	No apparent damage L $\pm 10\%$ Q $\pm 20\%$
<b>LIFE TEST:</b>	No apparent damage L $\pm 10\%$ Q $\pm 20\%$
<b>HUMIDITY RESISTANCE:</b>	Inductance change: 2% or .5pF Max
<b>TERMINAL ADHESION:</b>	Termination should not pull off. Ceramic should remain undamaged.
<b>PCB DEFLECTION:</b>	No mechanical damage.

### TEST PARAMETERS

Preheat 120 $\pm$ 20°C for 1 min. Dip 230 $\pm$ 10°C for 3 $\pm$ 1 sec.  
 Preheat 120 $\pm$ 20°C for 1 min. Dip 260 $\pm$ 10°C for 10 $\pm$ 1 sec.  
 100 cycles: 30 $\pm$ 3 minutes @ +100°C then 30 $\pm$ 3 min. @ -40°C  
 1000  $\pm$ 48 Hours @ +85 $\pm$ 2°C, rated current (1-2 hour recovery)  
 1000  $\pm$ 48 Hours @ +40 $\pm$ 2°C, 90-95% relative humidity, rated current (1-2 hour recovery)  
 Lateral pull force: 0201  $\geq$ 1.0Lbs 0402  $\geq$ 1.6Lbs  
 For 0603  $\geq$  2.2Lbs For 0805  $\geq$ 4.4Lbs  
 Glass Epoxy PCB: 1 mm deflection



# RF WIREWOUND CHIP INDUCTORS

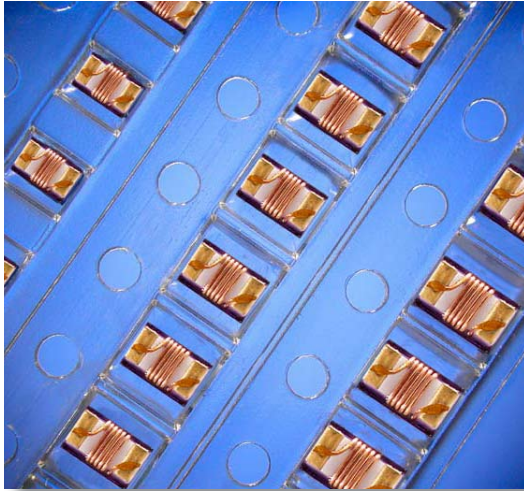

These high frequency High-Q chip inductors feature a monolithic body made of low loss ceramic wound with wire to achieve optimal high frequency performance.

These RF chip inductors are compact in size and are provided on tape and reel packaging which makes them ideal for high volume RF applications. They feature a nickel barrier with a top plating of gold for the ceramic core types (all 0402, all 0603, and most 0805 types), and with a top plating of 100% tin for the ferrite core types (0805 size, 470 nH and higher). Most inductance values between those listed are available on request.

## APPLICATIONS

- CELL/PCS Modules
- Wireless LAN
- Broadband Components
- RFID
- RF Transceivers
- Cordless Phone
- Cable Modem
- Computer Peripherals
- Bluetooth
- ASDL

## PRODUCT RANGE SUMMARY

EIA SIZE (mm)	SIZE CODE	L RANGE	Q FACTOR (Typ.)	SRF (Typ.)	TEMPERATURE
0402 (1005)	L-07	1.0 - 120 nH	55 (900 MHz)	>11 GHz (1.0 nH)	-40°C to + 125°C
0603 (1608)	L-14	2.0 - 470 nH	60 (900 MHz)	>13 GHz (2.0 nH)	-40°C to + 125°C
0805 (2012)	L-15	2.2 - 10,000 nH	60 (500 MHz)	>11 GHz (2.2 nH)	-40°C to + 125°C*

\*-40 deg. C to +85 deg. C for ferrite core types

## MECHANICAL CHARACTERISTICS

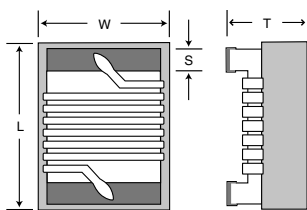

	0402 (1005)		0603 (1608)		0805 (2012)	
	Inches	mm	Inches	mm	Inches	mm
Length	.039 ±.004"	(1.00 ±.10)	.063 ±.008"	(1.60 ±.20)	.079 ±.008"	(2.00 ±.20)
Width	.022 ±.004"	(0.55 ±.10)	.041 ±.008"	(1.05 ±.20)	.049 ±.008"	(1.25 ±.20)
Thickness	.020 ±.004"	(0.50 ±.10)	.041 ±.008"	(1.05 ±.20)	.047 ±.008"	(1.20 ±.20)
End Band	.008 ±.004"	(0.20 ±.10)	.014 ±.004"	(0.35 ±.10)	.016 ±.004"	(0.40 ±.10)

## HOW TO ORDER

L-	07	W	4N3	S	V	4	T
DEVICE	SIZE	TYPE	VALUE	TOLERANCE*	TERMINATION	MARKING	TAPE & REEL
Inductor	07 = 0402 14 = 0603 15 = 0805	W = Wirewound on Ceramic Core F = Wirewound on Ferrite Core	See Table	C = ± 0.2 nH S = ± 0.3 nH G = ± 2% J = ± 5% K = ± 10%	V = Ni / Au for "W" types, and V = Ni / 100% Sn for "F" types	4 = No Marking	Size Code Tape Reel Qty 0402 T Paper 7" 10,000 0603 E Embossed 7" 3,000 0805 E Embossed 7" 2,000

Example Part Number:

**L-07W4N3SV4T** is: 0402 Wirewound, 4.3 nanohenry, +/- 0.3 nH tolerance, Ni / Au termination, No Marking, Paper tape on a 7" reel.

\* See selection chart on the following pages for available tolerances of each value.

## 0402 INDUCTANCE RANGE / ELECTRICAL CHARACTERISTICS

Part Number (Standard Tol.)	Inductance @250Mhz	Available Tolerances @250Mhz	Q (min.) @250Mhz	Q (Typ.) @900Mhz	Q (Typ.) @1.8Ghz	SRF (min.)	DC Resistance (max.)	Rated Current (max.)
L-07W1N0SV4T	1.0 nH	±0.2 nH, ±0.3 nH	13	49	60	6.0 Ghz	0.045 Ω	1360 mA
L-07W1N2SV4T	1.2 nH	±0.2 nH, ±0.3 nH	13	49	60	6.0 Ghz	0.060 Ω	1300 mA
L-07W1N8SV4T	1.8 nH	±0.2 nH, ±0.3 nH	16	50	60	6.0 Ghz	0.070 Ω	1040 mA
L-07W1N9SV4T	1.9 nH	±0.2 nH, ±0.3 nH	16	50	60	6.0 Ghz	0.070 Ω	1040 mA
L-07W2N0SV4T	2.0 nH	±0.2 nH, ±0.3 nH	16	51	62	6.0 Ghz	0.070 Ω	1040 mA
L-07W2N2SV4T	2.2 nH	±0.2 nH, ±0.3 nH	18	52	65	6.0 Ghz	0.070 Ω	960 mA
L-07W2N4SV4T	2.4 nH	±0.2 nH, ±0.3 nH	15	52	65	6.0 Ghz	0.068 Ω	790 mA
L-07W2N6SV4T	2.6 nH	±0.2 nH, ±0.3 nH	15	51	65	6.0 Ghz	0.120 Ω	640 mA
L-07W2N7SV4T	2.7 nH	±0.2 nH, ±0.3 nH	16	50	65	6.0 Ghz	0.120 Ω	640 mA
L-07W3N3JV4T	3.3 nH	±0.2 nH, ± 5%, ±10%	19	53	72	6.0 Ghz	0.066 Ω	840 mA
L-07W3N6JV4T	3.6 nH	±0.2 nH, ± 5%, ±10%	19	55	76	6.0 Ghz	0.066 Ω	840 mA
L-07W3N9JV4T	3.9 nH	±0.2 nH, ± 5%, ±10%	19	60	82	5.8 Ghz	0.066 Ω	840 mA
L-07W4N3JV4T	4.3 nH	±0.2 nH, ± 5%, ±10%	18	55	82	6.0 Ghz	0.091 Ω	700 mA
L-07W4N7JV4T	4.7 nH	±0.2 nH, ± 5%, ±10%	15	55	82	4.8 Ghz	0.130 Ω	640 mA
L-07W5N1JV4T	5.1 nH	±0.2 nH, ± 5%, ±10%	20	58	83	5.8 Ghz	0.083 Ω	800 mA
L-07W5N6JV4T	5.6 nH	±0.2 nH, ± 5%, ±10%	20	61	89	5.8 Ghz	0.083 Ω	760 mA
L-07W6N2JV4T	6.2 nH	±0.2 nH, ± 5%, ±10%	20	57	80	5.8 Ghz	0.083 Ω	760 mA
L-07W6N8JV4T	6.8 nH	±0.2 nH, ± 5%, ±10%	20	58	80	4.8 Ghz	0.083 Ω	680 mA
L-07W7N5JV4T	7.5 nH	±0.2 nH, ± 5%, ±10%	22	59	90	5.8 Ghz	0.104 Ω	680 mA
L-07W8N2JV4T	8.2 nH	±0.2 nH, ± 5%, ±10%	22	60	87	4.4 Ghz	0.104 Ω	680 mA
L-07W8N7JV4T	8.7 nH	±0.2 nH, ± 5%, ±10%	18	60	83	4.1 Ghz	0.200 Ω	480 mA
L-07W9N0JV4T	9.0 nH	±0.2 nH, ± 5%, ±10%	22	60	83	4.2 Ghz	0.104 Ω	680 mA
L-07W9N5JV4T	9.5 nH	±0.2 nH, ± 5%, ±10%	18	55	76	4.0 Ghz	0.200 Ω	680 mA
L-07W10NJV4T	10.0 nH	±2%, ± 5%, ±10%	21	56	76	3.9 Ghz	0.195 Ω	480 mA
L-07W11NJV4T	11.0 nH	±2%, ± 5%, ±10%	24	61	86	3.7 Ghz	0.120 Ω	640 mA
L-07W12NJV4T	12.0 nH	±2%, ± 5%, ±10%	24	58	77	3.6 Ghz	0.120 Ω	640 mA
L-07W13NJV4T	13.0 nH	±2%, ± 5%, ±10%	24	60	77	3.5 Ghz	0.210 Ω	560 mA
L-07W15NJV4T	15.0 nH	±2%, ± 5%, ±10%	24	61	86	3.3 Ghz	0.172 Ω	560 mA
L-07W16NJV4T	16.0 nH	±2%, ± 5%, ±10%	24	58	77	3.1 Ghz	0.220 Ω	560 mA
L-07W18NJV4T	18.0 nH	±2%, ± 5%, ±10%	24	58	77	3.1 Ghz	0.230 Ω	420 mA
L-07W19NJV4T	19.0 nH	±2%, ± 5%, ±10%	24	58	77	3.0 Ghz	0.202 Ω	480 mA
L-07W20NJV4T	20.0 nH	±2%, ± 5%, ±10%	24	54	74	3.0 Ghz	0.250 Ω	420 mA
L-07W22NJV4T	22.0 nH	±2%, ± 5%, ±10%	24	54	73	2.7 Ghz	0.300 Ω	400 mA
L-07W23NJV4T	23.0 nH	±2%, ± 5%, ±10%	24	55	73	2.7 Ghz	0.214 Ω	400 mA
L-07W24NJV4T	24.0 nH	±2%, ± 5%, ±10%	24	54	74	2.7 Ghz	0.300 Ω	400 mA
L-07W27NJV4T	27.0 nH	±2%, ± 5%, ±10%	24	55	75	2.5 Ghz	0.298 Ω	400 mA
L-07W30NJV4T	30.0 nH	±2%, ± 5%, ±10%	24	52	64	2.3 Ghz	0.300 Ω	400 mA
L-07W33NJV4T	33.0 nH	±2%, ± 5%, ±10%	24	52	64	2.3 Ghz	0.350 Ω	400 mA
L-07W36NJV4T	36.0 nH	±2%, ± 5%, ±10%	24	52	64	2.3 Ghz	0.403 Ω	320 mA
L-07W39NJV4T	39.0 nH	±2%, ± 5%, ±10%	24	51	48	2.1 Ghz	0.550 Ω	320 mA
L-07W40NJV4T	40.0 nH	±2%, ± 5%, ±10%	24	51	48	2.3 Ghz	0.438 Ω	320 mA
L-07W43NJV4T	43.0 nH	±2%, ± 5%, ±10%	24	50	46	2.0 Ghz	0.810 Ω	100 mA
L-07W47NJV4T	47.0 nH	±2%, ± 5%, ±10%	22*	50	46	2.1 Ghz	0.830 Ω	100 mA
L-07W51NJV4T	51.0 nH	+/- 5%, +/- 10%	22*	49	N/A	1.7 Ghz	0.820 Ω	100 mA
L-07W56NJV4T	56.0 nH	+/- 5%, +/- 10%	22*	49	N/A	1.7 Ghz	0.970 Ω	100 mA
L-07W68NJV4T	68.0 nH	+/- 5%, +/- 10%	22*	42	N/A	1.6 Ghz	1.120 Ω	100 mA
L-07W82NJV4T	82.0 nH	+/- 5%, +/- 10%	16**	39	N/A	1.5 Ghz	1.250 Ω	100 mA
L-07WR10JV4T	100.0 nH	+/- 5%, +/- 10%	16**	36	N/A	1.3 Ghz	2.520 Ω	100 mA
L-07WR11JV4T	110.0 nH	+/- 5%, +/- 10%	14**	35	N/A	1.2 GHz	2.600 Ω	100 mA
L-07WR12JV4T	120.0 nH	+/- 5%, +/- 10%	14**	35	N/A	1.1 Ghz	2.660 Ω	100 mA

\* 200 Mhz

\*\* 150 MHz

**NOTE: Most inductance values between those listed above are available on request.**

Rated current shown is for 15 degrees C rise

## 0603 INDUCTANCE RANGE / ELECTRICAL CHARACTERISTICS

Part Number (Standard Tol.)	Inductance @ L/Q Freq.	L/Q Test Freq.	Available Tolerances @L/Q Freq.	Q (min.) @L/Q Freq	SRF (min.)	DC Resistance (max.)	Rated Current (max.)
L-14W1N6SV4E	1.6 nH	250 Mhz	±0.2 nH, ±0.3 nH	14	7.0 GHz	0.080 Ω	700 mA
L-14W1N8SV4E	1.8 nH	250 MHz	±0.2 nH, ±0.3 nH	16	6.9 GHz	0.080 Ω	700 mA
L-14W2N0SV4E	2.0 nH	250 Mhz	±0.2 nH, ±0.3 nH	16	6.9 Ghz	0.080 Ω	700 mA
L-14W3N3SV4E	3.3 nH	250 MHz	±0.2 nH, ±0.3 nH	17	6.1 GHz	0.080 Ω	700 mA
L-14W3N6SV4E	3.6 nH	250 Mhz	±0.2 nH, ±0.3 nH	20	6.0 Ghz	0.080 Ω	700 mA
L-14W3N9SV4E	3.9 nH	250 Mhz	±0.2 nH, ±0.3 nH	22	5.9 Ghz	0.080 Ω	700 mA
L-14W4N3SV4E	4.3 nH	250 Mhz	±0.2 nH, ±0.3 nH	22	5.8 Ghz	0.060 Ω	700 mA
L-14W4N7SV4E	4.7 nH	250 Mhz	±0.2 nH, ±0.3 nH	20	5.8 Ghz	0.110 Ω	700 mA
L-14W5N1JV4E	5.1 nH	250 Mhz	±0.2 nH, ± 5%, ±10%	18	5.4 Ghz	0.110 Ω	700 mA
L-14W5N6JV4E	5.6 nH	250 MHz	±0.2 nH, ± 5%, ±10%	16	5.0 GHz	0.110 Ω	700 mA
L-14W6N8JV4E	6.8 nH	250 Mhz	±0.2 nH, ± 5%, ±10%	30	4.6 Ghz	0.110 Ω	700 mA
L-14W7R5JV4E	7.5 nH	250 MHz	±0.2 nH, ± 5%, ±10%	30	4.7 GHz	0.110 Ω	700 mA
L-14W8N2JV4E	8.2 nH	250 Mhz	±0.2 nH, ± 5%, ±10%	30	4.8 Ghz	0.100 Ω	700 mA
L-14W8N7JV4E	8.7 nH	250 Mhz	±2%, ± 5%, ±10%	30	4.6 Ghz	0.120 Ω	700 mA
L-14W10NJV4E	10.0 nH	250 Mhz	±2%, ± 5%, ±10%	31	4.0 Ghz	0.130 Ω	700 mA
L-14W11NJV4E	11.0 nH	250 MHz	±2%, ± 5%, ±10%	33	4.0 GHz	0.086 Ω	700 mA
L-14W12NJV4E	12.0 nH	250 Mhz	±2%, ± 5%, ±10%	35	4.0 Ghz	0.130 Ω	700 mA
L-14W15NJV4E	15.0 nH	250 Mhz	±2%, ± 5%, ±10%	35	3.1 Ghz	0.170 Ω	700 mA
L-14W18NJV4E	18.0 nH	250 Mhz	±2%, ± 5%, ±10%	38	3.0 Ghz	0.170 Ω	700 mA
L-14W22NJV4E	22.0 nH	250 Mhz	±2%, ± 5%, ±10%	38	3.0 Ghz	0.220 Ω	700 mA
L-14W27NJV4E	27.0 nH	250 Mhz	±2%, ± 5%, ±10%	40	2.8 Ghz	0.220 Ω	600 mA
L-14W33NJV4E	33.0 nH	250 Mhz	±2%, ± 5%, ±10%	43	2.3 Ghz	0.220 Ω	600 mA
L-14W39NJV4E	39.0 nH	250 Mhz	±2%, ± 5%, ±10%	43	2.2 Ghz	0.250 Ω	600 mA
L-14W47NJV4E	47.0 nH	200 Mhz	±2%, ± 5%, ±10%	40	2.0 Ghz	0.280 Ω	600 mA
L-14W51NJV4E	51.0 nH	200 Mhz	±2%, ± 5%, ±10%	40	1.9 Ghz	0.300 Ω	600 mA
L-14W56NJV4E	56.0 nH	200 Mhz	±2%, ± 5%, ±10%	40	1.9 Ghz	0.310 Ω	600 mA
L-14W68NJV4E	68.0 nH	200 Mhz	±2%, ± 5%, ±10%	40	1.7 Ghz	0.340 Ω	600 mA
L-14W72NJV4E	72.0 nH	150 Mhz	±2%, ± 5%, ±10%	35	1.7 Ghz	0.490 Ω	400 mA
L-14W82NJV4E	82.0 nH	150 Mhz	±2%, ± 5%, ±10%	35	1.7 Ghz	0.540 Ω	400 mA
L-14WR10JV4E	100.0 nH	150 Mhz	±2%, ± 5%, ±10%	35	1.4 Ghz	0.630 Ω	400 mA
L-14WR12JV4E	120.0 nH	150 Mhz	±2%, ± 5%, ±10%	35	1.3 Ghz	0.650 Ω	300 mA
L-14WR15JV4E	150.0 nH	150 Mhz	±2%, ± 5%, ±10%	35	1.0 Ghz	0.920 Ω	280 mA
L-14WR18JV4E	180.0 nH	100 Mhz	±2%, ± 5%, ±10%	30	1.0 Ghz	1.25 Ω	240 mA
L-14WR22JV4E	220.0 nH	100 Mhz	±2%, ± 5%, ±10%	30	1.0 Ghz	1.70 Ω	200 mA
L-14WR27JV4E	270.0 nH	100 Mhz	±2%, ± 5%, ±10%	30	1.0 Ghz	1.80 Ω	170 mA
L-14WR33JV4E	330.0 nH	100 MHz	± 5%, ±10%	25	900 MHz	3.60 Ω	150 mA
L-14WR39JV4E	390.0 nH	100 MHz	± 5%, ±10%	24	750 MHz	5.30 Ω	100 mA
L-14WR47JV4E	470.0 nH	100 MHz	± 5%, ±10%	23	700 MHz	5.60 Ω	100 mA

Parts shown are for one tolerance only. Tolerances available are as shown in the "Tolerance" column.

**NOTE: Most inductance values between those listed above are available on request.**

Rated current shown is for 15 degrees C rise



## 0805 INDUCTANCE RANGE / ELECTRICAL CHARACTERISTICS

Part Number (Standard Tol.)	Inductance @L Test Freq.	L Test Freq.	Available Tolerances @L Test Freq.	Q (min.) @Q Test Freq.	Q Test Freq.	SRF (min.)	DC Resistance (max.)	Rated Current (max.)
L-15W2N2SV4E	2.2 nH	250 Mhz	±0.2 nH, ±0.3 nH	50	1000 Mhz	>6000 Mhz	0.06 Ω	800 mA
L-15W2N7SV4E	2.7 nH	250 Mhz	±0.2 nH, ±0.3 nH	35	1000 Mhz	>6000 Mhz	0.08 Ω	800 mA
L-15W3N3SV4E	3.3 nH	250 Mhz	±0.2 nH, ±0.3 nH	60	1000 Mhz	>6000 Mhz	0.08 Ω	800 mA
L-15W3N9SV4E	3.9 nH	250 Mhz	±0.2 nH, ±0.3 nH	60	1000 Mhz	>6000 Mhz	0.06 Ω	600 mA
L-15W4N7SV4E	4.7 nH	250 Mhz	±0.2 nH, ±0.3 nH	60	1000 Mhz	5800 Mhz	0.06 Ω	600 mA
L-15W5N6JV4E	5.6 nH	250 Mhz	±0.2 nH, ± 5%, ±10%	60	1000 Mhz	5800 Mhz	0.08 Ω	600 mA
L-15W6N8JV4E	6.8 nH	250 Mhz	±0.2 nH, ± 5%, ±10%	60	1000 Mhz	5500 Mhz	0.06 Ω	600 mA
L-15W8N2JV4E	8.2 nH	250 Mhz	±0.2 nH, ± 5%, ±10%	60	1000 Mhz	5500 Mhz	0.06 Ω	600 mA
L-15W10NJV4E	10.0 nH	250 Mhz	±2%, ± 5%, ±10%	60	500 Mhz	4800 Mhz	0.08 Ω	600 mA
L-15W12NJV4E	12.0 nH	250 Mhz	±2%, ± 5%, ±10%	60	500 Mhz	4100 Mhz	0.08 Ω	600 mA
L-15W15NJV4E	15.0 nH	250 Mhz	±2%, ± 5%, ±10%	60	500 Mhz	3600 Mhz	0.08 Ω	600 mA
L-15W16NJV4E	16.0 nH	250 Mhz	±2%, ± 5%, ±10%	60	500 Mhz	3500 Mhz	0.08 Ω	600 mA
L-15W18NJV4E	18.0 nH	250 Mhz	±2%, ± 5%, ±10%	60	500 Mhz	3400 Mhz	0.08 Ω	600 mA
L-15W20NJV4E	20.0 nH	250 Mhz	±2%, ± 5%, ±10%	60	500 Mhz	3400 Mhz	0.08 Ω	600 mA
L-15W22NJV4E	22.0 nH	250 Mhz	±2%, ± 5%, ±10%	60	500 Mhz	3300 Mhz	0.10 Ω	600 mA
L-15W27NJV4E	27.0 nH	250 Mhz	±2%, ± 5%, ±10%	60	500 Mhz	2600 Mhz	0.12 Ω	600 mA
L-15W33NJV4E	33.0 nH	250 Mhz	±2%, ± 5%, ±10%	60	500 Mhz	2400 Mhz	0.15 Ω	500 mA
L-15W39NJV4E	39.0 nH	250 Mhz	±2%, ± 5%, ±10%	60	500 Mhz	2100 Mhz	0.18 Ω	500 mA
L-15W47NJV4E	47.0 nH	200 Mhz	±2%, ± 5%, ±10%	60	500 Mhz	1700 Mhz	0.15 Ω	500 mA
L-15W56NJV4E	56.0 nH	200 Mhz	±2%, ± 5%, ±10%	60	500 Mhz	1600 Mhz	0.25 Ω	500 mA
L-15W68NJV4E	68.0 nH	200 Mhz	±2%, ± 5%, ±10%	60	500 Mhz	1450 Mhz	0.27 Ω	500 mA
L-15W82NJV4E	82.0 nH	150 Mhz	±2%, ± 5%, ±10%	60	500 Mhz	1350 Mhz	0.32 Ω	500 mA
L-15WR10JV4E	100 nH	150 Mhz	±2%, ± 5%, ±10%	57	250 Mhz	1200 Mhz	0.43 Ω	500 mA
L-15WR12JV4E	120 nH	150 Mhz	±2%, ± 5%, ±10%	50	250 Mhz	1100 Mhz	0.48 Ω	500 mA
L-15WR15JV4E	150 nH	100 Mhz	±2%, ± 5%, ±10%	50	250 Mhz	950 Mhz	0.56 Ω	400 mA
L-15WR18JV4E	180 nH	100 Mhz	±2%, ± 5%, ±10%	50	250 Mhz	900 Mhz	0.78 Ω	400 mA
L-15WR22JV4E	220 nH	100 Mhz	±2%, ± 5%, ±10%	50	250 Mhz	860 Mhz	1.00 Ω	400 mA
L-15WR27JV4E	270 nH	100 Mhz	±2%, ± 5%, ±10%	45	250 Mhz	850 Mhz	1.46 Ω	350 mA
L-15WR33JV4E	330 nH	100 Mhz	±2%, ± 5%, ±10%	45	250 Mhz	800 Mhz	1.65 Ω	300 mA
L-15WR39JV4E	390 nH	100 Mhz	±2%, ± 5%, ±10%	45	250 Mhz	780 Mhz	2.20 Ω	210 mA
L-15FR47JV4E	470 nH	25 Mhz	± 5%, ±10%	45	100 Mhz	375 Mhz	0.95 Ω	500 mA
L-15FR56JV4E	560 nH	25 Mhz	± 5%, ±10%	45	100 Mhz	340 Mhz	1.10 Ω	450 mA
L-15FR68JV4E	680 nH	25 Mhz	± 5%, ±10%	35	100 Mhz	188 Mhz	1.20 Ω	400 mA
L-15FR82JV4E	820 nH	25 Mhz	± 5%, ±10%	35	100 Mhz	215 Mhz	1.50 Ω	300 mA
L-15F1R0JV4E	1000 nH	25 Mhz	± 5%, ±10%	35	50 Mhz	200 Mhz	2.13 Ω	180 mA
L-15F1R2JV4E	1200 nH	8 Mhz	± 5%, ±10%	15	8 Mhz	200 Mhz	2.38 Ω	150 mA
L-15F1R5JV4E	1500 nH	8 Mhz	± 5%, ±10%	15	8 Mhz	200 Mhz	2.90 Ω	130 mA
L-15F1R8JV4E	1800 nH	8 Mhz	± 5%, ±10%	15	8 Mhz	120 Mhz	3.00 Ω	120 mA
L-15F2R2JV4E	2200 nH	8 Mhz	± 5%, ±10%	15	8 Mhz	110 Mhz	3.10 Ω	110 mA
L-15F2R7JV4E	2700 nH	8 Mhz	± 5%, ±10%	15	8 Mhz	100 Mhz	3.50 Ω	100 mA
L-15F3R3JV4E	3300 nH	8 Mhz	± 5%, ±10%	15	8 Mhz	70 Mhz	2.30 Ω	210 mA
L-15F3R9JV4E	3900 nH	8 Mhz	± 5%, ±10%	15	8 Mhz	60 Mhz	2.50 Ω	200 mA
L-15F4R7JV4E	4700 nH	8 Mhz	± 5%, ±10%	15	8 Mhz	50 Mhz	2.80 Ω	180 mA
L-15F5R6JV4E	5600 nH	8 Mhz	± 5%, ±10%	15	8 Mhz	45 Mhz	3.00 Ω	160 mA
L-15F6R8JV4E	6800 nH	8 Mhz	± 5%, ±10%	15	8 Mhz	45 Mhz	3.20 Ω	130 mA
L-15F8R2JV4E	8200 nH	8 Mhz	± 5%, ±10%	15	8 Mhz	40 Mhz	3.50 Ω	120 mA
L-15F10RJV4E	10000 nH	8 Mhz	± 5%, ±10%	10	8 Mhz	40 Mhz	5.00 Ω	80 mA

Parts shown are for one tolerance only. Tolerances available are as shown in the "Tolerance" column.

**NOTE: Most inductance values between those listed above are available on request.**

**Rated current shown is for 15 degrees C rise**



# RF CHARACTERISTICS CHARACTERISTICS (TYPICAL)

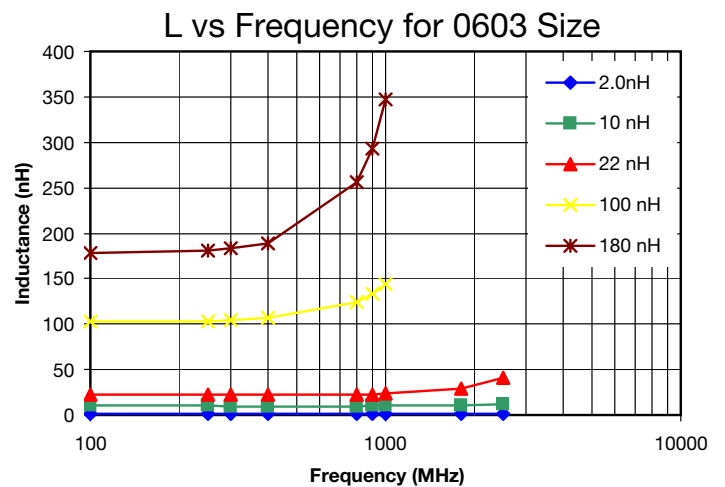
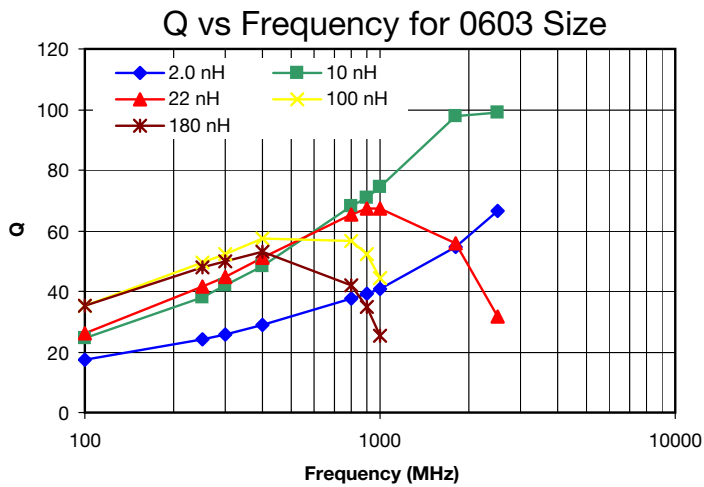
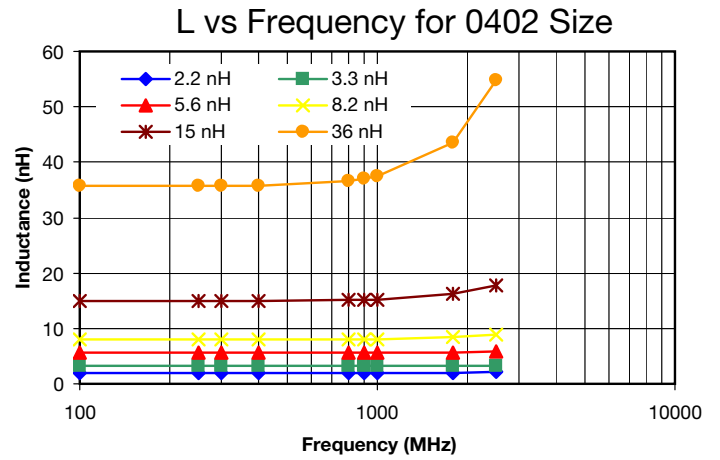
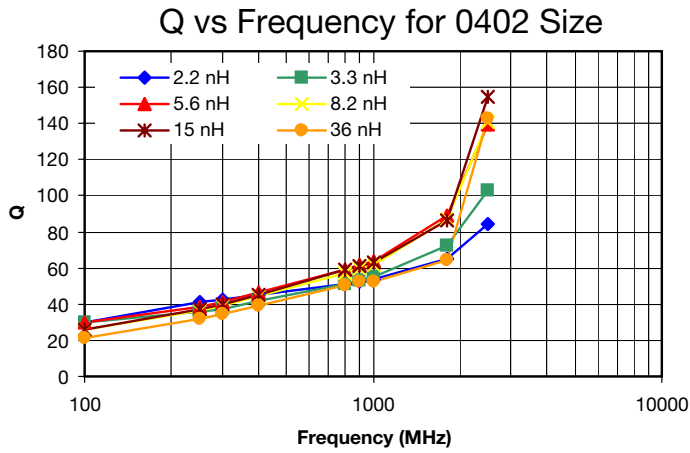

Q / ESR measured with an Agilent 4287A Impedance Analyzer and a 16193A fixture.  
 SRF measured with a HP 8720C Vector Network Analyzer using a Series-Through fixture.

## MECHANICAL & ENVIRONMENTAL CHARACTERISTICS

	SPECIFICATION	TEST PARAMETERS
<b>OPERATING TEMPERATURE RANGE</b>	Ceramic core: -40°C to +125°C Ferrite core: -40°C to +85°C	
<b>COEFFICIENT OF EXPANSION</b>	Ceramic Core: $7.2 \times 10^{-6}$ / deg. C (typ.) Ferrite Core: $10 \times 10^{-6}$ / deg. C (typ.)	
<b>INDUCTANCE AND TOLERANCE</b>	Within Specified Tolerance	Measuring Frequency : As shown in Product Table Measuring Temperature : + 25 °C
<b>QUALITY FACTOR</b>	Within Specified Tolerance	Measuring Frequency : As shown in Product Table Measuring Temperature : + 25 °C
<b>INSULATION RESISTANCE</b>	1000 mega ohms minimum	Measured at 100V DC between inductor terminals and center of case.
<b>DIELECTRIC WITHSTANDING VOLTAGE</b>	No damage occurs when the test voltage is applied.	Measured at 500V AC between inductor terminals and center of case for a maximum of 1 minute.
<b>TEMPERATURE COEFFICIENT OF INDUCTANCE (TCL)</b>	Ceramic Core: +25 to +125 ppm / °C Ferrite Core: +25 to +500 ppm / °C $TCL = \frac{L1 - L2}{L1(T1-T2)} \times 10^6 \text{ (ppm / } ^\circ\text{C)}$	Over - 40 °C to + 85°C at frequency specified in Product Table.
<b>COMPONENT ADHESION (PUSH TEST)</b>	0402 series - 350g 0603 series - 1.0Kg 0805 series - Minimum 2Kg for ceramic core parts and 1 Kg for ferrite core parts.	The component shall be reflow soldered onto a P. C. Board ( 230 °C ± 5°C for 20 seconds ). Then a dynamometer force gauge shall be applied to any side of the component.
<b>DROP TEST</b>	Change In Inductance: No more than 5% Change In Q: No more than 10% Change In Appearance: Without distinct damage	The inductor shall be dropped two times on a concrete floor or a vinyl tile from a 1 meter height.
<b>THERMAL SHOCK TEST</b>	Change In Inductance: No more than 5% Change In Q: No more than 10% Change In Appearance: Without distinct damage	Each cycle shall consist of 30 minutes at -40 °C followed by 30 minutes at +85 °C with a 20-second maximum transition time between temperature extremes. Test duration is 10 cycles.

## MECHANICAL & ENVIRONMENTAL CHARACTERISTICS

	SPECIFICATION	TEST PARAMETERS
<b>SOLDERABILITY</b>	A minimum of 80% of the metalized area must be covered with solder.	Dip pads in flux and dip in solder pot (63Sn / 37Pb) at 230 °C ± 5°C for 5 seconds.
<b>RESISTANCE TO SOLDERING HEAT</b>	Change In Inductance: No more than 5% Change In Q: No more than 10% Change in Appearance: Without distinct damage	Dip the components into flux and dip into solder pot containing 63Sn / 37Pb at 260 °C ± 5 °C for 5 ± 2 seconds.
<b>VIBRATION (RANDOM)</b>	Change In Inductance: No more than 5% Change In Q: No more than 10% Change in Appearance: Without distinct damage	Inductors shall be randomly vibrated at amplitude of 1.5mm and frequency of 10 - 55 Hz: 0.04 G / Hz for a minimum of 15 minutes per axis for each of the three axes.
<b>COLD TEMPERATURE STORAGE</b>	Change In Inductance: No more than 5% Change In Q: No more than 10% Change in Appearance: Without distinct damage	Inductors shall be stored at temperature of -40 °C ± 2 °C for 48 ± 2 hours. Then inductors shall be subjected to standard atmospheric conditions for 1 hour. After that, measurement shall be made.
<b>HIGH TEMPERATURE STORAGE</b>	Change In Inductance: No more than 5% Change In Q: No more than 10% Change in Appearance: Without distinct damage	Inductors shall be stored at temperature of 125 °C ± 2 °C for 48 ± 2 hours. Then inductors shall be subjected to standard atmospheric conditions for 1 hour. After that, measurement shall be made.
<b>MOISTURE RESISTANCE</b>	Inductors shall not have a shorted or open winding.	Inductors shall be stored in the chamber at 45 °C at 90 - 95 R. H. for 240 hours. Then inductors are to be tested after 2 hours at room temperature.
<b>HIGH TEMPERATURE WITH LOADED</b>	Inductors shall not have a shorted or open winding.	Inductors shall be stored in the chamber at +85 °C for 1000 hours with rated current applied. Inductors shall be tested at the beginning of test at 500 hours and 1000 hours. Then inductors are to be tested after 1 hour at room temperature.
<b>STATIC HUMIDITY</b>	Inductance must not change more than the stated tolerance.	Subjected to 85°C, 85% relative humidity for 100 hours. Inductors are to be tested after being air dried for two hours.
<b>RESISTANCE TO SOLVENT</b>	There must be no case deformation, change in dimensions, or obliteration of marking.	Must withstand 6 minutes of alcohol or water.

# INTEGRATED PASSIVE COMPONENTS



Johanson Technology has developed a line of small, highly reliable RF ceramic components manufactured with a proprietary LTCC (low temperature co-fired ceramic) process. These components operate over several bands from 900MHz to 6 GHz covering Cellular, DECT, WLAN, Bluetooth, 802.11 (a,b and g) and GPS applications.

In addition to the array of listed components we can support custom solutions for high volume applications with design flexibility and short development times. Contact us today with your specific technical requirements.

## KEY FEATURES

- Custom Solutions
- LTCC Based Designs
- Low Insertion Loss
- Miniature Size / Low Profile
- Temperature Stable
- Surface Mount
- RoHS Compliant, Standard, Use No Suffix

## SUPPORTED APPLICATION BANDS

- Wireless LAN, Bluetooth, Home RF
- GSM/EDGE/GPRS/DCS/PCS/WCDMA
- WiMAX 802.16
- 2.4 GHz & 5.5 GHz ISM Band
- Zigbee
- MiMo
- GPS
- UNII
- UWB

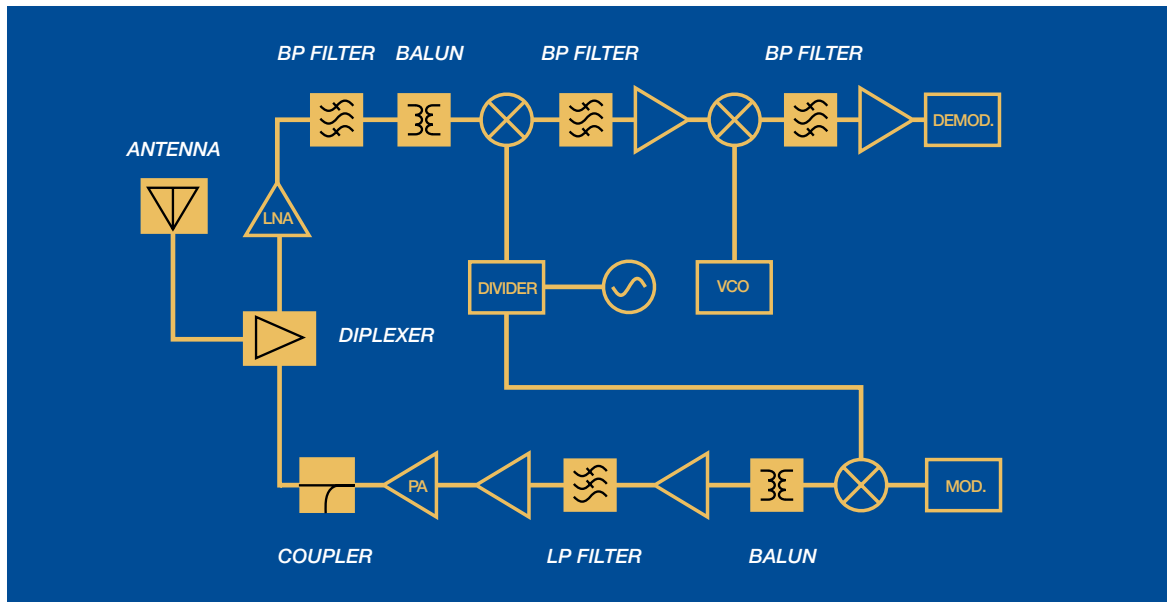

## CERAMIC CHIP ANTENNAS

Part Number	Frequency (MHz)	Peak Gain	Ave. Gain	Return Loss	Case Size
0920AT50A080	880 - 960	-0.7 dBi typ (XZ-V)	-2.6 dBi typ (XZ-V)	8.5 dB min.	Case 50
1575AT43A40	1555 - 1595	-1.5 dBi typ (XZ-V)	-2.5 dBi typ (XZ-V)	9.5 dB min.	Case 43-1
1575AT47A40_	1555 - 1595	-1.0 dBi typ (XZ-V)	-3.0 dBi typ (XZ-V)	9.5 dB min.	Case 47-1
2450AT18A100	2400 - 2500	0.5 dBi typ (XZ-V)	-0.5 dBi typ (XZ-V)	9.5 dB min.	Case 18-4
2450AT42A100	2400 - 2500	0 dBi typ (XZ-V)	-1 dBi typ (XZ-V)	9.5 dB min.	Case 42-1
2450AT42B100	2400 - 2500	0 dBi typ (XZ-V)	-1.5 dBi typ (XZ-V)	9.5 dB min.	Case 42-2
2450AT43A100	2400 - 2500	2.0 dBi typ (XZ-V)	0.5 dBi typ (XZ-V)	9.5 dB min.	Case 43-1
2450AT43B100	2400 - 2500	1.0 dBi typ (XZ-V)	-0.5 dBi typ (XZ-V)	9.5 dB min.	Case 43-2
2450AT44A100_	2400 - 2500	1.3 dBi typ (XZ-V)	0 dBi typ (XZ-V)	9.5 dB min.	Case 44-1
2450AT45A100_	2400 - 2500	3.0 dBi typ (XZ-V)	1.0 dBi typ (XZ-V)	9.5 dB min.	Case 45-1
2450AD46A5400 <b>(Dual Band)</b>	LB: 2400 - 2500 HB: 4900 - 5900	1.0 dBi typ (XZ-V) -2.5 dBi typ (XZ-V)	-1.5 dBi typ (YZ-V) -2.5 dBi typ (YZ-V)	8.5 dB min. 8.5 dB min.	Case 46-1
2500AT52M5355	<b>WiMax (Tri-Band)</b>	See spec sheet	See spec sheet	9.5 dB min.	TBD
5250AT43A200_	5150 - 5350	3.6 dBi typ (XZ-V)	-2.3 dBi typ (XZ-V)	9.5 dB min.	Case 43-1
5400AT18A1000	4900 - 5900	2.0 dBi typ. (XZ-V)	-2.5 dBi typ (XZ-V)	9.5 dB min.	Case 18-4
5775AT43A100_	5725 - 5825	3.9 dBi typ (XZ-V)	-1.5 dBi typ (XZ-V)	9.5 dB min.	Case 43-1

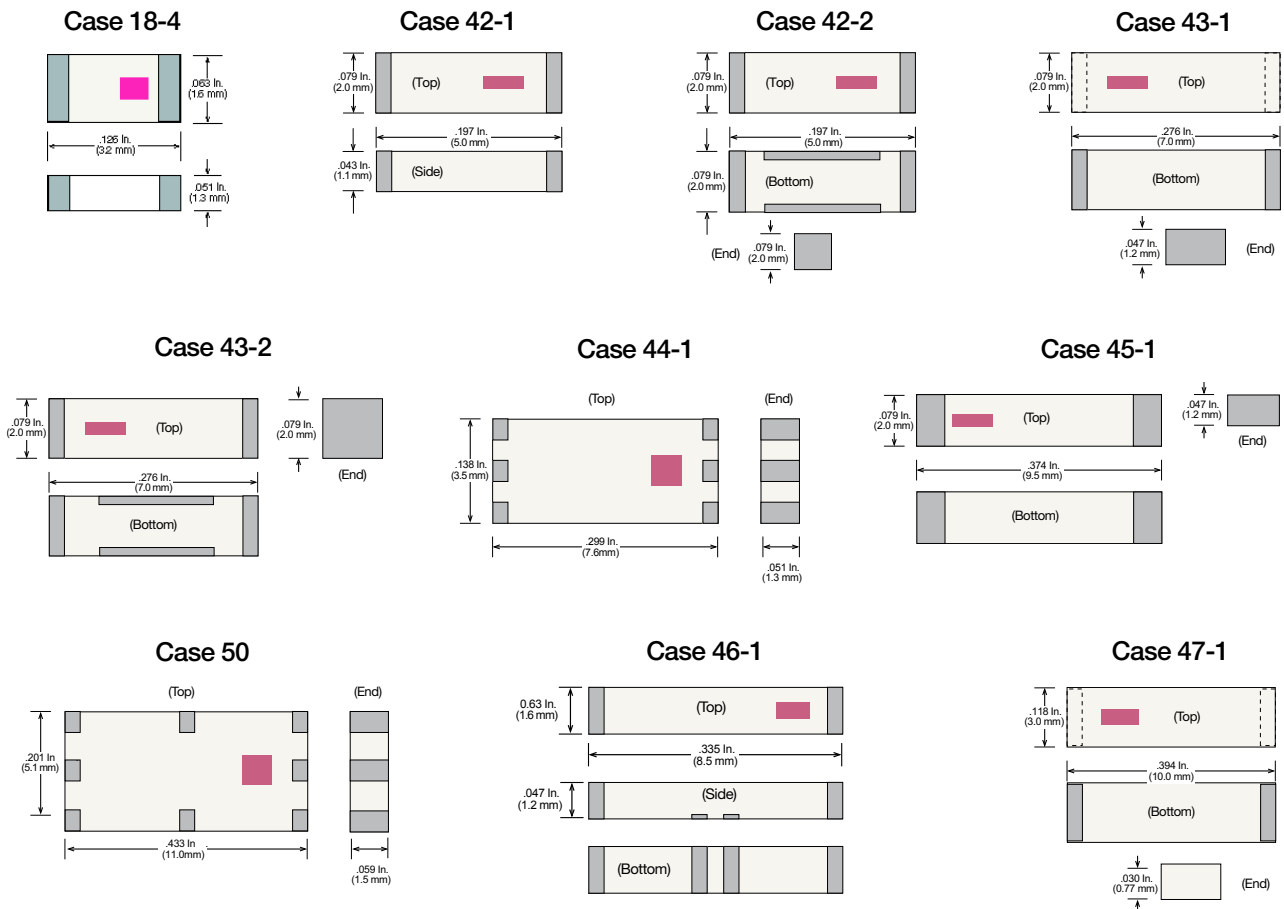

Detailed specifications and performance curves for the RF Ceramic Component line are located on our website.

## BAND-PASS FILTERS: 2.45 GHz

Part Number	Frequency (MHz)	Insertion Loss (max)	Attenuation (min)	Return Loss (min)	Ripple (typical)	Case Size
2450BP14C0100	2450 ± 50	2.0 dB	TBD	9.5 dB	-	Case 14-TBD
2450BP15B100	2450 ± 50	2.2 dB	25 dB @ 1200-1300 MHz 10 dB @ 2000 MHz 12 dB @ 3000 MHz 30 dB @ 3600-3800 MHz 34 dB @ 4800-5000 MHz	9.5 dB	-	Case 15-3
2450BP15D100	2450 ± 50	2.6 dB (Prelim.)	30 dB @ 880 - 1990 MHz (Prelim.) 20 dB @ 2110 - 2170 MHz (Prelim.) 30 dB @ 4800 - 5000 MHz (Prelim.) 20 dB @ 7200 - 7500 MHz (Prelim.)	9.5 dB	-	Case 15-1F
2450BP15C100	2450 ± 50	2.2 dB (Prelim.)	30 dB @ 1200-1300 MHz (Prelim.) 15 dB @ 2000 MHz (Prelim.) 25 dB @ 3000 MHz (Prelim.) 20 dB @ 3600-3800 MHz (Prelim.) 20 dB @ 4800-5000 MHz (Prelim.)	9.5 dB	-	Case 15-3B
2450BP15E0100	2450 ± 50	1.5 dB	TBD	9.5 dB	-	Case 15-3C
2450BP18C100A	2450 ± 50	2.5 dB	40 dB @ 1.2-1.8GHz 25 dB @ 2.1GHz 35 dB @ 4.8-5.0GHz 25 dB @ 7.2-7.5 GHz	9.5 dB	0.7 dB	Case 18-1
2450BP18C100B	2450 ± 50	2.0 dB	30 dB @ 1.75 GHz 25 dB @ 2.10 GHz 22 dB @ 4.8-5.0 GHz	9.5 dB	0.7 dB	Case 18-2
2450BP18C100C	2450 ± 50	2.5 dB	30 dB @ 1.2-1.8 GHz 25 dB @ 2.1 GHz 35 dB @ 4.8-5.0 GHz	9.5 dB	0.7 dB	Case 18-3A
2450BP18C100D	2450 ± 50	2.0 dB	40 dB @ 900-928 MHz 30 dB @ 1.2-1.8 GHz 25 dB @ 2.1 GHz 35 dB @ 4.8-5.0 GHz 30 dB @ 7.2-7.5 GHz	9.5 dB	0.7 dB	Case 18-3B
2450BP18D100A	2450 ± 50	TBD dB	TBD	TBD dB	TBD dB	Case 18-3C
2450BP39C100A	2450 ± 50	2.5 dB	42 dB @ 1.71-1.99 GHz 30 dB @ 2.1 GHz 30 dB @ 4.8-5.0 GHz	9.5 dB	0.7 dB	Case 39-1
2450BP39C100B	2450 ± 50	1.8 dB	30 dB @ 1.71-1.78 GHz 25 dB @ 1.85-1.91 GHz 25 dB @ 4.8-5.0 GHz	9.5 dB	0.7 dB	Case 39-1
2450BP39C100C	2450 ± 50	1.5 dB	30 dB @ 800-915 MHz 30 dB @ 1710-1785 MHz 25 dB @ 1850-1910 MHz 25 dB @ 4800-5000 MHz 15 dB @ 7200-7500 MHz	9.5 dB	-	Case 39-1
2450BP39D100B	2450 ± 50	2.5 dB	35 dB @ 880 - 915 MHz 18 dB @ 1710 - 1990 MHz 12 dB @ 2100 MHz 35 dB @ 3200 MHz 22 dB @ 4800 - 5000 MHz 22 dB @ 7200 - 7500 MHz	9.5 dB	-	Case 39-1

Basic case size drawings for above part numbers are located on page 37.

Detailed specifications and performance curves for the RF Ceramic Component line are located on our website.

## BAND-PASS FILTERS: 2.45 GHz

Part Number	Frequency (MHz)	Insertion Loss (max)	Attenuation (min)	Return Loss (min)	Ripple (typical)	Case Size
2450BP39D100C	2450 ± 50	1.2 dB	30 dB @ 880-915 MHz 30 dB @ 1710 - 1785 MHz 25 dB @ 1850 - 1910 MHz 25 dB @ 4800 - 5000 MHz 15 dB @ 7200 - 7500 MHz	9.5 dB	-	Case 39-1
2450BP39E100A	2450 ± 50	2.6 dB	42 dB @ 880 - 915 MHz 20 dB @ 1710 - 1990 MHz 8 dB @ 2110 - 2170 MHz 20 dB @ 2700 MHz 27 dB @ 4800 - 5000 MHz 15 dB @ 7200 - 7500 MHz	9.5 dB	-	Case 39-1
2450BP41D100	2450 ± 50	2.5 dB	40 dB @ 1.2-1.8 GHz 30 dB @ 2.1 GHz 35 dB @ 4.8-5.0 GHz	9.5 dB	0.7 dB	Case 41-1
2450BP41D100A	2450 ± 50	2.3 dB	40 dB @ 1.2-1.8 GHz 30 dB @ 2.1 GHz 12 dB @ 2.2 GHz 35 dB @ 4.8-5.0 GHz	9.5 dB	0.7 dB	Case 41-1
2450BP41D100B	2450 ± 50	1.3 dB	30 dB @ 880-915 MHz 30 dB @ 1.71-1.785 GHz 20 dB @ 1.85-1.91 GHz 25 dB @ 4.8-5.0 GHz 20 dB @ 7.2-7.5 GHz	9.5 dB	0.7 dB	Case 41-1

## BAND-PASS FILTERS: 5.5 GHz

Part Number	Frequency (MHz)	Insertion Loss (max)	Attenuation (min)	Return Loss (min)	Ripple	Case Size
5450BP15T600	5450 ± 300	2.0 dB (Prelim.)	25 dB @ 3.3 GHz (Prelim.) 15 dB @ 6.485 GHz (Prelim.) 25 dB @ 12 GHz (Prelim.)	NA	-	Case 15-3C
5487BP15B675	5150 - 5825	1.8 dB	35 dB @ 2.57-2.90 GHz 22 dB @ 10.3-11.6 GHz 30 dB @ 15.45-17.47 GHz	9.5 dB	0.7 dB	Case 15-1B
5487BP15C675	5150 - 5825	1.8 dB	35 dB @ 2.57-2.90 GHz 27 dB @ 10.3-11.65 GHz 20 dB @ 15.45-17.475 GHz	9.5 dB	0.7 dB	Case 15-1B
5515BP15B725	5150 - 5875	1.5 dB	30 dB @ 3500 MHz	9.5 dB	-	Case 15-3B
5515BP15B730	5150 - 5875	2.8 dB	30 dB @ 0.5-4.0 GHz 25 dB @ 10.3-11.8 GHz 20 dB @ 4.6 GHz	9.5 dB	0.7 dB	Case 15-1B
5515BP15B975	4900 - 5875	1.5 dB	30 dB @ 3500 MHz	9.5 dB	-	Case 15-3B
5515BP15C725	5150 - 5875	2.0 dB	30 dB @500-4000 MHz 20 dB @4600 MHz 15 dB @10.3-11.8 GHz	8.5 dB	-	Case 15-3B
5515BP15C975	4900 - 5875	1.8 dB	30 dB @ 500-4000MHz 20 dB @ 4200MHz 15 dB @ 9800-11750MHz	8.5 dB	-	Case 15-3B
5515BP15C1020	4900 - 5920	1.5 dB	30 dB @ 3500 MHz	9.5 dB	-	Case 15-3B

Basic case size drawings for above part numbers are located on page 37.

Detailed specifications and performance curves for the RF Ceramic Component line are located on our website.

## BAND-PASS FILTERS: OTHER

Part Number	Frequency (MHz)	Insertion Loss (max)	Attenuation (min)	Return Loss (min)	Ripple (typical)	Case Size
1810BP07B200	1800 ± 100	1.8 dB (Prelim.)	20 dB @ 855-955 (Prelim.) 10 dB @ 2565-2865 (Prelim.)	TBD	-	Case 07-1
1906BP18A027	1900 ± 50	1.5 dB	38 @ 1405-1440 MHz 10 @ 1649-1680 MHz 24 @ 3786-3840 MHz 20 @ 5679-5760 MHz	9.5 dB	-	Case 18-3B
1906BP18C027	1893-1920	2.0 dB	TBD	9.5 dB	-	Case 18-TBD
2593BP44B186	2500 - 2686	2.0 dB	40 dB @ 1870-2056 MHz	9.5 dB	-	Case 44-1
3600BP15M600	3300 - 3900 (Prelim)	1.8 dB (Prelim.)	15 dB @ 0.1-2.6 GHz (Prelim.) 9 dB @ 4.4 GHz (Prelim.) 20 dB @ 6.0-9.9 GHz (Prelim.)	9.5 dB (Prelim.)	-	Case 15-3B
4000BP15U1800	3100 - 4900	2.0 dB	25 dB @ 1.75 GHz 13 dB @ 2.10 GHz	8.5 dB	-	Case 15-2B
5130BP18U4060	3100 - 7160	1.6 dB	25 dB @ 824 - 960 MHz 25 dB @ 1710 - 1990 MHz 15 dB @ 2400 - 2500 MHz 20 dB @ 10100 - 10600 MHz	9.5 dB	-	Case 18-4

## HIGH-PASS FILTERS

Part Number	Frequency (MHz)	Insertion Loss (max)	Attenuation (min)	Return Loss (min)	Case Size
1900HP41A500	1900 ± 250	2.0 dB (Prelim)	30 dB @ 950 - 1450 MHz (Prelim)	8.5 dB	Case 41-1 (Prelim)
2450HP14A100	2450 ± 50	1.0 dB (Prelim.)	9 dB @ 824 - 960 MHz (Prelim.) 20 dB @ 1917 MHz (Prelim)	9.5 dB	Case 14-1B

## EMI FILTER

Part Number	No. of Sections	Cutoff Freq (MHz)	Attenuation (min)	Case Size
0200FA18A0200	4	200	20 dB @ 800 - 1200 MHz 10 dB @ 1500 - 3000 MHz	Case 18-4
0400FA15A0400	4	400	20 dB @ 800 - 1000 MHz	Case TBD
0400FA18A0400	4	400	20 dB @ 850 - 1200 MHz 10 dB @ 1500 - 2500 MHz	Case 18-4

Basic case size drawings for above part numbers are located on page 37.

Detailed specifications and performance curves for the RF Ceramic Component line are located on our website.



## LOW-PASS FILTERS

Part Number	Frequency (MHz)	Insertion Loss (max)	Attenuation (min)	Return Loss (min)	Case Size
0500LP15A500	0 - 500	0.70 dB	9 dB @ 824 - 960 MHz 25 dB @ 1710 - 1990 MHz 25 dB @ 2400 - 4000 MHz	9.5 dB	Case 15-1A
0869LP14A090	824 - 915	0.60 dB	20 dB @ 2xFo 15 dB @ 3xFo	10.9 dB	Case 14-1
0892LP07A136	824 - 960	0.70 dB	18 dB @ 1648 - 1920 MHz 25 dB @ 2472 - 2880 MHz 25 dB @ 3296 - 3840 MHz	9.5 dB	Case 07-1
0898LP18A035	880 - 915	0.60 dB	30 dB @ 2xFo 18 dB @ 3xFo	10.9 dB	Case 18-2
0915LP15A026	902 - 928	0.65 dB	25 dB @ 2xFo 25 dB @ 3xFo	9.5 dB	Case 15-2A
0915LP15B026	902 - 928	0.50 dB	30 dB @ 2xFo 30 dB @ 3xFo	14.0 dB	Case 15-2A
1200LP41A500	950 - 1450	2.0 dB (Prelim)	27 dB @ 1650 - 2150 MHz (Prelim)	8.5 dB	Case 41-1 (Prelim)
1748LP18A075	1710 - 1785	0.60 dB	30 dB @ 2xFo 18 dB @ 3xFo	10.9 dB	Case 18-2
1810LP07A200	1710 - 1910	0.50 dB	20 dB @ 2xFo 20 dB @ 3xFo	10.9 dB	Case 07-1
1810LP07B200	1710 - 1910	0.60 dB (Prelim)	26 dB @ 3420 - 3570 MHz (Prelim) 21 dB @ 3700 - 3820 MHz (Prelim) 21 dB @ 5130 - 5730 MHz (Prelim)	9.5 dB	Case 07-1
1810LP14A200	1710 - 1910	0.60 dB	30 dB @ 3420 - 3570 MHz 25 dB @ 3700 - 3820 MHz 20 dB @ 5130 - 5730 MHz	11.7 dB	Case 14-1
1880LP14A060	1850 - 1910	0.60 dB	27 dB @ 2xFo 19 dB @ 3xFo	11.7 dB	Case 14-1
2442LP18A083	2400 - 2483	0.60 dB	30 dB @ 2xFo 18 dB @ 3xFo	10.9 dB	Case 18-2
2450LP14A100	2400 - 2500	0.50 dB	25 dB @ 2xFo 18 dB @ 3xFo	14.0 dB	Case 14-1
2450LP14B100	2400 - 2500	0.50 dB	35 dB @ 2xFo 25 dB @ 3xFo	14.0 dB	Case 14-1
2450LP14C100	2400 - 2500	0.60 dB	27 dB @ 2xFo 25 dB @ 3xFo	11.7 dB	Case 14-1
2450LP15A050	2400 - 2500	0.50 dB	27 dB @ 2xFo 25 dB @ 3xFo	10.9 dB	Case 14-1
3550LP14A300	3400 - 3700	0.65 dB	25 dB @ 2xFo 25 dB @ 3xFo	14.0 dB	Case 14-1
5515LP15A730	5150 - 5875	0.50 dB	25 dB @ 2xFo	10.9 dB	Case 15-2A

Basic case size drawings for above part numbers are located on page 37.

Detailed specifications and performance curves for the RF Ceramic Component line are located on our website.

## DIRECTIONAL COUPLERS

Part Number	Frequency (MHz)	Insertion Loss (max)	Return Loss (min)	Coupling (dB)	Isolation (min.)	Case Size
0848CP14A075	810 - 885	0.25 dB	15.6 dB	20.3 ± 1.0 dB	28.0 dB	Case 14-1
0869CP14A090	824 - 915	0.3 dB	15.6 dB	17 ± 1.0 dB	26.0 dB	Case 14-1
0898CP14A035	880 - 915	0.28 dB	15.6 dB	18 ± 1.0 dB	26.0 dB	Case 14-1
0898CP14B035	880 - 915	0.25 dB	15.6 dB	20 ± 1.0 dB	28.0 dB	Case 14-1
0898CP15A035	880 - 915	0.50 dB	14.0 dB	20 ± 1.0 dB	25.0 dB	Case 15-1C
0967CP14A024	955 - 979	0.50 dB	15.6 dB	12.5 ± 1.0 dB	19.0 dB	Case 14-1
1747CP14A075	1710 - 1785	0.44 dB	15.6 dB	14.5 ± 1.0 dB	25.0 dB	Case 14-1
1748CP15A075	1710 - 1785	0.50 dB	14.0 dB	20 ± 1.0 dB	25.0 dB	Case 15-1C
1810CP14A200	1710 - 1910	0.30 dB	15.6 dB	20 ± 1.0 dB	25.0 dB	Case 14-1
2450CP14A100	2400 - 2500	0.74 dB	TBD dB	10 ± 1.0 dB	22.0 dB	Case 14-1
2450CP14B100	2400 - 2500	0.34 dB	TBD dB	17.65 ± 1.0 dB	25.0 dB	Case 14-1
5000CP14A200	4000 - 6000	TBD dB	TBD dB	20 ± TBD dB	25.0 dB (Prelim.)	Case 14-1

## DIRECTIONAL COUPLER - SPLITTER, 3 dB HYBRID

Part Number	Frequency (MHz)	Insertion Loss (max)	Return Loss (min)	Isolation (min.)	Case Size
0880CH15A060	850 - 910	3.3 ± 0.5 dB	14.0 dB	20.0 dB	Case 15-4
1950CH15A100	1900 - 2000	3.3 ± 0.5 dB	14.0 dB	16.0 dB	Case 15-4

## DIRECTIONAL COUPLER WITH LOW PASS FILTER

Part Number	Frequency (MHz)	Insertion Loss (max)	Return Loss (min)	Coupling (dB)	Isolation (min.)	Attenuation (min.) 2 x Fo 3 x Fo	Case Size
0898CF15A035_	880 - 915	0.7 dB	14 dB	20 ± 1.0	25.0 dB	22.0 dB 17.0 dB	Case 15-1C
1748CF15A075_	1710 - 1785	0.5 dB	14 dB	20 ± 1.0	25.0 dB	22.0 dB 17.0 dB	Case 15-1C

## DIRECTIONAL COUPLER - DUAL BAND, SINGLE PATH

Part Number	Frequency (MHz)	Insertion Loss (max)	Return Loss (min)	Coupling (dB)	Isolation (min.)	Case Size
0869CP14B1050	B1) 824 - 915	0.4 dB	15.6 dB	14.2 ± 1.0	23.0 dB	Case 14-1
	B2) 999 - 1102	0.6 dB	15.6 dB	12.7 ± 1.0	22.0 dB	

## DIRECTIONAL COUPLER - DUAL BAND, DUAL PATH

Part Number	Frequency (MHz)	Insertion Loss (max)	Return Loss (min)	Coupling (dB)	Isolation (min.)	Case Size
0898CD15B1748	B1) 880 - 915	0.40 dB	10.9 dB	19.2 ± 1.0	B1 In > B2 Out: 35.0 dB B1 In > B2 In: 25.0 dB B1 Out > B2 In: 25.0 dB B1 In > Term: 23.0 dB B2 In > Term: 23.0 dB	Case 15-2A
	B2) 1710 - 1785	0.4 dB	10.9 dB	19.2 ± 1.0		
0898CD15C1748	B1) 1710 - 1785	0.45 dB	10.9 dB	14.0 ± 1.5	B1 In > B2 Out: 35.0 dB B1 In > B2 In: 24.0 dB B1 Out > B2 In: 24.0 dB B1 In > Term: 24.0 dB B2 In > Term: 24.0 dB	Case 15-2A
	B2) 880 - 915	0.35 dB	10.9 dB	19.2 ± 1.0		
0898CD15D1748	B1) 880 - 915	0.35 dB	14.0 dB	19.0 ± 1.0	B1 In > B2 Out: 25.5 dB B1 In > B2 In: 21.0 dB B1 Out > B2 In: 22.0 dB B1 In > Term: 17.0 dB B2 In > Term: 24.0 dB	Case 15-2A
	B2) 1710 - 1785	0.50 dB	14.0 dB	14.0 ± 1.5		

## CERAMIC CHIP BALUNS

Part Number	Frequency (MHz)	Impedance Unbal./Bal.	Insertion Loss (max)	Return Loss (min)	Phase Difference	Amplitude Difference (max)	Case Size
0866BL15C200	800 - 900	50/200	TBD	TBD	180°±TBD°	TBD	Case 15-1D
0896BL14B050	851 - 941	50/50	1.5 dB	9.5 dB	180°±07°	0.7 dB	Case 14-1
0900BL15C050	800 - 1000	50/50	1.2 dB	9.5 dB	180°±10°	2.0 dB	Case 15-1D
0900BL18B100	889 -945	50/100	1.0 dB	9.5 dB	180°±10°	2.0 dB	Case 18-1
0900BL18B200	800 -1000	50/200	1.0 dB	9.5 dB	180°±10°	2.0 dB	Case 18-1
1450BL15A200	1400 -1500	50/200	1.0 dB	9.5 dB	180°±10°	2.0 dB	Case 15-1B
1600BL15B050	1500~1700	50/50	1.0 dB	9.5 dB	180°±10°	2.0 dB	Case 15-1B
1600BL15B100	1500~1700	50/100	1.0 dB	9.5 dB	180°±10°	2.0 dB	Case 15-1B
1800BL18B200	1700 - 1900	50/200	0.8 dB	9.5 dB	180°±10°	2.0 dB	Case 18-1
1850BL15B050	1700 - 2000	50/50	1.0 dB	9.5 dB	180°±10°	2.0 dB	Case 15-1B
1850BL15B100	1700 - 2000	50/100	1.0 dB	9.5 dB	180°±10°	2.0 dB	Case 15-1B
1850BL15B200	1700 - 2000	50/200	1.0 dB	9.5 dB	180°±10°	2.0 dB	Case 15-1B
2100BL18B200	2000 - 2200	50/200	0.8 dB	9.5 dB	180°±10°	2.0 dB	Case 18-1
2450BL14B050	2400 - 2500	50/50	1.5 dB	9.5 dB	180°±10°	2.0 dB	Case 14-1
2450BL14B100	2400 - 2500	50/100	1.3 dB	9.5 dB	180°±10°	2.0 dB	Case 14-1
2450BL14C050	2400 - 2500	50/50	1.2 dB	9.5 dB	180°±10°	2.0 dB	Case 14-1
2450BL14C100	2400 - 2500	50/100	1.2 dB	9.5 dB	180°±10°	1.5 dB	Case 14-1
2450BL14C200	2400 - 2500	50/200	1.3 dB	9.5 dB	180°±10°	2.0 dB	Case 14-1
2450BL15B050	2400 - 2500	50/50	1.0 dB	9.5 dB	180°±10°	2.0 dB	Case 15-1B
2450BL15B100	2400 - 2500	50/100	1.0 dB	9.5 dB	180°±10°	2.0 dB	Case 15-1B
2450BL15B150	2400 - 2500	50/150	1.0 dB	9.5 dB	180°±10°	2.0 dB	Case 15-1B
2450BL15B200	2400 - 2500	50/200	1.0 dB	9.5 dB	180°±10°	2.0 dB	Case 15-1B
2450BL15K050	2400 - 2500	50/50	1.2 dB	9.5 dB	180°±10°	2.0 dB	Case 15-1B
2450BL15K100	2400 - 2500	50/100	1.2 dB	9.5 dB	180°±10°	2.0 dB	Case 15-1B
2500BL14M050	2300 - 2700	50/50	1.2 dB (Prelim)	9.5 dB	180°±15°	1.5 dB	Case 14-1
2500BL14M100	2300 - 2700	50/100	1.2 dB (Prelim)	9.5 dB	180°±15°	1.5 dB	Case 14-1
3600BL14M050	3300 - 3900	50/50	1.2 dB (Prelim)	9.5 dB	180°±15°	1.5 dB	Case 14-1
3600BL14M100	3300 - 3900	50/100	1.2 dB (Prelim)	9.5 dB	180°±15°	1.5 dB	Case 14-1
3700BL15B050	3400 - 4000	50/50	1.2 dB	9.5 dB	180°±25°	2.0 dB	Case 15-1B
3700BL15B100	3400 - 4000	50/100	1.0 dB	9.5 dB	180°±20°	1.0 dB	Case 15-1B
3700BL15B200	3400 - 4000	50/200	1.2 dB	9.5 dB	180°±20°	1.0 dB	Case 15-1
4000BL14U100	3100 - 4800	50/100	1.2 dB	9.5 dB	180°±20°	1.5 dB	Case 14-1
5250BL14B100	5150 - 5350	50/100	1.0 dB	9.5 dB	180°±15°	1.5 dB	Case 14-1
5250BL15B100	5150 - 5350	50/100	1.2 dB	9.5 dB	180°±10°	2.0 dB	Case 15-1B
5325BL15B050	5150 - 5500	50/50	1.0 dB	9.5 dB	180°±10°	2.0 dB	Case 15-1B
5400BL14B100	5350 - 5450	50/100	1.2 dB (Prelim.)	TBD	TBD	TBD	Case 14-1
5400BL15B200	4900 - 5875	50/200	1.0 dB	9.5 dB	180°±10°	2.0 dB	Case 15-1B
5400BL15K050	4900 - 5875	50/50	1.2 dB	8.5 dB	180°±10°	2.0 dB	Case 15-1A
5512BL15B100	5150 - 5875	50/100	1.0 dB	11.7 dB	180°±10°	2.0 dB	Case 15-1B
5400BL15B050	4900 - 5900	50/50	1.0 dB	9.5 dB	180°±10°	2.0 dB	Case 15-1B
5400BL15B100	4900 - 5900	50/100	1.0 dB	9.5 dB	180°±10°	2.0 dB	Case 15-1B
5800BL15B100	5725 - 5875	50/100	1.0 dB	9.5 dB	180°±8°	0.75 dB	Case 15-1B

Detailed specifications and performance curves for the RF Ceramic Component line are located on our website.

## BALUNS / MATCHING NETWORKS; SPECIFIC CHIPSET APPLICATIONS

Part Number	Frequency (MHz)	Unbalanced Impedance	Balanced Impedance	Insertion Loss (max)	Return Loss (min)	Phase Difference	Case Size
2450BM18A001	Tx: 2400 - 2500 Rx: 2400 - 2500	50 50	51.4 - j151.9 @ 2.45 GHz 6.5 - j43.8 @ 2.45 GHz	4.2 dB 5.0 dB	9.5 dB 9.5 dB	180°±10° 180°±10°	Case 18-4

## CERAMIC CHIP BALUN FILTER

Part Number	Frequency (MHz)	Impedance Unbal./Bal.	Insertion Loss (max)	Return Loss (min)	Phase Difference	Case Size
2450FB15A050	2400 - 2500	50/50	1.5 dB	9.5 dB	180°±10°	Case 15-1A
2450FB39A050	2400 - 2500	50/50	2.0 dB	9.5 dB	180°±10°	Case 39-2
2450FB39B100	2400 - 2500	50/100	2.0 dB	9.5 dB	180°±10°	Case 39-2
2450FB39K001	2400 - 2500	50 / 22+j100	3.0 dB	9.5 dB	180°± 8°	Case TBD

## CERAMIC CHIP BALUNS, DUAL BAND

Part Number	Frequency (MHz)	Impedance Unbal./Bal.	Insertion Loss (max)	Return Loss (min)	Phase Difference	Case Size
0918BD41B050	B1: 900 - 940 B2: 1850 - 1920	50/50 50/50	1.2 dB 1.7 dB	8.5 dB 8.5 dB	180°±10° 180°±10°	Case 41-2

## CERAMIC CHIP DIPLEXERS - LPF / HPF

Part Number	Frequency (MHz)	Attenuation Low Band	Attenuation High Band	Return Loss (min.)	Case Size
0920DP18A1795_	880 - 960 1710 - 1880	0.75 dB max. 20 dB min.	20 dB min. 0.55 dB max.	12 dB 12 dB	Case 18-1
0967DP18A1795_	954 - 980 1710 - 1880	0.75 dB max. 20 dB min.	20 dB min. 0.55 dB max.	12 dB 12 dB.	Case 18-1
0859DP18A1920_	824 - 894 1850 - 1990	0.55 dB max. 20 dB min.	20 dB min. 0.55 dB max.	12 dB 12 dB	Case 18-1
0892DP14A1850_	824 - 960 1710 - 1990	0.50 dB max. 15 dB min.	25 dB min. 0.80 dB max.	12 dB 12 dB	Case 14-1
2450DP15A5512	2400 - 2500 5150 - 5875	0.70 dB max. 20 dB min.	15 dB min. 0.90 dB max.	9.5 dB 9.5 dB	Case 15-2A*
2450DP15B5512	2400 - 2500 5150 - 5875	0.70 dB max. 20 dB min.	15 dB min. 0.90 dB max.	9.5 dB 9.5 dB	Case 15-2A* * (opposite pin outs)

## CERAMIC CHIP DIPLEXERS - LPF / BPF

Part Number	Frequency (MHz)	Attenuation Low Band	Attenuation High Band	Return Loss (min.)	Case Size
2450DP15E5400	2400 - 2500 4900 - 5900	0.70 dB max. 20 dB min.	17 dB min. 1.60 dB max.	9.5 dB 9.5 dB	Case 15-1B# # (opposite pin outs)
2450DP15D5400	2400 - 2500 4900 - 5900	0.70 dB max. 20 dB min.	19 dB min. 1.40 dB max.	9.5 dB 9.5 dB	Case 15-1B#
2450DP15F5400 (Prelim.)	2400 - 2500 4900 - 5900	0.70 dB max. 20 dB min.	19 dB min. 1.40 dB max.	9.5 dB 9.5 dB	Case 15-1D (Ultra Low Profile)

## CERAMIC CHIP DIPLEXERS - OPTIMIZED FOR HARMONIC REJECTION

Part Number	Frequency (MHz)	Attenuation Low Band	Attenuation High Band	Return Loss (min.)	Case Size
0892DP14B1850	824 - 960 1710 - 1990	0.60 dB max. 15 dB min.	20 dB min. 0.90 dB max.	9.5 dB 9.5 dB	Case 14-1
0892DP15B1850	824 - 960 1710 - 1990	TBD dB max. TBD dB min.	TBD dB min. TBD dB max.	9.5 dB 9.5 dB	Case 15-1D
2400DP39B5425	2400 - 2500 4900 - 5900	2.50 dB min. 20 dB max.	17 dB max. 1.50 dB min.	9.5 dB 9.5 dB	Case 39-3B

Basic case size drawings for above part numbers are located on page 37.

Detailed specifications and performance curves for the RF Ceramic Component line are located on our website.

**Case 07-1 (EIA 0402/ 1005)**

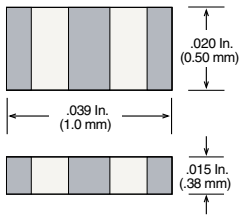

**Case 14-1 (EIA 0603/ 1608)**

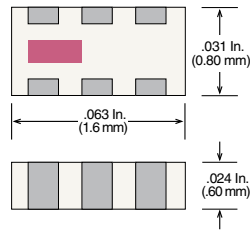

**Case 15-1 (EIA 0805 / 2012)**

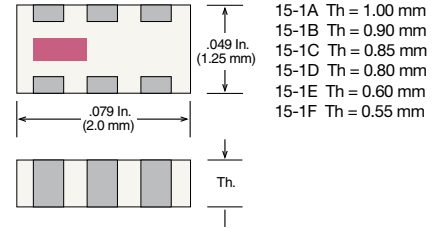

**Case 15-2 (EIA 0805 / 2012)**

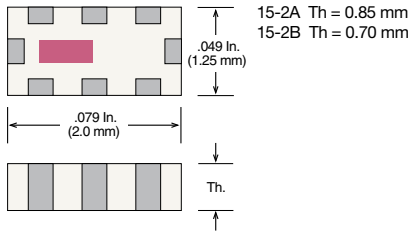

**Case 15-3 (EIA 0805 / 2012)**

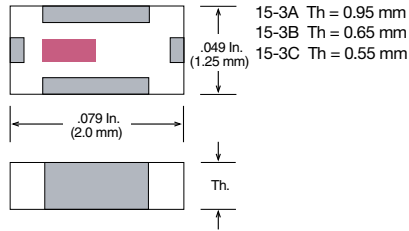

**Case 15-4 (EIA 0805 / 2012)**

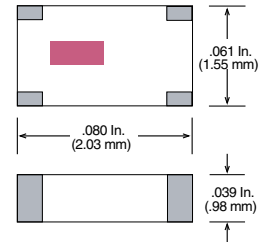

**Case 18-1 (EIA 1206 / 3216)**

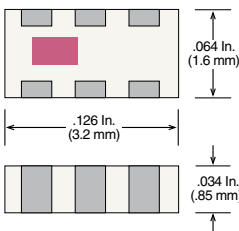

**Case 18-2 (EIA 1206 / 3216)**

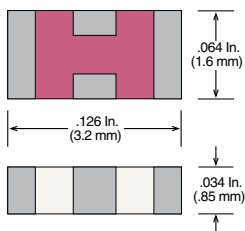

**Case 18-3 (EIA 1206 / 3216)**

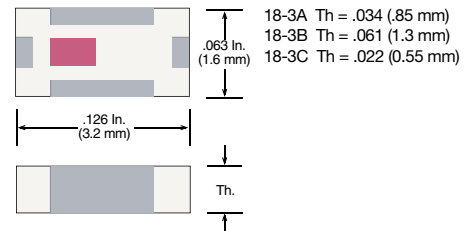

**Case 18-4 (EIA 1206 / 3216)**

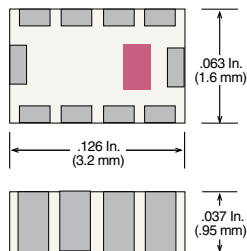

**Case 39-1 (2025)**

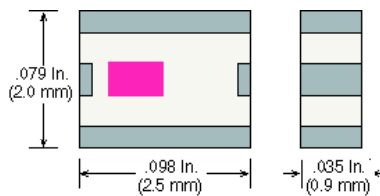

**Case 39-2 (2025)**

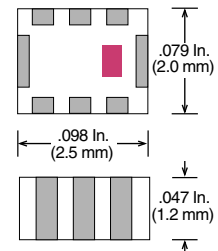

**Case 39-3 (2025)**

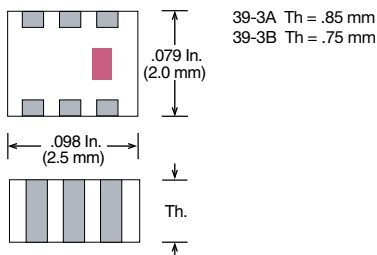

**Case 41-1 (EIA 1210 / 3225)**

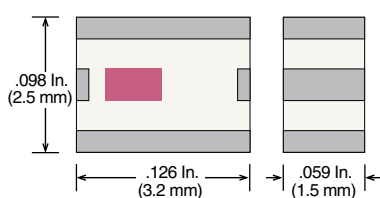

**Case 41-2 (EIA 1210 / 3225)**

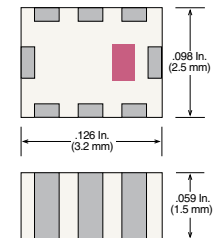

Detailed specifications and performance curves for the RF Ceramic Component line are located on our website.

## CUSTOM LTCC MODULE FOUNDRY SERVICE

Johanson Technology has the capability to produce a wide range of application specific components for wireless communication such as Diplexer Switch, VCO, PA and highly integrated RF modules using LTCC (Low Temperature Co-fired Ceramic) technology. We offer extensive expertise using an internally developed LTCC tape system.

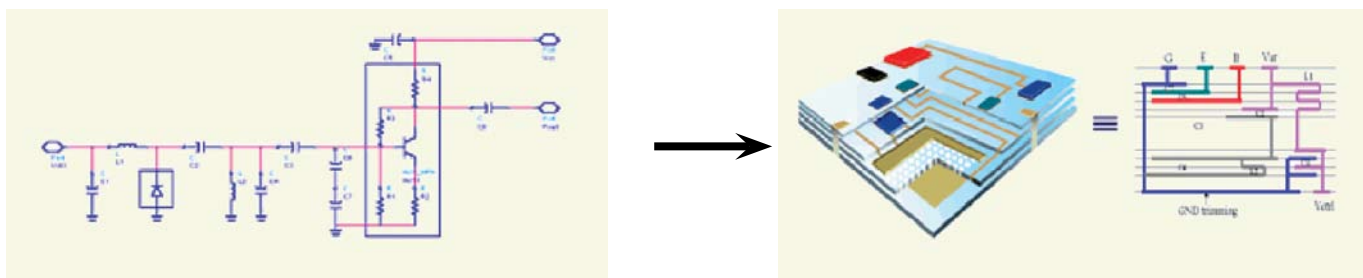

Design Rules	Standard (mm)	Advanced (mm)
(A) Via Hole Dia	0.125, 0.180	0.06 (min.)
(B) Via Cover Dot Dia	$\geq \text{Via} + 0.03$	$\geq \text{Via} + 0.02$
(C) Via Center Spacing	$\geq 0.20$ (for 0.07 via)	$\geq 0.18$ (for 0.05 via)
(D) Via Cover Dot Edge to Line Edge	$> 0.10$	$> 0.08$
(E) Line Width	$\geq 0.10$	$\geq 0.05$
(F) Line to Line Spacing	$\geq 0.10$	$\geq 0.08$
(G) Line Center Spacing	$\geq 0.18$	$\geq 0.13$
(H) Outside Edge to Via Center	$\geq 0.15$	$\geq 0.135$
(I) Line Over Outside Edge for Cutting	$> 0.05$	$> 0.05$
(J) Outside Edge to Line Clearance	$> 0.10$	$> 0.10$
(M) Buried Ground Plane Spacing	0.10	0.10
(N) Feed Thru Spacing	0.15	0.10
Substrate Thickness	0.5 to 1.6	0.3 to 2.4
Number of Layers	Up to 20	Up to 30

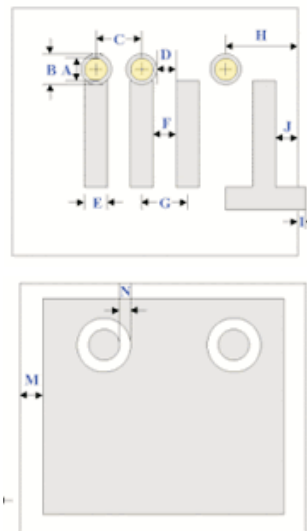

LTCC Tape Characteristics	JTI
Dielectric Constant (@ 3GHz)	7.5
Dielectric Loss (@ 3GHz)	0.33%
TCE (25-300°C) (ppm/°C)	4.7

# LASERTRIM® SMT TUNER CAPACITORS

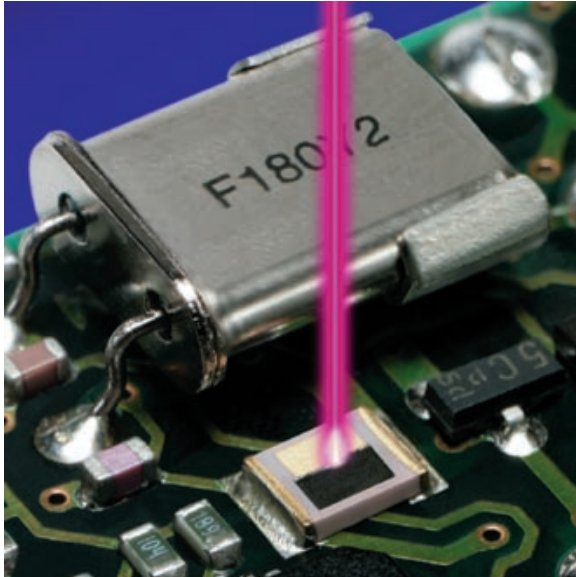

## KEY FEATURES

- RoHS Compliant Parts Available
- Automates Functional Tuning
- High Resolution, High Accuracy Tuning Capability
- Highly Stable and Reliable After Adjustment
- Small, Standard SMD Chip Sizes
- Lower Placement Cost vs Mechanical

## APPLICATIONS

- Portable Cellular Products
- Cable Modems
- Wireless Transceivers
- Wireless LAN
- RFID
- Custom Applications

LASERtrim® tuning capacitors are laser adjustable monolithic ceramic surface mount devices for precise functional tuning of RF circuits. LASERtrims® have the high reliability expected of conventional multi-layer chip capacitors and do not experience capacitance drift, flux entrapment and other reliability concerns associated with mechanical trimmers. Excellent post-trim Q and ESR performance are exhibited at frequencies of 100 - 2000 MHz. Offered in chip sizes 0603 to 1210 with nickel barrier terminations and tape and reel packaging, LASERtrims® are compatible with high volume SMT auto-placement and reflow techniques. These high quality, drift-free devices are ideally suited for functional tuning applications in oscillator, filter, and antenna circuits in a variety of wireless RF products.

## MODEL SELECTION

Part Number	RoHS P/N	EIA Case Size	CAPACITANCE		QUALITY FACTOR	
			Initial	Tuning Range	200 MHz	900 MHz
500L14N6R0XG4	500L14N6R0XG4	0603	6.0 pF	6.0 - 1.00 pF	> 40	---
500L14N100XG4	500L14N100XG4	0603	10.0 pF	10.0 - 2.00 pF	> 125	---
500L14N120XG4	500L14N120XG4	0603	12.0 pF	12.0 - 2.00 pF	> 125	---
500L15L6R0XG4	500L15M6R0XG4	0805	6.0 pF	6.0 - 1.00 pF	> 300	> 35
500L15N100XG4	500L15N100XG4	0805	10.0 pF	10.0 - 1.20 pF	> 75	---
500L15N200XG4	500L15N200XG4	0805	20.0 pF	20.0 - 1.50 pF	> 50	---
500L18C2R0XG4	500L18S2R0XG4	1206	2.0 pF	2.0 - 0.50 pF	> 600	> 100
500L18L3R0XG4	500L18M3R0XG4	1206	3.0 pF	3.0 - 1.0 pF	> 500	---
500L18L4R0XG4	500L18M4R0XG4	1206	4.0 pF	4.0 - 1.00 pF	> 500	---
500L18L6R5XG4	500L18M6R5XG4	1206	6.5 pF	6.5 - 1.20 pF	> 300	> 40
500L18N100XG4	500L18N100XG4	1206	10.0 pF	10.0 - 2.00 pF	> 125	---
500L41C2R5XG4	500L41S2R5XG4	1210	2.5 pF	2.5 - 0.50 pF	> 600	> 125
500L41C3R2XG4	500L41S3R2XG4	1210	3.2 pF	3.2 - 0.50 pF	> 450	> 125
500L41L7R0XG4	500L41M7R0XG4	1210	7.0 pF	7.0 - 1.50 pF	> 400	---
101L41L7R0XG4	101L41M7R0XG4	1210	7.0 pF	7.0 - 1.50 pF	> 400	---
500L41L120XG4	500L41M120XG4	1210	12.0 pF	12.0 - 2.00 pF	> 200	> 25
500L41N210XG4	500L41N210XG4	1210	21.0 pF	21.0 - 3.00 pF	> 75	---

Initial capacitance has a tolerance of + 25% - 0%. Trim ranges are approximate and vary with laser settings and trim pattern. Custom LASERtrims® with features and performance tailored for specific applications are available.



## TUNING DESCRIPTION

LASERtrim® tuning capacitors are used to provide functional RF circuitry tuning. The tuning is normally performed at a laser station integrated into the automated assembly line at a point beyond any operations that may significantly alter the circuit's RF characteristics. Tuning is performed by a computer controlled YAG laser beam which removes or "trims" the top electrode material of the LASERtrim® thereby decreasing its capacitance. Circuit parameters such as frequency or voltage are monitored during tuning and fed back to the laser controller achieving extremely precise results. Typical capacitance change in relation to the amount of electrode removal is shown in the graphs below.

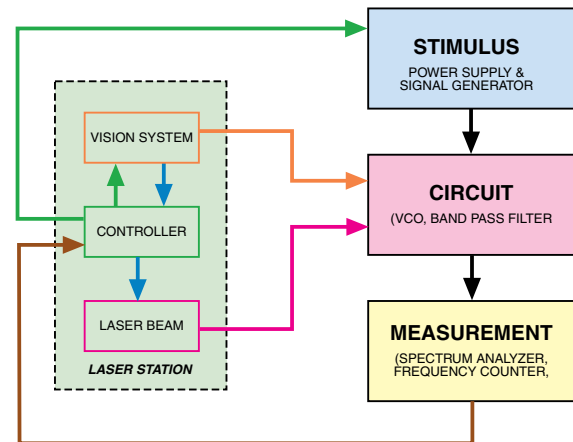

Sectional Diagram: Sizes L14 & L15

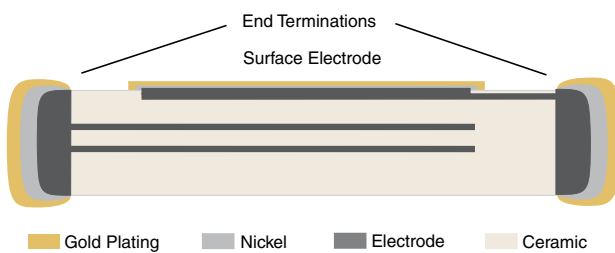

Sectional Diagram: Sizes L18 & L41

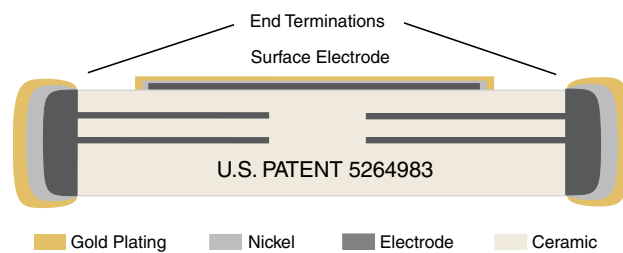

Trimming Effect on Capacitance

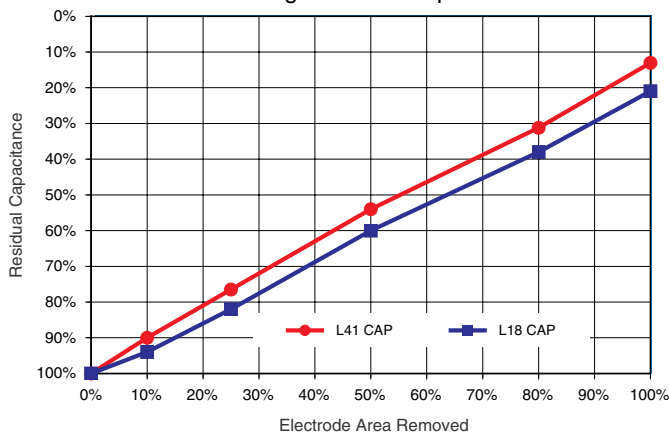

Typical Series Resonant Frequency

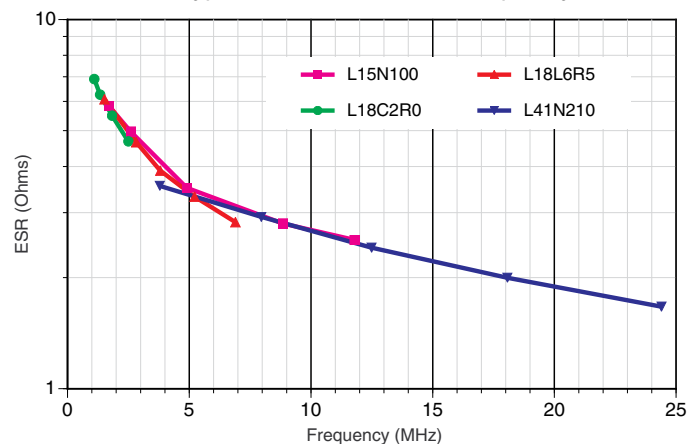



TYPICAL QUALITY FACTOR: L15N100

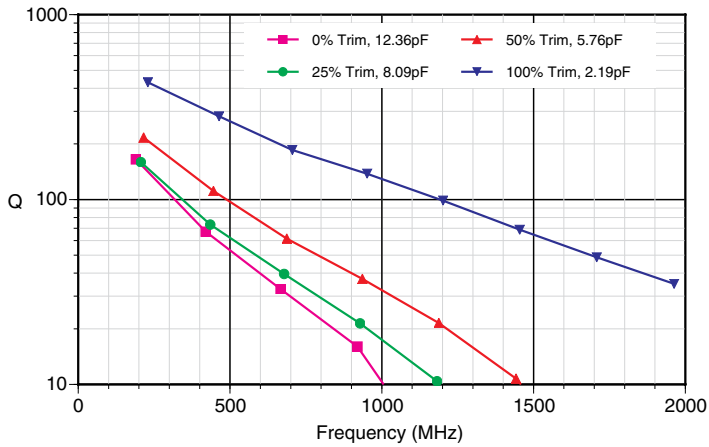

TYPICAL ESR: L15N100

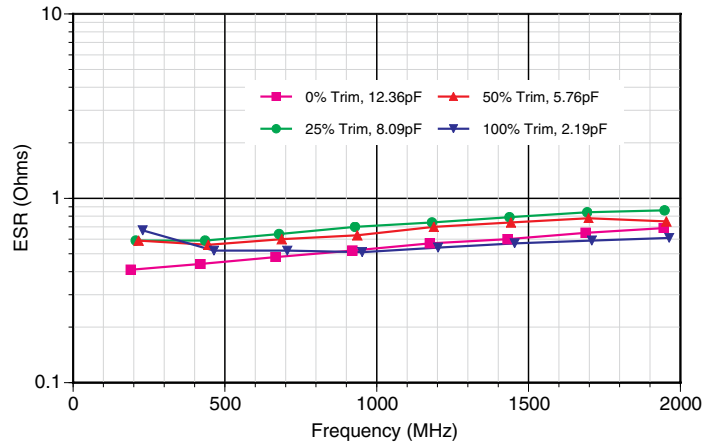

TYPICAL QUALITY FACTOR: L18C2R0

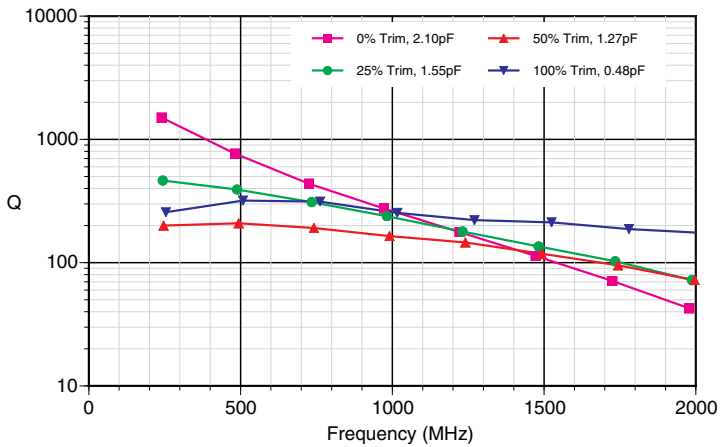

TYPICAL ESR: L18C2R0

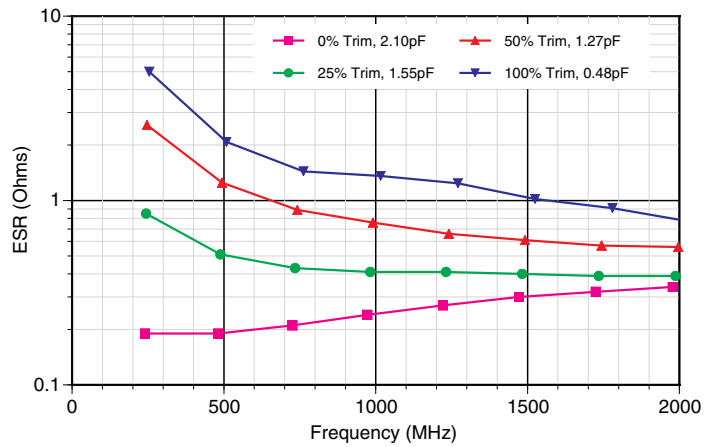

TYPICAL QUALITY FACTOR: L18L6R5

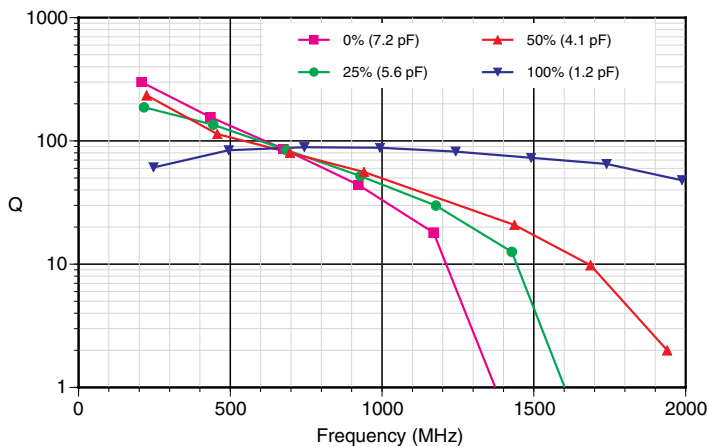

TYPICAL ESR: L18L6R5

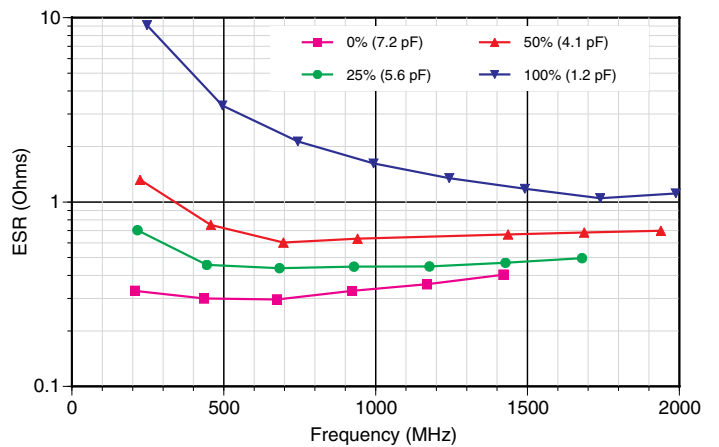

For L41 size electrical characteristics and graphs, please contact the factory.

## MECHANICAL CHARACTERISTICS

SIZE	L14 (EIA 0603)		L15 (EIA 0805)		L18 (EIA 1206)		L41 (EIA 1210)	
	Inches	(mm)	Inches	(mm)	Inches	(mm)	Inches	(mm)
<b>L</b>	.058 ±.008	(1.47 ±.20)	.080 ±.008	(2.00 ±.20)	.122 ±.008	(3.09 ±.20)	.130 ±.008	(3.30 ±.20)
<b>W</b>	.032 ±.008	(0.81 ±.20)	.050 ±.008	(1.27 ±.20)	.060 ±.008	(1.52 ±.20)	.100 ±.008	(2.54 ±.20)
<b>T</b>	.025 MAX	(0.64 MAX)	.025 ±.005	(0.64 ±.13)	.025 ±.005	(0.64 ±.13)	.025 ±.005	(0.64 ±.13)
<b>x &amp; y</b>	.004 MIN	(0.10 MIN)	.004 MIN	(0.10 MIN)	.004 MIN	(0.10 MIN)	.004 MIN	(0.10 MIN)
<b>E/B</b>	.005 MAX	(0.13 MAX)	.005 MIN	(0.13 MIN)	.005 MIN	(0.13 MIN)	.005 MIN	(0.13 MIN)
<b>E/B*</b>	.012 MAX	(0.30 MAX)	N/A (L14 Only)		N/A (L14 Only)		N/A (L14 Only)	

  

## ELECTRICAL CHARACTERISTICS

<b>WORKING VOLTAGE:</b>	50 Volts DC
<b>TEMPERATURE COEFFICIENT:</b>	0 ± 30ppm /°C, -55 to 125°C
<b>DISSIPATION FACTOR:</b>	.001 (0.1%) max, 25°C
<b>INSULATION RESISTANCE:</b>	> 10 GΩ @ 25°C, WVDC; 125°C IR is 10% of 25°C rating.
<b>DIELECTRIC STRENGTH:</b>	2.5 X WVDC, 25°C, 50 mA max
<b>TEST PARAMETERS:</b>	1MHz ±50kHz, 1.0±0.2 VRMS, 25°C
<b>ENVIRONMENTAL:</b>	Meets the mechanical & environmental characteristics as given for the JTI S-Series capacitors (see second page of S-Series specification sheet), except terminal adhesion for all sizes is > 2.0 lbs.

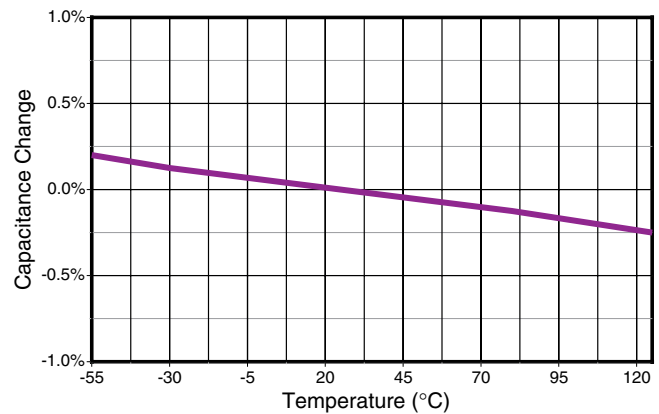

## HOW TO ORDER

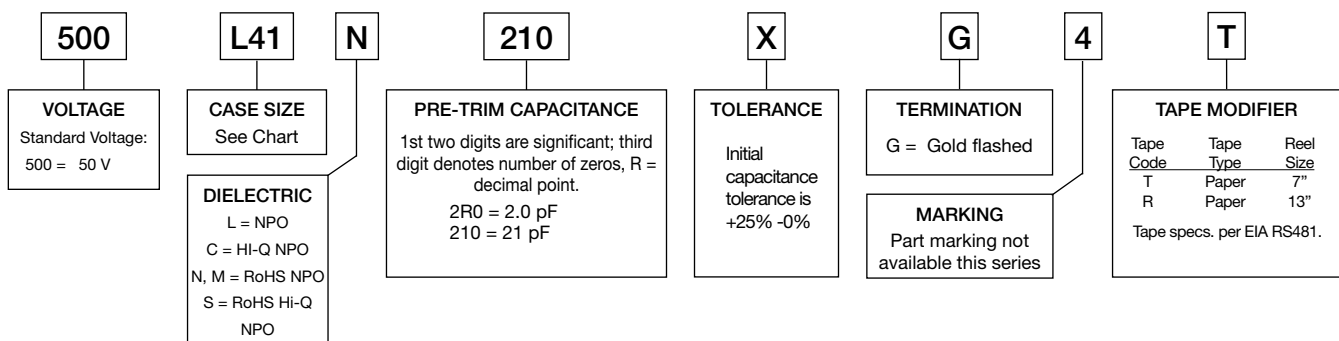

# GBBL BROADBAND SINGLE LAYER CAPACITORS

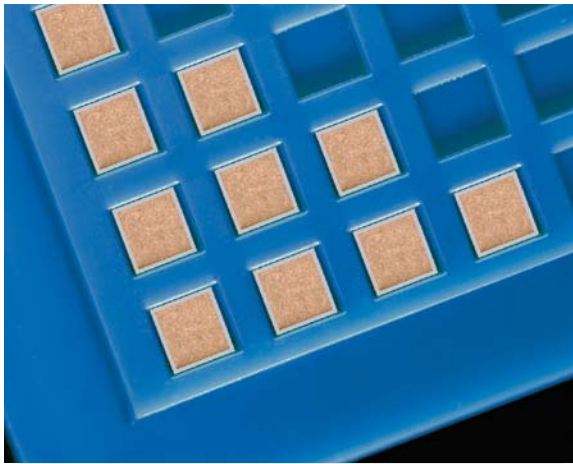

## KEY FEATURES

- GBBL Dielectric Yields High Volumetric Efficiency
- Stable Temperature Coefficient:  $\pm 15\%$  Max (-55°C to 125°C)
- Reduced Microphonics
- Offered With or Without Borders
- Thin Film TiW/Au or TiW/Ni/Au Electrodes

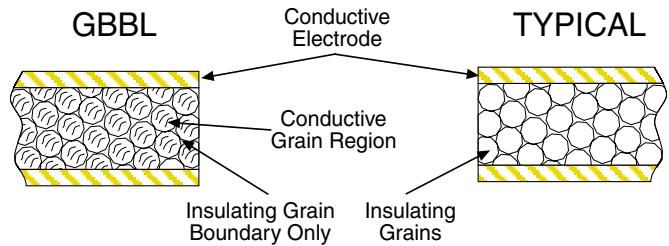

Johanson Technology's new "GBBL" microwave capacitor features high capacitance per case size without sacrificing the temperature stability associated with high dielectric constant materials. GBBL capacitors feature a proprietary X7R composition which is manufactured by a two step, atmospheric controlled sintering process. The resulting microstructure is composed of a conducting titanate ceramic grain in contact with an insulating Grain Boundary Layer (GBBL). The insulating boundary layer acts as a very thin dielectric. The process control of the boundary thickness, in conjunction with the conductive grain size, provides the cumulative effect of a very high, yet stable, dielectric constant.

## DIELECTRIC CHARACTERISTICS

**TEMPERATURE COEFFICIENT:**  $\pm 15\%$ , -55 to 125°C  
**VOLTAGE RATING:** 16 - 50 VDC  
**DISSIPATION FACTOR:** .025 (2.5%) max  
**AVAILABLE CAPACITANCE:** 68 pF - 0.01  $\mu$ F

**DIELECTRIC STRENGTH:** 2.5 X WVDC Min., 50 mA max  
**TEST PARAMETERS:** 1kHz  $\pm 50$ Hz, 1.0 $\pm 0.2$  VRMS, 25°C  
**INSULATION RESISTANCE:** 10,000 M $\Omega$  Typ.

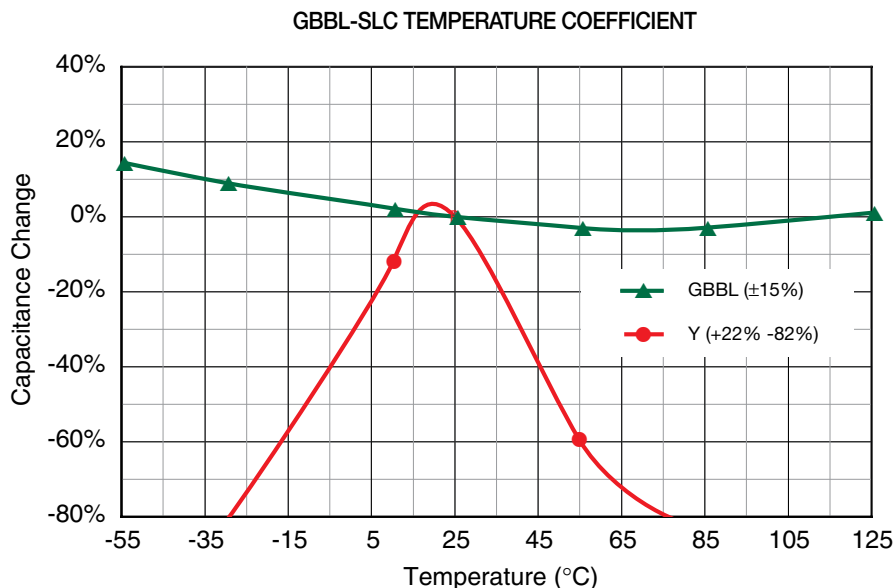

## SIZE & CAPACITANCE SELECTION

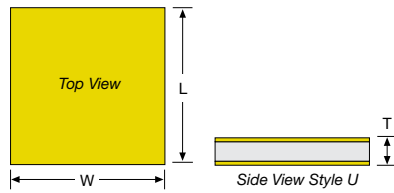

Border Style "U" Configuration

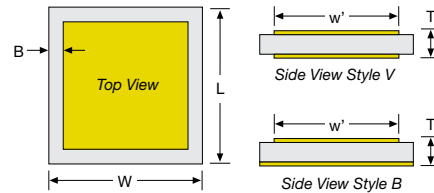

Border Style "V" & "B" Configuration

BORDER	U	V, B	U	V, B	U	V, B	U	V, B	U	V, B	U	V, B	
SIZE	01		02		03		04		05		06		
<b>W</b>	In (mm)	.015 ± .005 (0.38 ± .13)	.025 ± .005 (0.64 ± .13)	.035 ± .005 (0.89 ± .13)	.050 ± .010 (1.27 ± .25)	.070 ± .010 (1.78 ± .25)	.090 ± .010 (2.29 ± .25)						
<b>L</b>	In (mm)	.015 ± .005 (0.38 ± .13)	.025 ± .005 (0.64 ± .13)	.035 ± .005 (0.89 ± .13)	.050 ± .010 (1.27 ± .25)	.070 ± .010 (1.78 ± .25)	.090 ± .010 (2.29 ± .25)						
<b>T</b>	In (mm)	.007 ± .002 (0.18 ± .05)	.007 ± .002 (0.18 ± .05)	.007 ± .002 (0.18 ± .05)	.007 ± .002 (0.18 ± .05)	.007 ± .002 (0.18 ± .05)	.007 ± .002 (0.18 ± .05)						
<b>B</b>	In (mm)	n/a	.002±.001" (0.05±.03)	n/a	.002±.001" (0.05±.03)	n/a	.002±.001" (0.05±.03)	n/a	.002±.001" (0.05±.03)	n/a	.002±.001" (0.05±.03)	n/a	.002±.001" (0.05±.03)
<b>Capacitance pF</b>	<b>Code</b>	U01	V01 B01	U02	V02 B02	U03	V03 B03	U04	V04 B04	U05	V05 B05	U06	V06 B06
75	750	50V	50V										
82	820	50V	50V										
100	101	50V	50V										
120	121	50V	50V										
150	151	50V	50V										
220	221	25V	25V										
270	271	25V	16V		50V								
330	331	16V	16V	50V	50V								
390	391	16V	16V	50V	50V								
470	471	16V		50V	25V								
560	561			25V	25V								
680	681			25V	16V		50V						
750	751			16V	16V	50V	50V						
820	821			16V	16V	50V	25V						
1000	102			16V	16V	25V	25V						
1200	122			16V		25V	16V		50V				
1500	152					16V	16V	50V	50V				
1800	182					16V	16V	50V	25V				
2200	222					16V		25V	25V		50V		
2700	272							25V	16V	50V	50V		
3300	332							16V	16V	50V	25V		
3900	392							16V		25V	25V		50V
4700	472									25V	16V	50V	50V
5600	562									16V	16V	50V	25V
6300	632									16V		25V	25V
7500	752											16V	16V
8200	822											16V	16V
.01	103											16V	

## HOW TO ORDER GBBL-SLCs

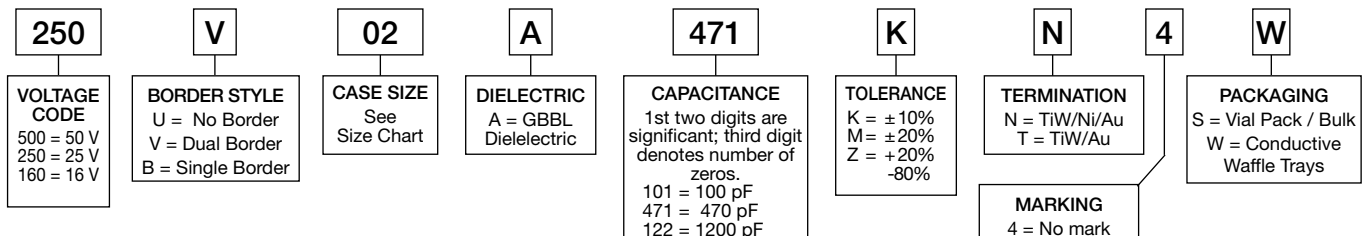

# SLC MICROWAVE / MILLIMETERWAVE CAPACITORS

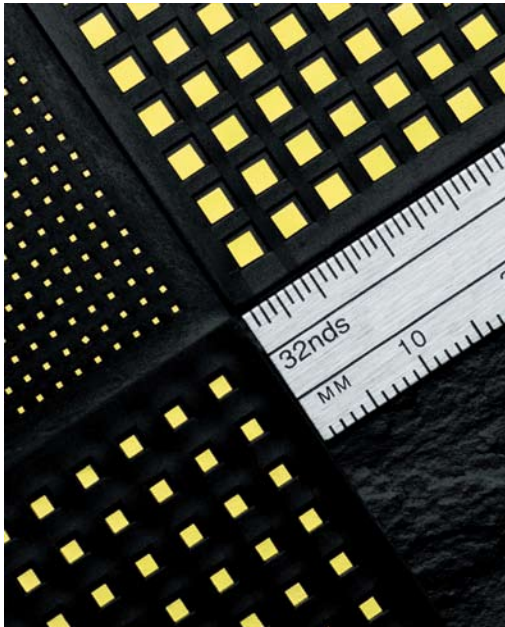

## KEY FEATURES

- Ceramic SLC Low Profile Devices Exhibit Very High-Q / Low Insertion Loss, SRFs to 50 GHz
- Thin Film Gold Electrodes Provide Superior Wire Bonding & Die Attach Performance
- Four SLC Device Types to Fit Many Applications:
 

Standard (Die) SLCs	Border SLCs
Bar SLC Arrays	Custom SLC Products

## APPLICATIONS

- Microwave Integrated Components
- GaAs Integrated Circuits
- RF/Microwave Components
- DC Block, Bypass, Tuning

## DIELECTRIC CHARACTERISTICS

DIELECTRIC CODE	CONSTANT (K)	TEMPERATURE COEFFICIENT	TEMPERATURE RANGE	DISSIPATION FACTOR / FREQ.	INSULATION RESISTANCE	TEST COND.	AVAILABLE TOLERANCES
C	23	0 ± 30 ppm	-55°C to +125°C	< 0.15%/1MHz	> 1000 GΩ	1	B,C,D (A, <2pF)
K	37	0 ± 30 ppm	-55°C to +125°C	< 0.15%/1MHz	> 1000 GΩ	1	B,C,D (A, <2pF)
N	80	0 ± 30 ppm	-55°C to +125°C	< 0.15%/1MHz	> 1000 GΩ	1	B,C,D (A, <2pF) (F - K, >10 pF)
U	120	-750 ± 120 ppm	-55°C to +125°C	< 0.25%/1MHz	> 1000 GΩ	1	J,K (B-D)
V	160	-1500 ± 300 ppm	-55°C to +125°C	< 0.25%/1MHz	> 1000 GΩ	1	J,K (B-D)
R	280	-2200 ± 500 ppm	-55°C to +125°C	< 0.25%/1MHz	> 1000 GΩ	1	J,K (B-D)
L	350	-3300 ± 500 ppm	-55°C to +125°C	< 1.50%/1MHz	> 1000 GΩ	1	J,K,M (B-D)
D	600	± 10%	-55°C to +125°C	< 2.50%/1KHz	> 100 GΩ	2	K,M
B	1200	± 10%	-55°C to +125°C	< 2.50%/1KHz	> 100 GΩ	2	K,M
W	2000	± 10%	-55°C to +125°C	< 2.50%/1KHz	> 100 GΩ	2	K,M
X	2700	± 10%	-55°C to +125°C	< 2.50%/1KHz	> 100 GΩ	2	K,M
T	4000	± 15%	-55°C to +125°C	< 2.50%/1KHz	> 100 GΩ	2	K,M
Z	8000	+22% -56%	+10°C to +85°C	< 4.00%/1KHz	> 10 GΩ	2	M,Z
Y	12000	+22% -82%	-30°C to +85°C	< 4.00%/1KHz	> 10 GΩ	2	M,Z

VOLTAGE RATINGS: 50 & 100 WVDC

DIELECTRIC STRENGTH: 2.5 x WVDC min, 25°C, 50 mA max

TEST CONDITIONS: 1) All Values: 1.0±0.2 VRMS @1MHZ, 25°C  
2) Values ≤100pF: Cond.1; Values >100pF: 1.0±0.2 VRMS @1KHZ, 25°C

## V-SERIES & B-SERIES BORDER SLC CAPACITORS

Recessed SLC electrode borders help prevent shorting from conductive epoxy squeeze-up and aid visual recognition equipment. The V-Series SLCs feature dual borders (top & bottom) while the B-Series SLCs feature a single border (top-only).

## V-SERIES & B-SERIES CAPACITANCE SELECTION

CAP. CODE	VALUE	V10 100V	V12 100V	V15 100V	V20 100V	V25 100V	V30 100V	V40 100V	V50 100V
0R1	0.1 pF	C	C	C					
0R2	0.2 pF	N	K	C	C				
0R3	0.3 pF	N	N	K	C	C			
0R4	0.4 pF	V	N	N	K	C			
0R5	0.5 pF	V	N	N	K	C	C		
0R6	0.6 pF	V	V	N	K	K	C		
0R7	0.7 pF	V	V	V	N	K	C		
0R8	0.8 pF	R	V	V	N	K	C		
0R9	0.9 pF	R	V	V	N	K	C	C	
1R0	1.0 pF	R	V	V	N	K	K	C	
1R1	1.1 pF	R	R	V	N	N	K	C	
1R2	1.2 pF	L	R	V	N	N	K	C	
1R3	1.3 pF	L	R	R	N	N	K	C	
1R4	1.4 pF	L	R	R	N	N	K	C	C
1R5	1.5 pF	L	R	R	V	N	K	C	C
1R6	1.6 pF	D	R	R	V	N	K	K	C
1R7	1.7 pF	D	R	R	V	N	K	K	C
1R8	1.8 pF	D	L	R	V	N	K	K	C
1R9	1.9 pF	D	L	L	V	N	N	K	C
2R0	2.0 pF	D	L	L	V	N	N	K	C
2R1	2.1 pF	D	L	L	V	N	N	K	C
2R2	2.2 pF	D	L	L	V	V	N	K	C
2R4	2.4 pF	D	L	L	V	V	N	K	K
2R7	2.7 pF	D	D	L	V	V	N	K	K
3R0	3.0 pF	B	D	D	L	V	N	K	K
3R3	3.3 pF	B	D	D	L	V	N	N	K
3R6	3.6 pF	B	D	D	L	V	N	N	K
3R9	3.9 pF	B	D	D	L	V	V	N	K
4R3	4.3 pF	B	D	D	L	R	V	N	K
4R7	4.7 pF	B	B	D	L	R	V	N	K
5R1	5.1 pF	B	B	D	L	R	V	N	K
5R6	5.6 pF	B	B	D	L	R	V	N	N
6R2	6.2 pF	W	B	B	D	R	V	V	N
6R8	6.8 pF	W	B	B	D	R	V	V	N

CAP. CODE	VALUE	V10 100V	V12 100V	V15 100V	V20 100V	V25 100V	V30 100V	V40 100V	V50 100V
6R8	6.8 pF	W	B	B	D	R	V	V	N
7R5	7.5 pF	W	B	B	D	L	R	V	N
8R2	8.2 pF	W	W	B	D	L	R	V	N
9R1	9.1 pF	W	W	B	D	D	R	V	N
100	10 pF	X	W	W	D	D	L	V	V
120	12 pF	X	W	W	B	D	L	R	V
150	15 pF	T	X	W	B	D	L	R	V
180	18 pF	T	X	X	B	D	D	R	R
200	20 pF	T	T	X	B	B	D	L	R
220	22 pF	Z	T	X	B	B	D	L	R
270	27 pF	Z	T	T	W	B	D	D	L
330	33 pF	Y	Z	T	W	B	B	D	L
390	39 pF	Y	Z	Z	X	W	B	D	L
470	47 pF	Y	Z	Z	X	W	B	D	D
500	50 pF	Y	Y	Z	X	W	B	D	D
510	51 pF	Y	Y	Z	T	X	B	D	D
560	56 pF	Y	Y	Z	T	X	B	B	D
680	68 pF		Y	Y	T	X	W	B	D
820	82 pF		Y	Y	Z	T	W	B	D
101	100 pF			Y	Z	T	X	W	B
121	120 pF				Z	T	X	W	B
151	150 pF				Y	Z	T	X	W
181	180 pF				Y	Z	T	T	W
201	200 pF				Y	Z	T	T	X
221	220 pF				Y	Y	Z	T	X
271	270 pF					Y	Z	T	X
331	330 pF					Y	Y	Z	T
391	390 pF						Y	Z	T
471	470 pF						Y	Z	T
561	560 pF						Y	Y	Z
681	680 pF							Y	Z
821	820 pF								Y
102	1000 pF								Y
122	1200 pF								Y

Color breaks used to highlight changes in dielectric material, letters indicate the specific material.

## V-SERIES & B-SERIES MECHANICAL CHARACTERISTICS

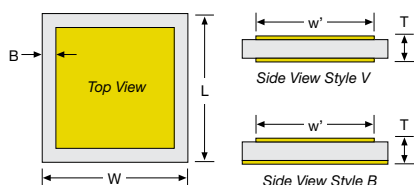

SIZE	V10	V12	V15	V20	V25	V30	V40	V50
<b>W&amp;L</b> ±.001" (mm)	.010 (0.25)	.012 (0.30)	.015 (0.38)	.020 (0.51)	.025 (0.64)	.030 (0.76)	.040 (1.02)	.050 (1.27)
<b>w'</b> NOM. (mm)	.008 (0.20)	.010 (0.25)	.011 (0.28)	.016 (0.41)	.020 (0.51)	.026 (0.66)	.036 (0.91)	.044 (1.12)
<b>B</b> ±.001" (mm)	.001* (0.025)*	.001* (0.025)*	.002 (0.051)	.002 (0.051)	.002 (0.051)	.002 (0.051)	.002 (0.051)	.003 (0.076)
<b>T</b> ±.001" (mm)	.006 (0.15)	.006 (0.15)	.006 (0.15)	.006 (0.15)	.006 (0.15)	.006 (0.15)	.006 (0.15)	.006 (0.15)

\*Min Border 0.0005" Contact factory for other sizes, values or configurations

# U-SERIES STANDARD SINGLE LAYER CAPACITORS

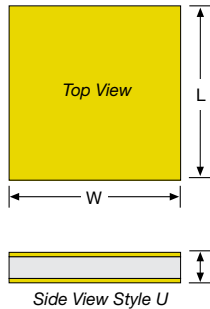

SIZE	U10	U12	U15	U20	U25	U30	U35	U50	U70	U90
<b>W</b> $\pm .001''$ (mm) $-.003''$	.010 (0.25)	.012 (0.30)	.015 (0.38)	.020 (0.51)	.025 (0.64)	.030 (0.76)	.035 (0.89)	.050 (1.27)	.070 (1.78)	.090 (2.29)
<b>L</b> MAX. (mm)	.010 (0.25)	.015 (0.38)	.020 (0.51)	.020 (0.51)	.030 (0.76)	.030 (0.76)	.040 (1.02)	.060 (1.52)	.080 (2.03)	.100 (2.54)
<b>T(50V)</b> $\pm .001''$ (mm)	.004 (0.10)	.004 (0.10)	.004 (0.10)	.004 (0.10)	.004 (0.10)	.004 (0.10)	.004 (0.10)	.004 (0.10)	.004 (0.10)	.004 (0.10)
<b>T(100V)</b> $\pm .001''$ (mm)	.006 (0.15)	.006 (0.15)	.006 (0.15)	.006 (0.15)	.006 (0.15)	.006 (0.15)	.006 (0.15)	.006 (0.15)	.006 (0.15)	.006 (0.15)

Contact factory for other sizes, values or configurations

CAPACITANCE	U10	U12	U15		U20		U25		U30		U35		U50	U70	U90	CAPACITANCE		
CODE	VALUE	50V	50V	50V	100V	50V	100V	50V	100V	50V	100V	50V	100V	100V	100V	100V	CODE	VALUE
0R1	0.1 pF	C															0R1	0.1 pF
0R2	0.2 pF	K	C		C												0R2	0.2 pF
0R3	0.3 pF	N	K	C	K			C									0R3	0.3 pF
0R4	0.4 pF	N	N	K	K	C	C		C								0R4	0.4 pF
0R5	0.5 pF	U	N	K	N	C	K		C								0R5	0.5 pF
0R6	0.6 pF	V	N	K	N	C	K	C	C			C					0R6	0.6 pF
0R7	0.7 pF	V	N	N	N	K	K	C	K		C		C				0R7	0.7 pF
0R8	0.8 pF	V	U	N	N	K	N	C	K		C		C				0R8	0.8 pF
0R9	0.9 pF	R	V	N	U	K	N	C	K	C	C		C				0R9	0.9 pF
1R0	1.0 pF	R	V	N	U	K	N	K	K	C	K		C	C			1R0	1.0 pF
1R1	1.1 pF	R	V	N	V	K	N	K	K	C	K	C	C	C			1R1	1.1 pF
1R2	1.2 pF	R	V	N	V	N	N	K	N	C	K	C	C	C			1R2	1.2 pF
1R3	1.3 pF	R	V	N	V	N	N	K	N	C	K	C	K	C			1R3	1.3 pF
1R4	1.4 pF	L	V	U	V	N	N	K	N	K	K	C	K	C			1R4	1.4 pF
1R5	1.5 pF	L	V	U	V	N	N	K	N	K	K	C	K	C			1R5	1.5 pF
1R6	1.6 pF	L	R	U	V	N	U	K	N	K	N	C	K	C			1R6	1.6 pF
1R7	1.7 pF	L	R	U	V	N	U	K	N	K	N	C	K	C			1R7	1.7 pF
1R8	1.8 pF	L	R	U	R	N	U	N	N	K	N	C	K	C			1R8	1.8 pF
1R9	1.9 pF	L	R	V	R	N	U	N	N	K	N	K	K	C			1R9	1.9 pF
2R0	2.0 pF	D	R	V	R	N	U	N	N	K	N	K	K	K			2R0	2.0 pF
2R1	2.1 pF	D	L	V	R	N	V	N	N	K	N	K	K	K	C		2R1	2.1 pF
2R2	2.2 pF	D	L	V	R	U	V	N	U	K	N	K	N	K	C		2R2	2.2 pF
2R4	2.4 pF	D	L	V	R	U	V	N	U	K	N	K	N	K	C		2R4	2.4 pF
2R7	2.7 pF	D	L	R	L	U	V	N	U	N	N	K	N	K	C	C	2R7	2.7 pF
3R0	3.0 pF	D	L	R	L	U	V	N	U	N	N	K	N	K	C	C	3R0	3.0 pF
3R3	3.3 pF	D	L	R	L	V	R	N	V	N	U	K	N	K	C	C	3R3	3.3 pF
3R6	3.6 pF	D	D	R	L	V	R	U	V	N	U	K	N	K	C	C	3R6	3.6 pF
3R9	3.9 pF	B	D	R	L	V	R	U	V	N	U	N	N	N	C	C	3R9	3.9 pF
4R3	4.3 pF	B	D	R	D	V	R	U	V	N	V	N	N	N	C	C	4R3	4.3 pF
4R7	4.7 pF	B	D	L	D	R	R	U	R	N	V	N	N	N	K	C	4R7	4.7 pF
5R1	5.1 pF	B	D	L	D	R	R	V	R	U	V	N	U	N	K	C	5R1	5.1 pF
5R6	5.6 pF	B	D	L	D	R	L	V	R	U	V	N	U	N	K	K	5R6	5.6 pF
6R2	6.2 pF	B	D	D	D	R	L	V	R	U	V	N	V	N	K	K	6R2	6.2 pF
6R8	6.8 pF	B	B	D	D	R	L	R	R	V	R	N	V	N	K	K	6R8	6.8 pF
7R5	7.5 pF	W	B	D	D	R	D	R	L	V	R	U	V	N	K	K	7R5	7.5 pF
8R2	8.2 pF	W	B	D	B	L	D	R	L	V	R	U	V	N	N	K	8R2	8.2 pF
9R1	9.1 pF	W	B	D	B	L	D	R	L	V	R	U	R	N	N	N	9R1	9.1 pF
100	10 pF	X	B	D	B	L	D	R	L	R	L	V	R	V	N	N	100	10 pF

Color breaks used to highlight changes in dielectric material, letters indicate the specific material

## U SERIES SLC CAPACITANCE SELECTION (CONT.)

CAPACITANCE		U10		U12		U15		U20		U25		U30		U35		U50		U70		U90		CAPACITANCE	
CODE	VALUE	50V	50V	50V	100 V	50V	100 V	50V	100 V	50V	100 V	50V	100V	50V	100V	100V	100V	100V	100V	100V	100V	CODE	VALUE
100	10 pF	X	B	D	B	L	D	R	L	R	L	V	R	V	N	N	100	10 pF					
120	12 pF	X	W	B	B	D	D	L	D	R	L	V	R	V	N	N	120	12 pF					
150	15 pF	T	W	B	W	D	B	L	D	R	L	R	L	V	N	N	150	15 pF					
180	18 pF	T	W	B	W	D	B	D	D	L	D	R	L	V	V	N	180	18 pF					
200	20 pF	T	X	W	W	D	B	D	D	L	D	R	D	R	V	N	200	20 pF					
220	22 pF	T	X	W	X	B	B	D	B	L	D	R	D	R	V	N	220	22 pF					
270	27 pF	Z	T	W	X	B	W	D	B	D	L	D	R	V	U	U	270	27 pF					
330	33 pF	Z	T	X	T	B	W	B	B	D	B	L	D	L	R	U	330	33 pF					
390	39 pF	Z	T	X	T	W	X	B	W	D	B	D	B	L	R	V	390	39 pF					
470	47 pF	Y	Z	T	T	W	X	B	W	D	B	D	B	D	R	V	470	47 pF					
500	50 pF	Y	Z	T	Z	W	X	B	W	B	B	D	B	D	R	V	500	50 pF					
510	51 pF	Y	Z	T	Z	W	X	B	W	B	B	D	B	D	R	V	510	51 pF					
560	56 pF	Y	Z	T	Z	X	T	B	X	B	W	D	B	D	R	R	560	56 pF					
680	68 pF		Z	Z	Z	X	T	W	X	B	W	B	W	D	L	R	680	68 pF					
820	82 pF		Y	Z	Y	T	Z	W	T	B	X	B	X	B	D	R	820	82 pF					
101	100 pF		Y	Z	Y	T	Z	X	T	W	X	B	X	B	D	L	101	100 pF					
121	120 pF			Y	Y	T	Z	T	T	W	X	T	W	X	B	D	121	120 pF					
151	150 pF			Y		Z	Y	T	Z	X	T	W	X	B	B	D	151	150 pF					
181	180 pF			Y		Z	Y	T	Z	T	T	W	T	W	B	D	181	180 pF					
201	200 pF					Z	Y	Z	Z	T	Z	X	T	W	B	B	201	200 pF					
221	220 pF					Y	Y	Z	Z	T	Z	X	T	W	B	B	221	220 pF					
271	270 pF					Y		Z	Y	T	Z	T	Z	X	W	B	271	270 pF					
331	330 pF					Y		Y	Y	Z	Z	T	Z	X	W	W	331	330 pF					
391	390 pF							Y		Z	Y	T	Z	T	X	W	391	390 pF					
471	470 pF							Y		Z	Y	Z	Y	T	X	W	471	470 pF					
561	560 pF							Y		Y		Z	Y	T	T	X	561	560 pF					
681	680 pF									Y		Z	Y	Z	T	X	681	680 pF					
821	820 pF											Y		Z	T	X	821	820 pF					
102	1000 pF											Y		Z	T	T	102	1000 pF					
122	1200 pF													Y	Z	T	122	1200 pF					
152	1500 pF													Y	Y	Z	152	1500 pF					
182	1800 pF														Y	Z	182	1800 pF					
202	2000 pF														Y	Z	202	2000 pF					
252	2500 pF														Y	Y	252	2500 pF					
402	4000 pF															Y	402	4000 pF					

Color breaks used to highlight changes in dielectric material, letters indicate the specific material

## HOW TO ORDER U, V, & B SERIES

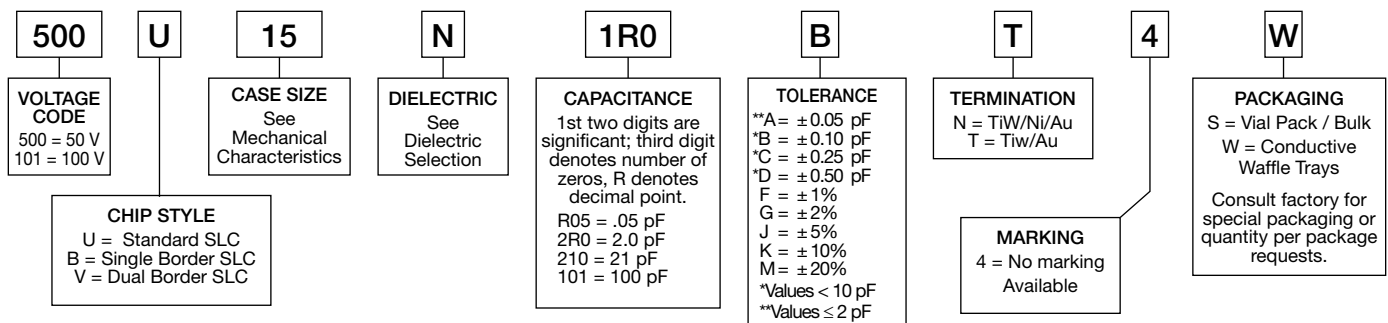

NOTE: The "U" series thick-film terminated SLC's are fully supported and orders may be placed using legacy part numbers. These parts are identified by alpha case size code and contain termination codes "G" or "9" i.e. 500UDB200JG4W.



## SLC TEMPERATURE CHARACTERISTICS

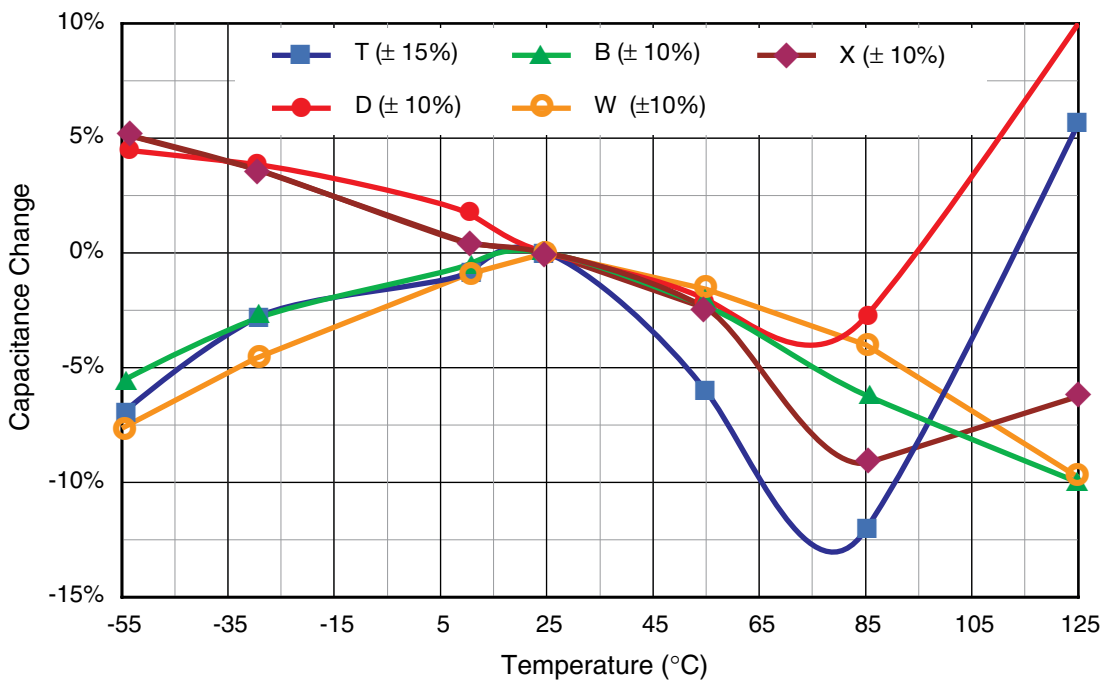
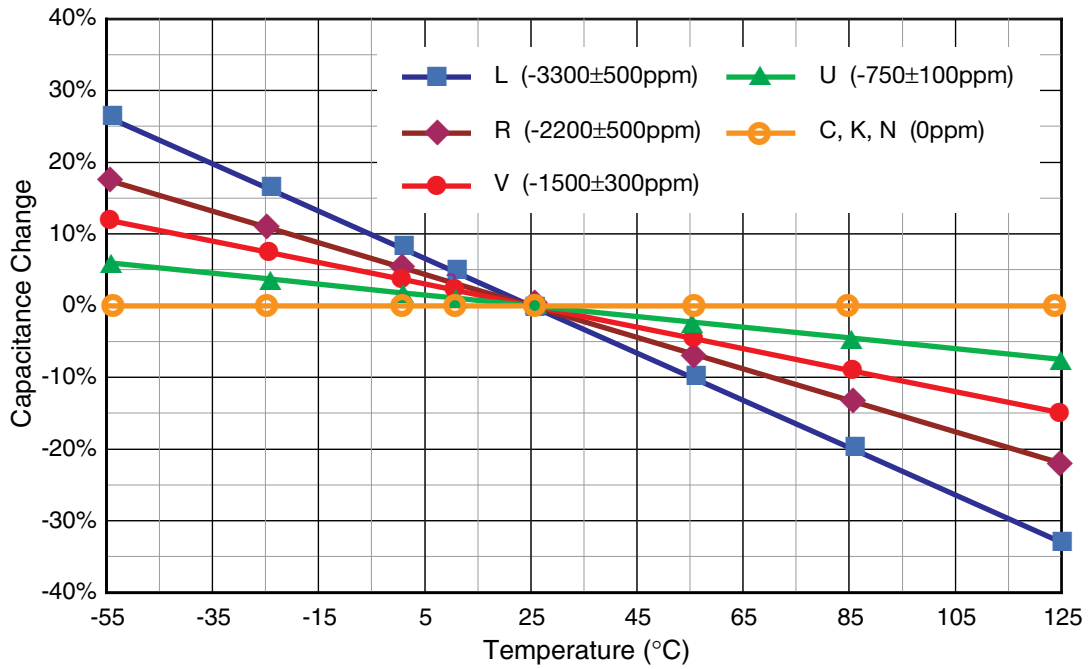

## SLC TEMPERATURE CHARACTERISTICS

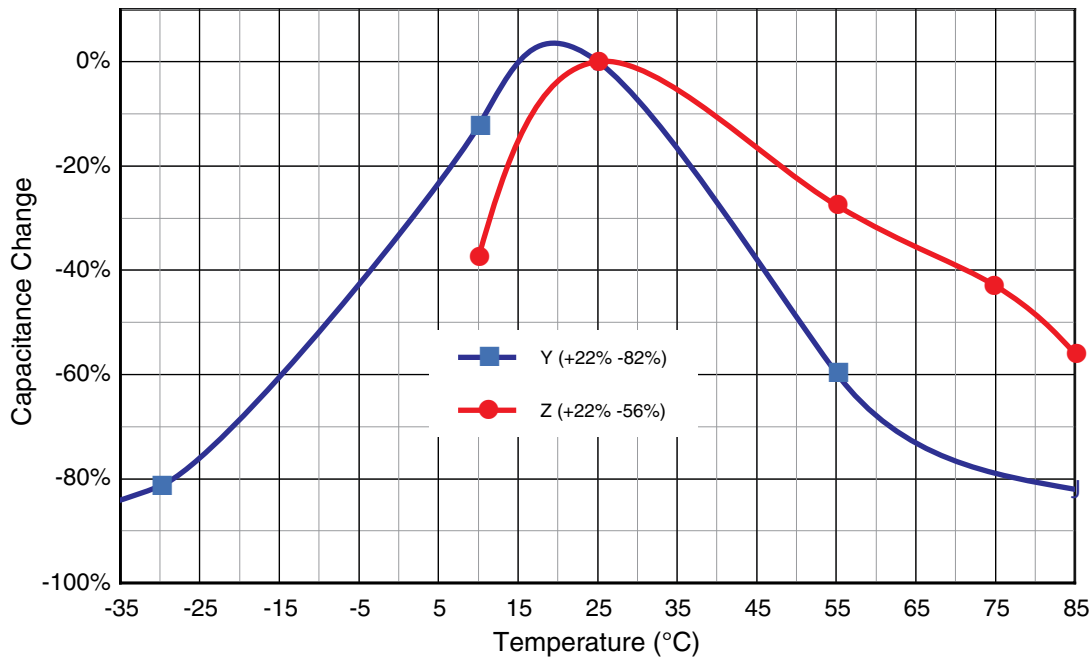

## METALIZATION CHARACTERISTICS

<b>METALIZATION TYPE</b>	TiW/Au (Titanium-Tungsten/Gold)	TiW/Ni/Au (Titanium-Tungsten/Nickel/Gold)
<b>TERMINATION CODE</b>	T	N
<b>ATTACHMENT COMPATIBILITY</b>	Wire / Ribbon Bonding Silver or Gold Conductive Epoxy Au/Ge or Au/Si Eutectic Preform Excellent High Temperature Resistance (400°C) Unsuitable for Pb/Sn or Au/Sn Soldering	Pb/Sn or Au/Sn Soldering Au/Sn Eutectic Preform Moderate High Temp. Resistance (325°C) Long term high temperature may cause Ni diffusion and wire bond problems on Au/Ge

SLC thick-film terminations ( legacy codes “G” and “9”) are still supported. Contact the factory for compatibility information.

## ENVIRONMENTAL CHARACTERISTICS

<b>BOND STRENGTH:</b>	Exceeds MIL-S-883, Meth. 2011	<b>VIBRATION:</b> MIL-S-202, Meth. 204-G, (30g, 10-2000 Hz)
<b>SHEAR STRENGTH:</b>	Exceeds MIL-S-883, Meth. 2019	<b>BURN-IN/LIFE TEST:</b> MIL-S-202, Meth. 108, A/F
<b>SOLDER HEAT RESISTANCE:</b> MIL-S-202, Meth. 210-C, (260±5°C, 5 sec.)		<b>LOW VOLTAGE HUMIDITY:</b> Mil-C-49464, Para. 3.17
<b>SOLDERABILITY:</b> MIL-S-202, Meth. 208, (245±5°C, 5 sec.)		<b>BAROMETRIC PRESSURE:</b> MIL-S-202, Meth. 105, B
<b>SHOCK:</b> MIL-S-202, Meth. 213-I, (100g, 6 msec.)		<b>IMMERSION/SALT SPRAY:</b> MIL-S-202, Meth. 104, B
<b>THERMAL SHOCK:</b> MIL-S-202, Meth. 107, A, (-55 to +125°C)		<b>MOISTURE RESISTANCE:</b> MIL-S-202, Meth. 106

## CUSTOM SUBSTRATES & THIN FILM PRODUCTS



Metalized substrates may also be patterned to customer specifications by chemical etching, abrasive etching, or pattern plating. Please contact the factory for other types of metallization configurations other than a continuous top / bottom plating. Other termination material thicknesses are available upon request.

Johanson Technology offers a wide range of dielectrics for use in application specific environments. These materials are available both lapped and “as fired” condition as well as metalized and non-metalized substrates. Standard substrate sizes range from 0.50” x 0.50” to 1.50” x 1.50”, with larger sizes available with special order . Dielectrics are available from 0.005” to 0.050” thick.

METALLIZATION	CODE
TiW / Au	T
TiW / Ni / Au	N
TiW / Ni / Sn	V
TaN / TiW / Au	R
TiW / Ni / Cu / Ni / Au	C
80Au / 20 Sn	E
Non-Metallized	X

**Note: When metallization is requested on both top and bottom sides, the metallization will wrap around the sides as a standard unless otherwise specified.**

SUBSTRATE MATERIAL	MATERIAL CODE	K	TEMPERATURE COEFFICIENT	OPERATING TEMPERATURE	DISSIPATION FACTOR
ALN *	F	8.8	170 W/M deg K (Th. Cond.)	-55 to +125 deg. C	
Alumina *	G	9.9	P120 +/- 30 ppm / deg C	-55 to +125 deg. C	
Titanate Based	C	23	0 +/- 30 ppm / deg C	-55 to +125 deg. C	< 0.15% @ 1 MHz
Titanate Based	K	37	0 +/- 30 ppm / deg C	-55 to +125 deg. C	< 0.15% @ 1 MHz
Titanate Based	N	80	0 +/- 30 ppm / deg C	-55 to +125 deg. C	< 0.15% @ 1 MHz
Titanate Based	U	120	-750 +/- 120 ppm / deg C	-55 to +125 deg. C	< 0.25% @ 1 MHz
Titanate Based	V	160	-1500 +/- 300 ppm / deg C	-55 to +125 deg. C	< 0.25% @ 1 MHz
Titanate Based	R	280	-750 +/- 120 ppm / deg C	-55 to +125 deg. C	< 0.25% @ 1 MHz
Titanate Based	L	350	-750 +/- 120 ppm / deg C	-55 to +125 deg. C	< 1.50% @ 1 MHz
Titanate Based	D	600	+/- 10% (-55 to +125 C)	-55 to +125 deg. C	< 2.50% @ 1 kHz
Titanate Based	B	1200	+/- 10% (-55 to +125 C)	-55 to +125 deg. C	< 2.50% @ 1 kHz
Titanate Based	W	2000	+/- 10% (-55 to +125 C)	-55 to +125 deg. C	< 2.50% @ 1 kHz
Titanate Based	X	2700	+/- 15% (-55 to +125 C)	-55 to +125 deg. C	< 2.50% @ 1 kHz
Titanate Based	T	4000	+/- 15% (-55 to +125 C)	-55 to +125 deg. C	< 2.50% @ 1 kHz
Titanate Based	Z	8000	+22/-56% (+10 to +85 C)	-55 to +125 deg. C	< 4.00% @ 1 kHz
Titanate Based	Y	12000	+22/-82% (-30 to +85 C)	-55 to +125 deg. C	< 4.00% @ 1 kHz

\* All of the bare substrates are made from the raw powders at JTI except for the Alumina Nitride and Alumina substrates which are purchased and value added at JTI by sputtering on metallization per customer specification

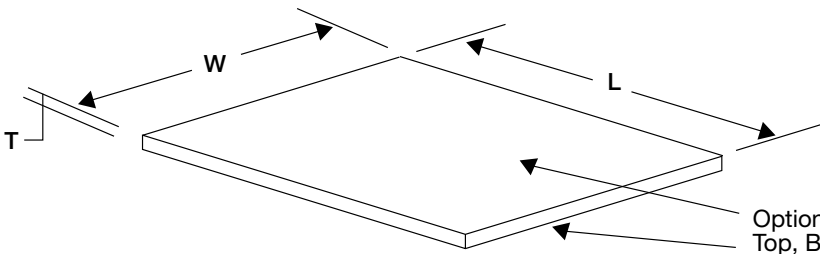
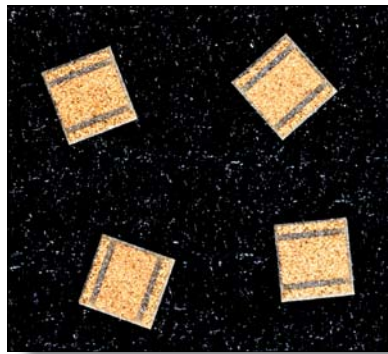
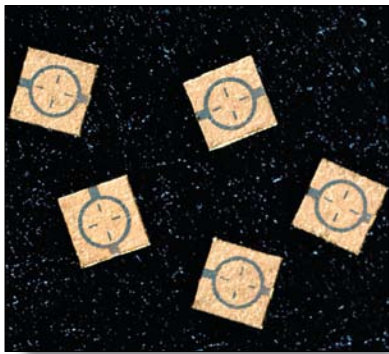

FLATNESS (Standard): 1 mil per 100 mils. Please contact the factory for other flatness options.

NOTE: The thickness specified in the JTI part number is the thickness of the dielectric material not including the termination materials.

NOTE: The standard thickness of the Nickel barrier (if used) is 10 - 20 microinches (for non-bordered parts) and is 20 - 50 microinches (for bordered parts), and the thickness of the Gold is 100 microinches minimum. Other termination material thicknesses are available upon request.

## HOW TO ORDER

<b>500</b>	<b>M</b>	<b>12</b>	<b>T</b>	<b>045</b>	<b>K</b>	<b>G</b>	<b>S</b>	<b>R</b>	<b>-</b>	<b>T</b>	<b>***</b>	<b>-</b>	<b>AA</b>
<p><b>VOLTAGE CODE</b> 1st two digits are significant; third digit denotes number of zeros, R denotes decimal point.</p> <p>6R0 = 6VDCW 250 = 25 VDCW 101 = 100 VDCW 501 = 500 VDCW 102 = 1000 VDCW 502 = 5000 VDCW</p>	<p><b>PART TYPE</b> M = Substrate</p>	<p><b>DIELECTRIC CODE</b> A = NPO/COG B = BX/X7R C = NPO D = BX F = ALUMINUM/NITRIDE G = ALUMINA K = NPO L = NEG TC N = NPO Q = P90/Hi Q R = NEG TC T = X7R U = NEG TC V = NEG TC W = X7R X = X7R Y = Y5V Z = Z5U</p>	<p><b>THICKNESS CODE</b> Thickness in mils 3rd digit is the decimal point</p> <p>eg: 050 = 5.0 mils eg: 065 = 6.5 mils eg: 128 = 12.8 mils</p>	<p><b>GS = Back side metallization code</b> X = Underminated 9 = Thick film G = Thick film + Au H = Thick film + Ni-Au T = Thin Film TiW-AU N = Thin Film TiW-NI-AU R = TaN-TiW-Au V = TiW-Ni-Sn E = 80Au/20Sn C = TiW-Ni-Cu-Ni-Au S = Special</p>	<p><b>METALIZATION</b> A or Blank = Not applicable S = Seed layer gold only P = 100 micro" min. std X = Special</p> <p>Use blank in the S column instead of "A" only if it the last character in the part#</p>	<p><b>THICKNESS TOLERANCE CODE</b> A = ±.05 mil B = ±1.0 mil C = ±2.0 mil</p> <p>J = ±5.0 % K = ±10.0 % L = ±15.0 % M = ±20.0 % X = Special</p>	<p><b>RT = Top side metallization code</b> X = Underminated 9 = Thick film G = Thick film + Au H = Thick film + Ni-Au T = Thin Film TiW-AU N = Thin Film TiW-NI-AU R = TaN-TiW-Au V = TiW-Ni-Sn E = 80Au/20Sn C = TiW-Ni-Cu-Ni-Au S = Special Blank = Both Sides are the Same</p>	<p><b>METALIZATION</b> A or Blank = Not applicable S = Seed layer gold only P = 100 micro" min. std X = Special</p> <p>Leave R and T blank if both sides have the same type metallization.</p> <p>If metallization types are different, then back side is scribed with an X.</p>	<p><b>NON-STANDARD CODE</b> Defines non-standard product marking, leading, testing, dielectric, cust. code, non-std. thk., L, W, endband &amp; size codes, etc...</p>	<p><b>*** - ASTERISK</b> Required (place holders)</p>	<p><b>AA</b></p>		



# APPLICATION NOTES FOR CERAMIC CHIP CAPACITORS

## GENERAL

Ceramic chip capacitors exhibit excellent reliability characteristics providing that proper circuit design techniques and controlled assembly processes are utilized. Due to the ceramic capacitor's crystalline micro-structure these components are susceptible when exposed to excessive thermal or mechanical shock during circuit processing. It should be noted that micro-cracks in ceramic can be difficult to detect with normal post assembly visual and electrical testing and can pose a significant threat to reliable field operation. For this reason it is recommended that the assembly qualification process employ suitable testing to expose the presence of micro-cracking conditions.

## CHIP CAPACITOR ATTACHMENT

LASERtrim® CAPACITORS - Offered with gold flashed nickel-barrier terminations only. Due to the unique internal construction of the LASERtrim® it is recommended that a conservative reflow temperature profile be used ( Fig. 1). Wave soldering is discouraged.

HIGH FREQUENCY CAPACITORS & INDUCTORS - Offered with standard tin plated nickel-barrier terminations compatible with solder flow and reflow processes.

MICROWAVE SINGLE LAYER CAPACITORS - Offered with Titanium-Tungsten/Gold and Titanium-Tungsten/Nickel/Gold thin-film termination as well as legacy Platinum/Palladium/Gold terminations. Please refer to the attachment compatibility table (page 31) specific to these devices.

## SOLDERING IRON

Ceramic capacitor attachment with a soldering iron is discouraged due to the inherent limitations on precisely controlling soldering temperature, heat transfer rate, and time. In the event that a soldering iron must be employed the following precautions are recommended.

- Preheat circuit and capacitors to 150°C
- Never contact the ceramic with the iron tip
- 30 watt iron output (max)
- 280°C tip temperature (max)
- 3.0 mm tip diameter (max)
- Limit soldering time to 5 sec.

## SOLDER PRE-HEAT CYCLE

Proper preheating is essential to prevent thermal shock cracking of the capacitor. The circuit assembly should be preheated as shown in the recommended profiles at a rate of 1.0 to 2.0°C per second to within 65 to 100°C of the maximum soldering temperature.

## SMT SOLDERING TEMPERATURES

Solders typically utilized in SMT have melting points between 179°C and 188°C. Activation of rosin fluxes occurs at about 200°C. Based on these facts a minimum peak reflow temperature of 205°C to 210°C should be established. A maximum peak reflow temperature of 225°C should be adequate in most circumstances. Many reflow process profiles have peaks ranging from 240°C to 260°C and while ceramic capacitors can withstand soldering temperatures in this range for short durations they should be minimized or avoided whenever possible. Use of PCB mounted multiple thermocouple M.O.L.E. profiling is advised for accurate characterization of circuit heat absorption and maximum temperature conditions.

## REFLOW SOLDER

The general term “reflow” refers to several methods used in heating the circuit so that solder paste reflows, or “wetting” of the ceramic capacitor and PCB contacts occurs. These methods include infra-red, convection and radiant heating. The size of the solder fillet may be controlled by varying the amount of solder paste that is screened onto the circuit. Recommended temperature limits for solder reflow are shown in Figure 1 for LASERtrim® and in Figure 2 for standard capacitors.

## VAPOR PHASE

A typical vapor phase soldering process consists of several temperature zones created by saturated vapor from a boiling liquid. As the circuit passes through the zone the vapor condenses on the solder paste, pad, and termination resulting in heat transfer and reflow of the solder paste. Vapor phase reflow produces consistent circuit heating with reflow occurring at a relatively lower temperature that is determined by the known boiling point of the liquid used, typically 215°C. Recommended temperature limits for vapor phase reflow are shown in Figure 3.

# APPLICATION NOTES FOR CERAMIC CHIP CAPACITORS

## SOLDER WAVE

Wave soldering is perhaps the most rigorous of surface mount soldering processes due to the steep rise in temperature seen by the circuit as it is immersed in the molten solder wave, typically at 240°C. Recommended temperature limits for wave soldering are shown in Fig. 4.

## COOL DOWN CYCLE

After the solder reflows properly the assembly should be allowed to cool gradually at room ambient conditions. Attempts to speed this cooling process or immediate exposure of the circuit to cold cleaning solutions may result in thermal shock cracking of the ceramic capacitor.

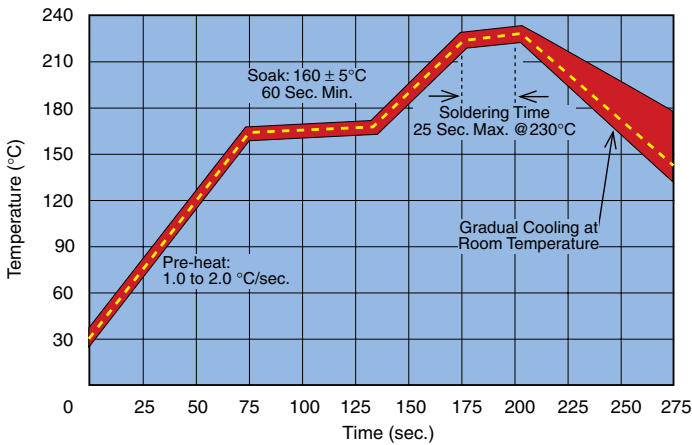

Figure 1: Solder Reflow Profile for LASERtrims®

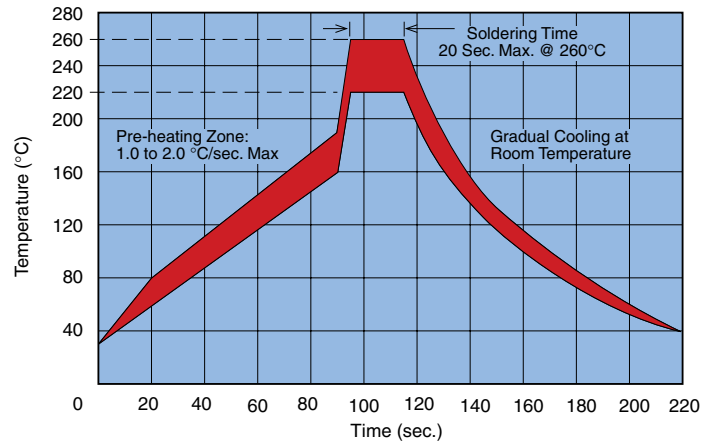

Figure 2: Solder Reflow Profile for MLCCs

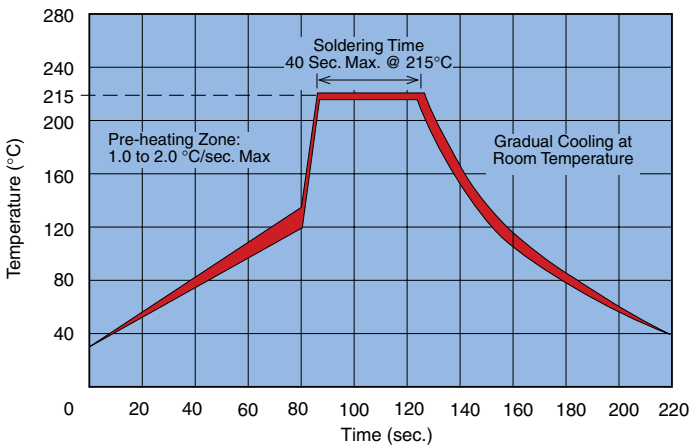

Figure 3: Vapor Phase Profile for MLCCs

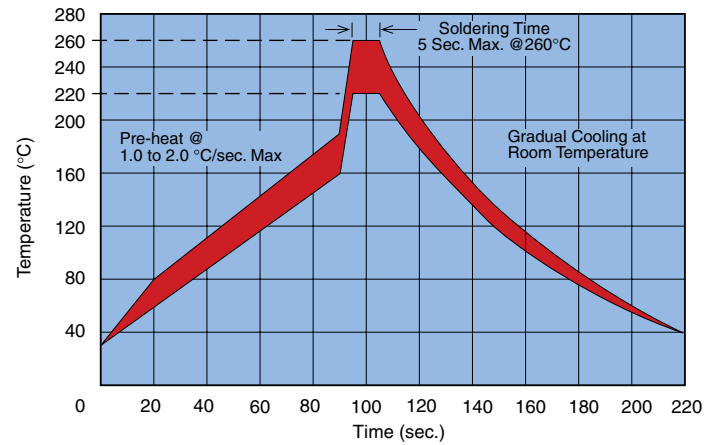

Figure 4: Wave Solder Profile for MLCCs

Please refer to our web site for solder profile information for other component types.

# APPLICATION NOTES FOR CERAMIC CHIP CAPACITORS

## BOARD LAYOUT & PAD DESIGN

Solder pad design, solder application, and component placement are important elements of the soldering process. Excessive transfer of thermal or mechanical stresses to the MLC can result from oversized solder fillets. Nominal pad designs for solder reflow process are listed in Table 1. These guidelines represent a starting point in Printed Circuit Board (PCB) design.

Further information is the Institute for Interconnecting and Packaging Electronic Circuits ([www.ipc.org](http://www.ipc.org)) has developed and published IPC-SM-782A "Surface Mount Design and Land Pattern Standard".

CHIP SIZE		(L) LENGTH		(S) SEPARATION		(W) WIDTH	
		min	max	min	max	min	max
0201	IN	0.008	0.014	0.008	0.012	0.008	0.016
0603	mm	0.20	0.35	0.20	0.30	0.20	0.40
0402	IN	0.014	0.018	0.012	0.020	0.016	0.024
1005	mm	0.35	0.45	0.30	0.50	0.40	0.60
0603	IN	0.024	0.028	0.024	0.031	0.024	0.031
1608	mm	0.60	0.70	0.60	0.80	0.60	0.80
0805	IN	0.024	0.028	0.039	0.047	0.031	0.043
2012	mm	0.60	0.70	1.00	1.20	0.80	1.10
1210	IN	0.039	0.047	0.079	0.094	0.071	0.091
3225	mm	1.00	1.20	2.00	2.40	1.80	2.30

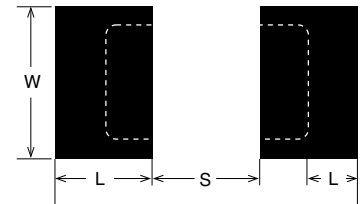
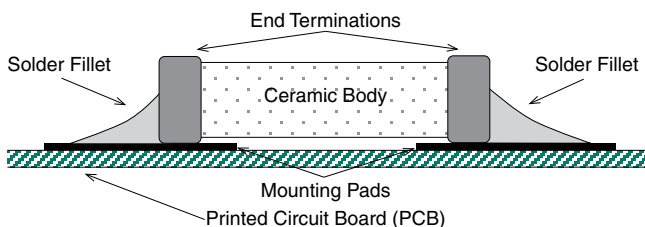

Table 1 Reflow Pad Dimensions

## SOLDER FILLETS

To avoid detrimental effects of thermal and mechanical stress it is essential that the solder fillet be limited to 2/3rds of the overall height of the MLC termination as illustrated in the figure below. The solder fillet can be controlled by solder paste deposition and pad design in reflow and vapor phase processes and by pad design and use of hot air knives in the wave process.



## TOMB STONING / CHIP MOVEMENT

Tomb-stoning or draw bridging is illustrated in the figure below. Tomb-stoning or other undesirable chip movements may result if unequal surface tension forces exist as the molten solder wets the MLC terminations and mounting pads. This tendency can be minimized by insuring that all factors at both solder joints are equal, namely; pad size, solder mass, termination size, component position and heating. Tomb-stoning is easily avoided through proper design, material selection and proofing of the process.

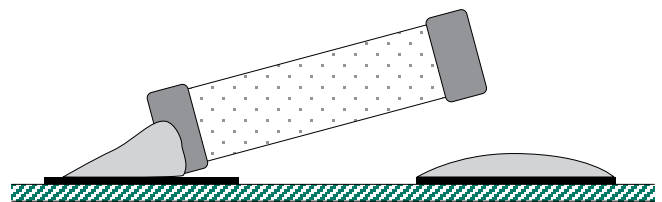

# CHIP TAPE & REEL PACKAGING



Johanson capacitors are available taped per EIA standard 481. Tape options include 5", 7" and 13" diameter reels. Johanson uses high quality, dust free, punched 8mm paper tape and plastic embossed 8mm tape for thicker MLCs. Quantity per reel ranges are listed in the tables below and are dependent on chip thickness.

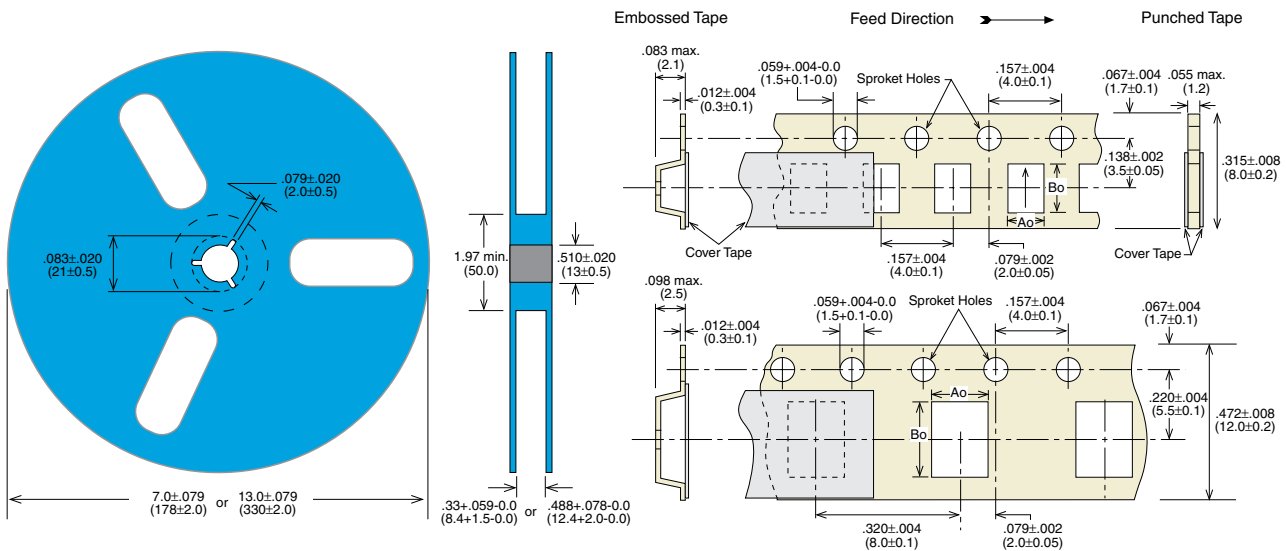

TYPE / SIZE	5" DIA. REEL SIZE			7" DIA. REEL SIZE			13" DIA. REEL SIZE		
	REEL QUANTITY	TAPE TYPE	TAPE CODE	REEL QUANTITY	TAPE TYPE	TAPE CODE	REEL QUANTITY	TAPE TYPE	TAPE CODE
R05 / 0201	500	Paper	Y	15,000	Paper	T	N/A	N/A	N/A
R07 / 0402	500	Paper	Y	10,000	Paper	T	N/A	N/A	N/A
R14 / 0603	500	Paper	Y	4,000	Paper	T	10,000	Paper	R
R15 / 0805	500	Embossed	Z	4,000	Embossed	E	10,000	Embossed	U
S42 / 1111	500	Embossed	Z	3,000	Embossed	E	10,000	Embossed	U
S48 / 2525	N/A			250	Embossed	E	1,000	Embossed	U
S58 / 3838	N/A			250	Embossed	E	1,000	Embossed	U
LASERtrim® (All)	500	Paper	Y	4.5-5.0K	Paper	T	15,000	Paper	R

SUBSTRATES - 100/TRAY

CAP ARRAYS - 100/TRAY

PLEASE VISIT OUR WEB SITE FOR RF CERAMIC COMPONENT PACKAGING INFORMATION.





**Packing Quantity**

TYPE	PCS / REEL
L-07	10,000
L-14	3,000
L-15	2,000

**Reel Dimensions**

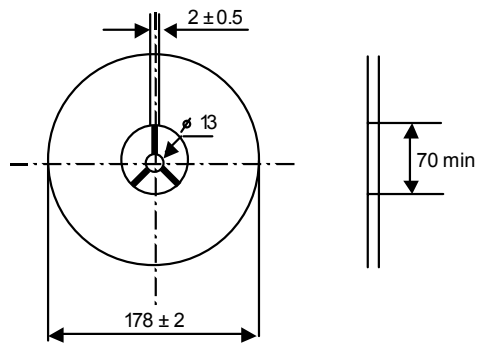

**Dimensions (unit: m/m)**

TYPE	A	B	T
L-07	0.70	1.20	0.70
L-14	1.25	1.80	1.20
L-15	1.42	2.26	1.40

**Tape Dimensions**

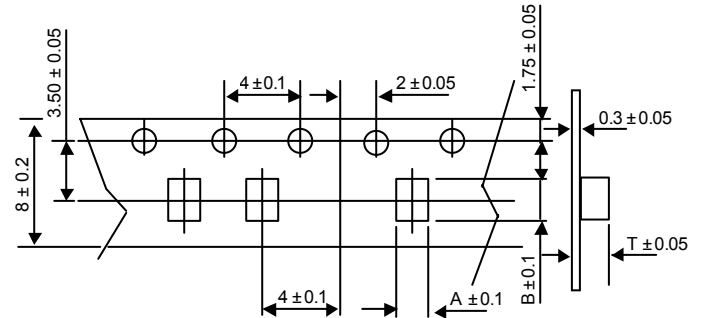

**Dimensions (unit: m/m)**

TYPE	A	B	C
L-07	1.20	0.45	0.65
L-14	1.90	0.65	1.00
L-15	2.60	0.75	1.20

**Recommended Pattern**

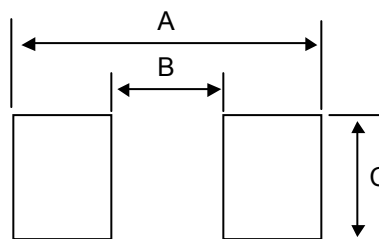

Remark:

- 1) Blank length: 160 mm minimum for loading.
- 2) Blank length: 80 mm minimum for unloading.



**JOHANSON DIELECTRICS, INC.**

SYLMAR, CALIFORNIA

[www.johansondielectrics.com](http://www.johansondielectrics.com)



*Tanceram®  
Ceramic Capacitors*



*High Voltage  
Ceramic Capacitors*

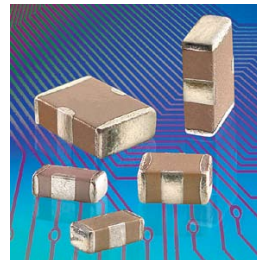

*X2Y®  
EMI Filter Capacitors*

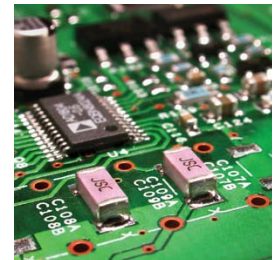

*Y1 & Y2 Safety  
Certified Capacitors*

**ADVANCED MONOLYTHIC CERAMICS**

OLEAN, NEW YORK

[www.amccaps.com](http://www.amccaps.com)

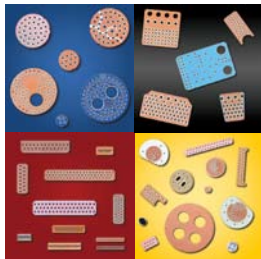

*Ceramic Planar  
Array Filters*

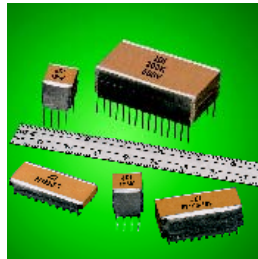

*Switchmode  
Ceramic Capacitors*



*Radial Leaded  
High Voltage MLCCs*

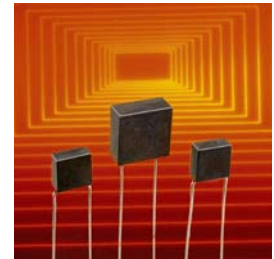

*High Temperature  
Radial Leaded MLCCs*

**FENG HUA ADVANCED TECHNICAL PRODUCTS**

GUANGDONG, CHINA

[www.china-fenghua.com](http://www.china-fenghua.com)

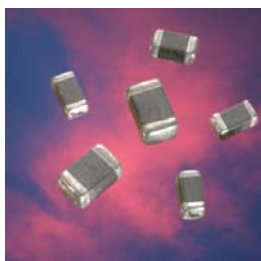

*Surface Mount  
Ferrite Chip Inductors*

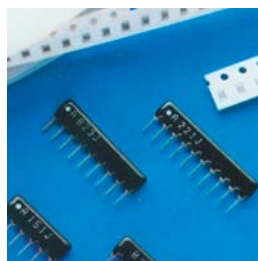

*Resistor Chips  
& Chip Networks*

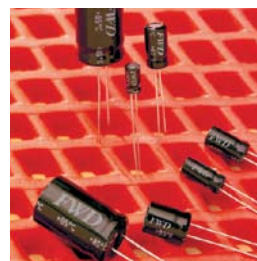

*Aluminum  
Electrolytic Capacitors*



*Varistors  
Leaded & Chip*



[www.johansontechnology.com](http://www.johansontechnology.com)

# Your Technology Partner

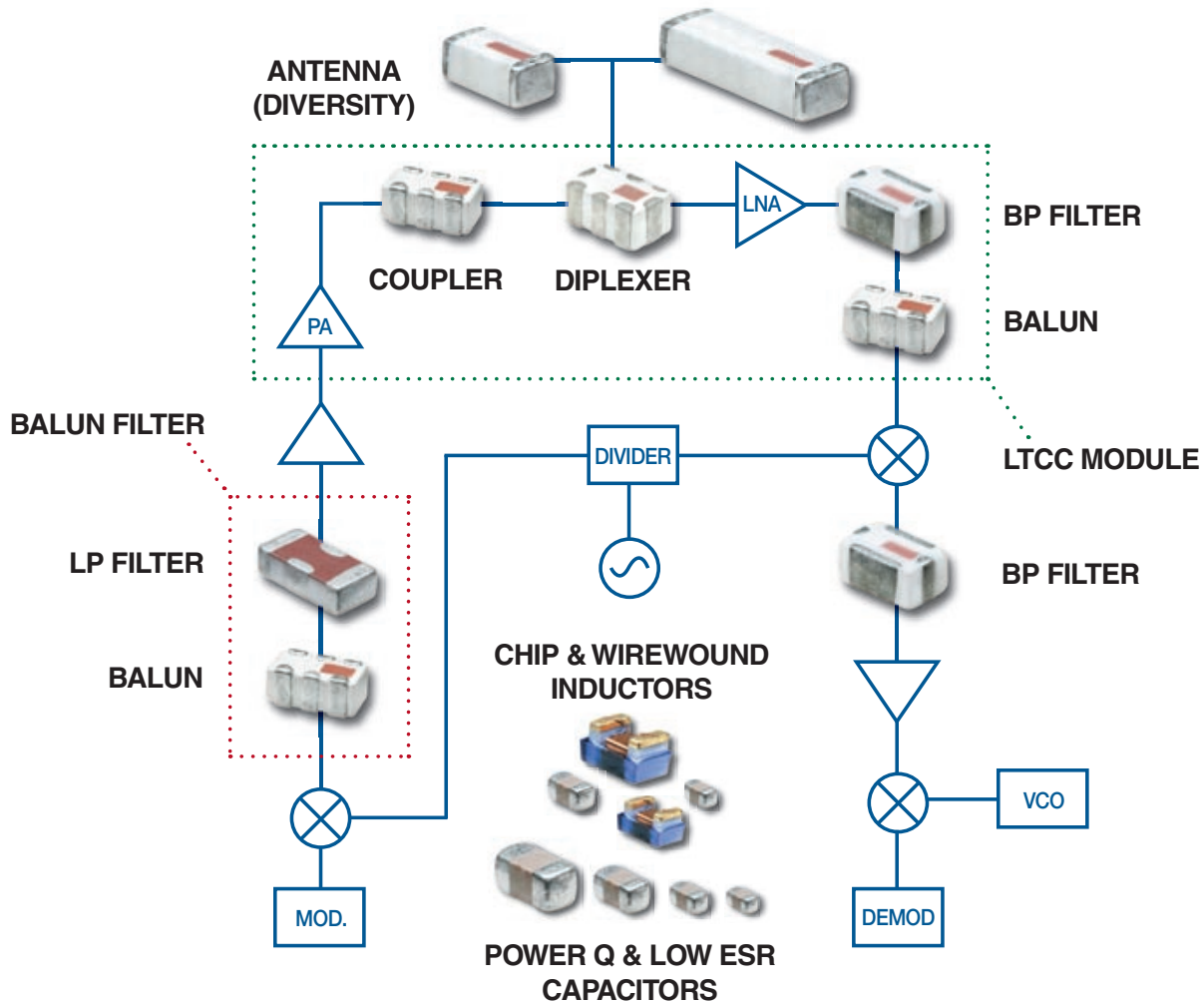

Typical Product Applications:  
WiFi, WiMax, UWB, Bluetooth, Zigbee, GPS, WCDMA/GSM/GPRS & custom



**JOHANSON EUROPE, LTD.**  
Flackwell Heath, Bucks, England  
TEL +44-162-853-1154 • FAX +44-162-853-2703  
eurosales@johansontechnology.com

**HEADQUARTERS**  
4001 Calle Tecate, Camarillo, California 93012  
TEL (805) 389-1166 • FAX (805) 389-1821  
<http://www.johansontechnology.com>

**JOHANSON HONG KONG, LTD.**  
Kowloon, Hong Kong  
TEL +852-2334-6310 • FAX +852-2334-8858  
asiasales@johansontechnology.com

**JOHANSON HONG KONG, LTD. TAIWAN OFFICE**  
10/F., No.380, Sec. 1, Keelung Road,  
Taipei, Taiwan (R.O.C.)  
TEL +886 2 8786 1012 • FAX +886 2 8786 1011  
asiasales@johansontechnology.com

**JOHANSON TRADING (SHENZHEN) CO., LTD.**  
Unit 107, Block 2, 1001 Honghua Road,  
Futian Free Trade Zone, Shenzhen, PRC 518038  
TEL +86 755 8348 4609 • FAX +86 755 8348 4613  
asiasales@johansontechnology.com