

UNCONTROLLED DOCUMENT

SC:0.25

PART NUMBER

SSH-LX3050

REV.

C

UNDER REVISION

REV.	E.C.N. NUMBER AND REVISION COMMENTS	DATE
A	E.C.N. #10BRDR. & REDRAWN.	09.15.99
B	E.C.N. #11476.	02.18.08
C	E.C.N. #11519.	08.07.08

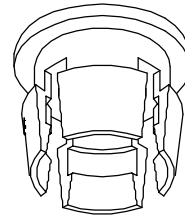
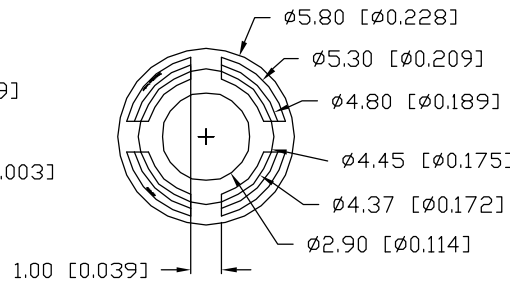
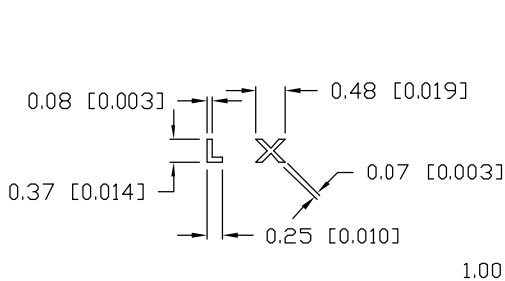
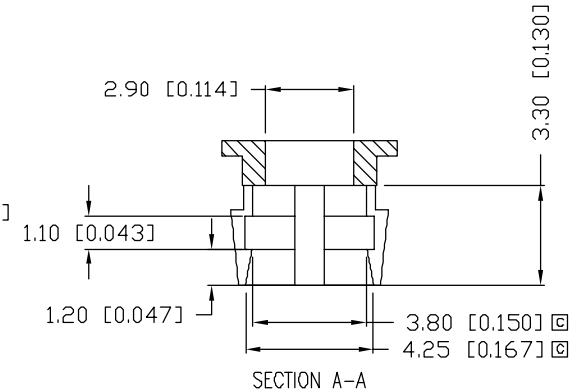
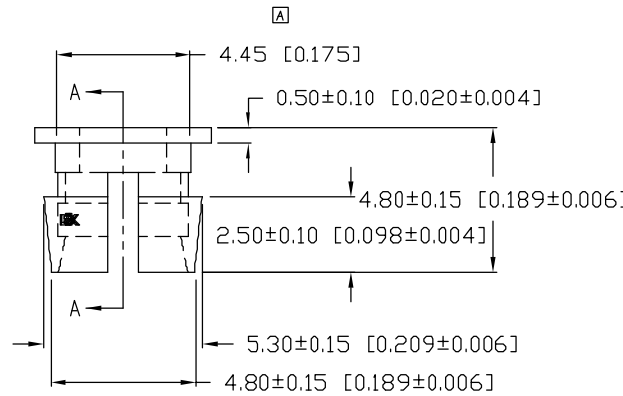
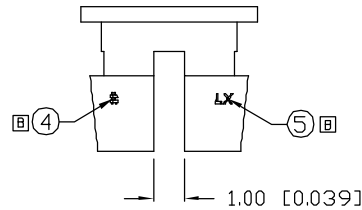
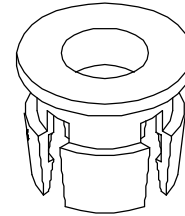
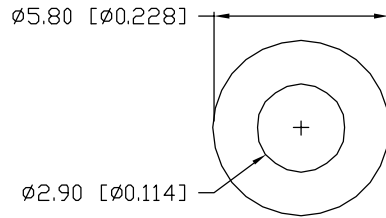

NOTES:

1. MATERIAL: POLYPROPYLENE (PP), BLACK.
2. PANEL HOLE CUT OUT:  $\phi 4.45\text{mm}$  [0.175"].
3. PANEL THICKNESS: 1.65mm [0.065"].
4. CAVITY NUMBER.
5. LX MARKING.



UNCONTROLLED DOCUMENT

\*UNLESS OTHERWISE SPECIFIED TOLERANCES PER DECIMAL PRECISION ARE: X=±1 (±0.039), X.X=±0.5 (±0.020), X.XX=±0.25 (±0.010), X.XXX=±0.127 (±0.005). LEAD SIZE=±0.05 (±0.002), LEAD LENGTH=±0.75 (±0.030). MIN.=+DECIMAL PRECISION -0.00 MAX.=+0.00 -DECIMAL PRECISION

REV.	PART NUMBER
C	SSH-LX3050

**CONFIDENTIAL INFORMATION**  
 THE INFORMATION CONTAINED IN THIS DOCUMENT IS THE PROPERTY OF LUMEX INC. EXCEPT AS SPECIFICALLY AUTHORIZED IN WRITING BY LUMEX INC., THE HOLDER OF THIS DOCUMENT SHALL KEEP ALL INFORMATION CONTAINED HEREIN CONFIDENTIAL AND SHALL PROTECT SAME IN WHOLE OR IN PART FROM DISCLOSURE AND DISSEMINATION TO ALL THIRD PARTIES.



290 E. HELEN ROAD  
 PALATINE, IL 60067-6976  
 PHONE: +1.847.359.2790  
 US WEB: www.lumex.com  
 TW WEB: www.lumex.com.tw

3mm LED PANEL CLIP FOR LX3050 TYPES.

**RELIABILITY NOTE**  
 OUR MANY YEARS OF EXPERIENCE DATA ACCUMULATION INDICATE THAT SOLDER HEAT IS A MAJOR CAUSE OF EARLY AND FUTURE FAILURE. PLEASE PAY ATTENTION TO YOUR SOLDERING PROCESS.

DRAWN BY:	CHECKED BY:	APPROVED BY:	DATE:
DU			03.01.99
			PAGE: 1 OF 1
			SCALE: N/A