

**Input**

Rated input voltage	100 V ~ 240 V ac
Input voltage range	90 V ~ 264 V ac
Rated frequency	50~60 Hz
Frequency range	47~63 Hz
Rated input current	200 mA RMS max.
Inrush current	15 A max. at 115 / 30 A max. at 230 V ac cool start
No load power consumption	0.3 W max. (CEC Compliant)

**Output**

Output voltage	5 V dc at 1.0 A
Output min. current	0 A
Line regulation	± 1%
Load regulation	± 5%
Over voltage protection	9 V dc max. (output shut down)
Short circuit protection	output shut down and auto restart
Ripple voltage	150 mV (p-p) (100~240 V ac at full load)
Efficiency	Energy Star Compliant - Efficiency Level IV
Output connection	USB type A receptacle

**Safety and EMI**

HI-POT	input to output	3000 V ac or 4242 V dc at 10 mA for 1 min.
Insulation resistance	input to output	> 100 M Ohm at 500 V dc
Safety approvals	UL/cUL	
EMI standard	FCC class B, EN55022	
RoHS compliant	yes	
Leakage current	0.25 mA	

**Environmental**

Storage temperature	-10°C ~ +70° C
Operating temperature	0°C ~ +40° C
Storage humidity	10~90%
Operating humidity	20~80%

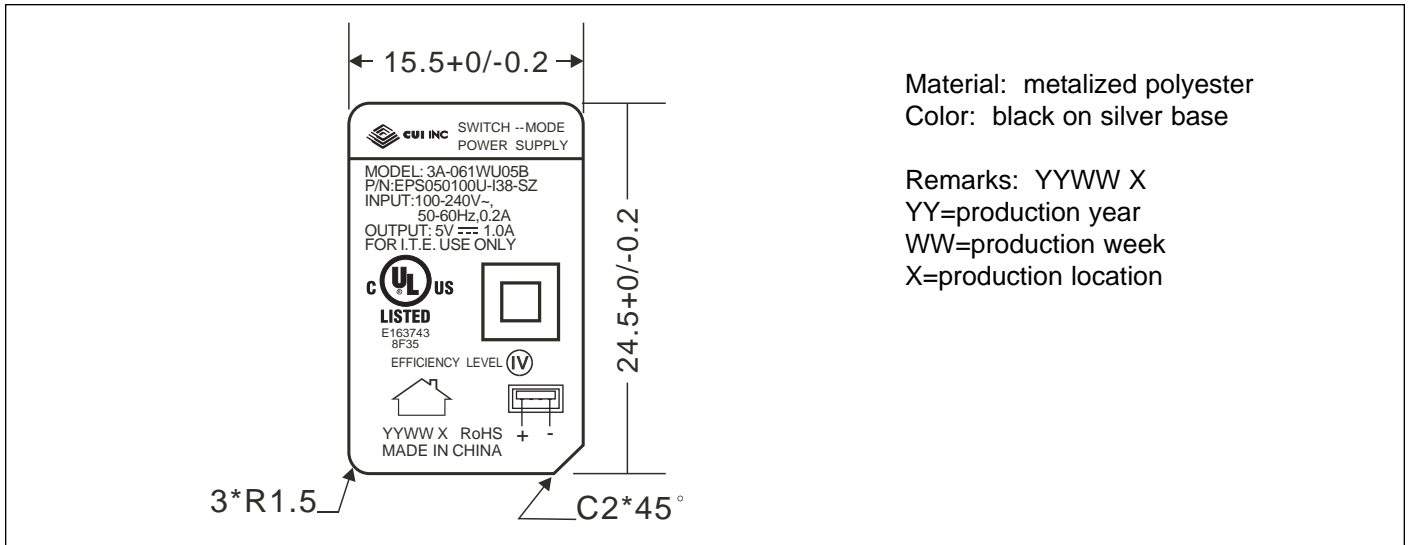
**Label**

**Mechanical Drawing**

 Tolerance:  $\pm 1$ 

Input plug	Direct plug-in UL type
Weight	63 g
Case size	73 L x 29 W x 44.5 H mm
Output connection	USB type A receptacle

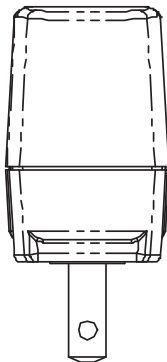
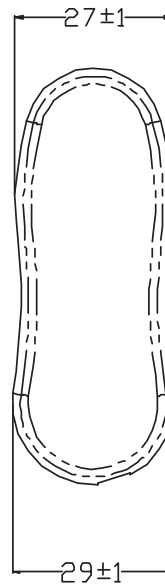
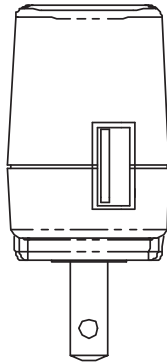
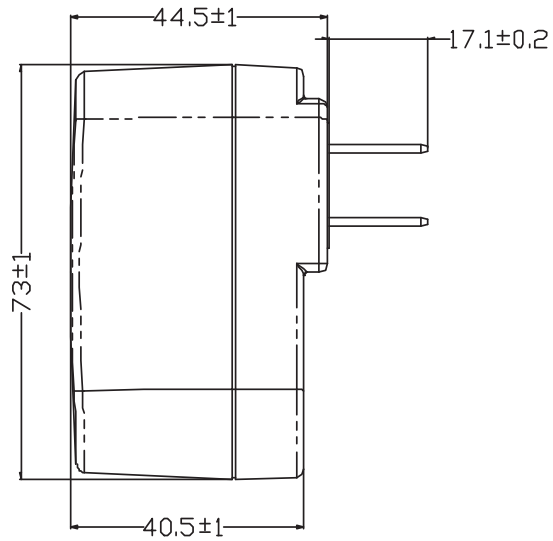
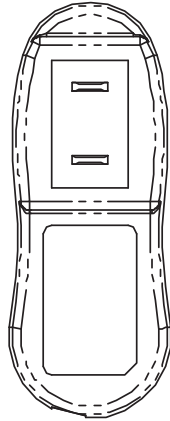

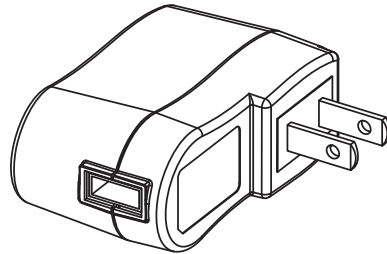
**Individual Packaging**Tolerance:  $\pm 1$ 

← PRODUCT

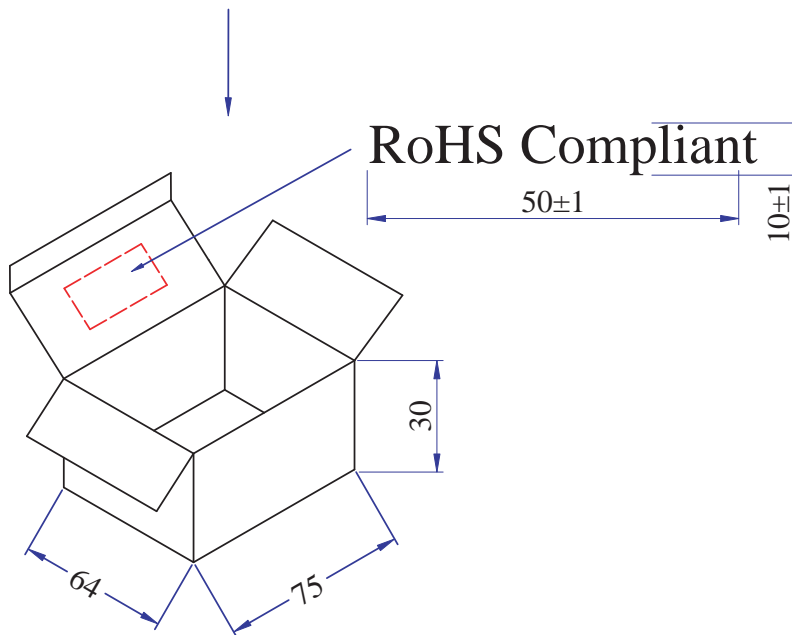

## Packaging

Tolerance: +7/-0

CORTON SIZE: 352\*327\*188mm

Q' TY: 100PCS(20\*5)

N. W: 6.3KGS

G. W: 6.8KGS

G. W: 7.6KGS

"RoHS Compliant"

