

**Accessories Industrial Power Relay RT**

- For Industrial Power Relay RT  
pinnings 3.5mm / 5mm; relay height 15.7 mm
- New retainer clip with ejection function
- Easy replacement of relays on a densely packed DIN rail
- No reduction of protection class or creepage/clearance with plastic retainer
- Simple plug-in indicator- and protection modules
- White snap-on marking tags
- RoHS compliant (Directive 2002/95/EC)



F0228-F

**Premium socket with screwless terminals for DIN rail mounting**

RT 78 72P Premium socket, logical terminal arrangement

- Screwless Clamps
- Mounting of solid wires without tool
- Double Clamps per terminal
- Jumper links for interconnection
- Open coil circuit for active modules
- Logical terminal arrangement



**Approvals**

VDE REG.-Nr. 6106, cULus E135149

**Technical data**

Rated current	2 x 8 A, 16 A*)
Rated voltage / max. switching voltage AC	240/400 VAC
Dielectric strength coil-contact circuit	5000 Vrms
open contact circuit	1000 Vrms
adjacent contact circuits	2500 Vrms
Clearance / creepage coil-contact circuit	≥ 10 / 10 mm
Material group of insulation parts	≥ IIIa
Insulation to IEC 60664-1	
Type of insulation coil-contact circuit	reinforced
open contact circuit	functional
adjacent contact circuits	functional
Rated insulation voltage	250 V
Pollution degree	2
Rated voltage system	230/400 V
Overvoltage category	III
RoHS - Directive 2002/95/EC	compliant
Degree of protection DIN 40050	IP20

\*) For 1 pole relays (16 A) the relay terminals 11-21, 12-22 and 14-24 have to be bridged.

- Not suitable for bistable relays with 2 coils!



**Accessories Industrial Power Relay RT (Continued)**

**Technical data (Continued)**

Ambient temperature range	
for mounting/handling	-20...+70°C
in operation	-40...+70°C
Terminals	screwless
Wire strip length	12 mm
Wire cross section	
solid wire	1 x 0.75/1.5 mm <sup>2</sup> 2 x 0.75/1 mm <sup>2</sup>
with standard isolation (no oversize isolation)	2 x 1.5 mm <sup>2</sup>
stranded wire	
without bootlace crimp	1 x 0.75/1.5 mm <sup>2</sup> 2 x 0.75/1 mm <sup>2</sup>
without bootlace crimp with standard isolation	2 x 1.5 mm <sup>2</sup>
with bootlace crimp	1 x 0.75/1 mm <sup>2</sup> 2 x 0.75 mm <sup>2</sup>
with bootlace crimp without isolation	1 x 1.5 mm <sup>2</sup>
or isolation min 18 mm long	
For stranded wires with braids 0.05 mm or smaller the use of bootlace crimps is recommended. When using stranded wires without bootlace crimp the clamp must be opened during insertion.	
Insertion cycles	A (10)
Max. Insertion Force total	100 N
Mounting distance	0, dense packing
Weight	36 g
Packaging unit	10 pcs

**Socket with screwless terminals for DIN rail mounting**

Type	Part Number
<b>RT 78 72P</b> Premium socket, logical terminal arrangement Socket with screwless terminals, pinning 5 mm for DIN rail mounting	1860200-1

**Accessories for RT 78 72P**

Type	Part Number
<b>RT 17 017</b> Plastic retaining clip, relay height 15.7	2022103-1
<b>RT 17 040</b> Marking tag	2-1415038-1
<b>RT 17 0P1</b> Jumper link, max load 12 A	1860211-1

**How to use, Precautions**



Jumper link



**Accessories Industrial Power Relay RT (Continued)**

**Socket with screw-type terminals for DIN rail mounting**

**RT 78 724** Socket with screw-type terminals, pinning 3.5 mm for DIN rail mounting

**RT 78 726** Socket with screw-type terminals, pinning 5 mm for DIN rail mounting, logical terminal arrangement

- Din-rail socket with logical setup of connections (input/output)
- High quality rising clamp terminals
- Captive combination terminal screws
- Jumper bars for interconnection



**RT 78 725** Socket with screw-type terminals, pinning 5 mm for DIN rail mounting, conventional terminal arrangement

- Conventional terminal arrangement

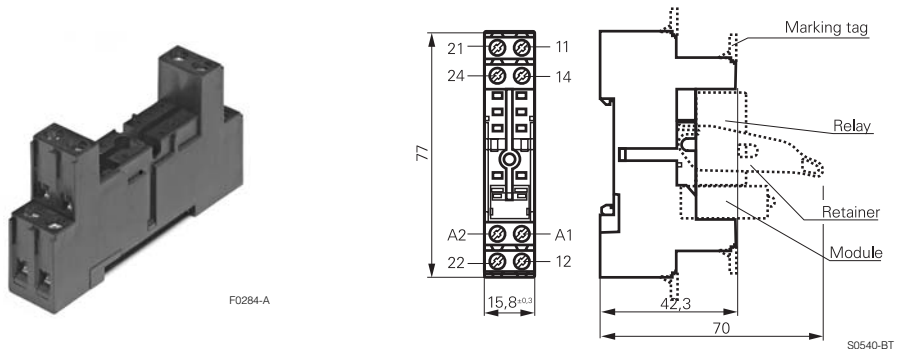

**Approvals**

VDE REG.-Nr. 6106 in preparation, **UL** US E135149

\*) For 1 pole relays (16 A) the relay terminals 11-21, 12-22 and 14-24 have to be bridged.  
For 1 pole relays (12 A) the relay terminals 11-12-14 have to be connected to the socket terminals 21-12-24

Technical data	RT 78 724 / RT 78 726	RT 78 725
Rated current	12 A, 2 x 8 A, 16 A*)	
Rated voltage / max.switching voltage AC	240/400 VAC	
Dielectric strength coil-contact circuit	5000 Vrms	4000 Vrms
open contact circuit	1000 Vrms	1000 Vrms
adjacent contact circuits	2500 Vrms	2500 Vrms
Clearance / creepage coil-contact circuit	≥ 10 / 10 mm	≥ 4.7 / 4.7 mm
Material group of insulation parts	≥ IIIa	
Insulation to IEC 60664-1		
Type of insulation coil-contact circuit	reinforced	basic
open contact circuit	functional	functional
adjacent contact circuits	functional	functional
Rated insulation voltage	250 V	
Pollution degree	2	
Rated voltage system	230/400 V	
Overvoltage category	III	
RoHS - Directive 2002/95/EC	compliant	
Degree of protection DIN 40050	IP20	
Ambient temperature range		
for mounting/handling	-20...+70°C	
in operation	-40...+70°C	

- Not suitable for bistable relays with 2 coils!

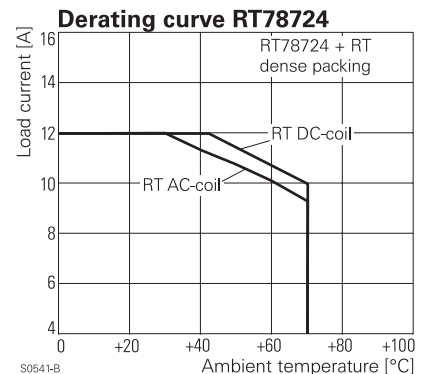

**Accessories Industrial Power Relay RT (Continued)**

Technical data (Continued)	RT 78 724 / RT 78 726	RT 78 725
Terminals		screw
Terminal screw torque acc. IEC 61984 max.		0.5 Nm 0.7 Nm
Wire cross section		
single wire		2 x 2.5 mm <sup>2</sup>
fine wire		2 x 2.5 mm <sup>2</sup>
with bootlace crimp (DIN 46228/1)		2 x 1.5 mm <sup>2</sup>
Insertion cycles		A (10)
Max. Insertion Force total		100 N
Mounting distance		0, dense packing
Weight		36 g
Packaging unit		10 pcs



Socket with screw-type terminals for DIN rail mounting		
Type		Part Number
<b>RT 78 724</b>	Socket with screw-type terminals, pinning 3.5 mm for DIN rail mounting, logical terminal arrangement	8-1415035-1
<b>RT 78 726</b>	Socket with screw-type terminals, pinning 5 mm for DIN rail mounting, logical terminal arrangement	6-1415035-1
<b>RT 78 725</b>	Socket with screw-type terminals, pinning 5 mm for DIN rail mounting, conventional terminal arrangement	1860306-1



Accessories for RT 78 724, RT 78 725, RT 78 726		
Type		Part Number
<b>RT 17 017</b>	Plastic retaining clip, relay height 15.7	2022103-1
<b>RT 17 040</b>	Marking tag	2-1415038-1
<b>RT 17 0R8</b>	Jumper bar, max load 12 A for connection of up to 8 RT sockets	1860517-8

Jumper bar



Marking tags

- White marking area 15.5 x 6 mm
- Snaps on socket in up to 4 positions

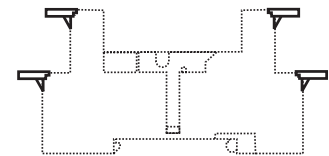
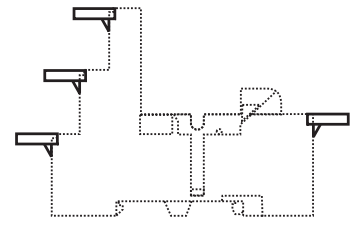

**Accessories Industrial Power Relay RT (Continued)**

**LED- and Protection Modules for RT 78 72P, RT 78 724, RT 78 725, RT 78 726**

Easy insertion of module into the socket  
Wiring in parallel to the coil

Type	Part Number
<b>PTM TO 0A0</b> EM09 Protection diode (standard, A1+, A2-)	9-1415036-1
<b>PTM TO 0L0</b> EM01 Protection diode (A1-, A2+)	1415037-1
<b>PTM U0 524</b> EM02 RC-network 6...60 VAC	1-1415037-1
<b>PTM U0 730</b> EM03 RC-network 110...230 VAC	2-1415037-1
<b>PTM V0 524</b> EM04 Varistor 24 VAC	3-1415037-1
<b>PTM V0 615</b> EM13 Varistor 115 VAC	6-1415365-1
<b>PTM V0 730</b> EM05 Varistor 230 VAC	4-1415037-1
<b>PTM R0 730</b> EM29 Bleeder Resistor 110...230 VAC	1-1415539-2



F0231-A

F0232-A

**LED**

<b>PTM LO 024</b> EM18 red LED 6...24 VDC w. prot.diode (std, A1+, A2-)	5-1415036-1
<b>PTM GO 024</b> EM12 green LED 6...24 VDC w. prot.diode (std, A1+, A2-)	2-1415036-1
<b>PTM L1 024</b> EM08 red LED 6...24 VDC w. prot. diode (A1-, A2+)	8-1415036-1
<b>PTM LO 060</b> EM16 red LED 24...60 VDC w. prot.diode (std, A1+, A2-)	5-1415539-3
<b>PTM GO 060</b> EM25 green LED 24...60 VDC w. prot.diode (std, A1+, A2-)	7-1415539-7
<b>PTM LO 110</b> EM19 red LED 60...110 VDC w. prot. diode (A1+, A2-)	2-1415392-1
<b>PTM GO 110</b> EM26 green LED 60...110 VDC w. prot diode (A1+, A2-)	1-1415539-7
<b>PTM LO 220</b> EM27 red LED 110...220 VDC w. prot. diode (A1+, A2-)	1-1415539-4
<b>PTM GO 220</b> EM28 green LED 110...220 VDC w. prot diode (A1+, A2-)	1-1415539-6
<b>PTM LO 524</b> EM07 red LED 6...24 VDC/VAC	6-1415036-1
<b>PTM GO 524</b> EM11 green LED 6...24 VDC/VAC	3-1415036-1
<b>PTM LO 560</b> EM14 red LED 24...60 VDC/VAC	1-1415539-3
<b>PTM GO 560</b> EM30 green LED 24...60 VDC/VAC	1-1415539-5
<b>PTM LO 730</b> EM06 red LED 110...230 VAC	7-1415036-1
<b>PTM GO 730</b> EM10 green LED 110...230 VAC	4-1415036-1

**Relay Packages**

Complete packages consisting of a relay mounted on a socket: see Relay Package RT

**Accessories Industrial Power Relay RT (Continued)**

**Sockets for PCB mount**

**RP 78 601** Socket with PCB terminals, pinning 3.5 mm



F0116-A

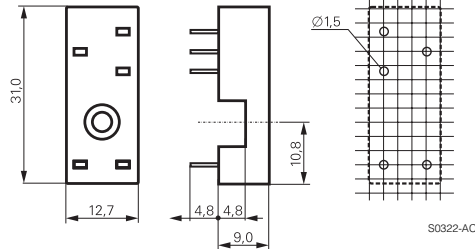

S0322-AC

**RP 78 602** Socket with PCB terminals, pinning 5 mm



F0117-A

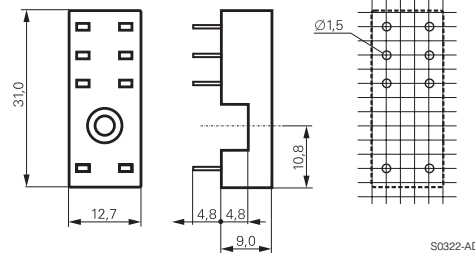

S0322-AD

**Approvals**



**Technical data**

**RP 78 601 / RP 78 602**

Rated current	12 A *)
Limiting continuous current	see derating curve
Rated voltage / max. switching voltage AC	240/400
Dielectric strength coil-contact circuit	4000 V <sub>rms</sub>
open contact circuit	1000 V <sub>rms</sub>
adjacent contact circuits	2500 V <sub>rms</sub>
Clearance / creepage coil-contact circuit	≥ 10 / 10 mm
Material group of insulation parts	≥ IIIa
Insulation to IEC 60664-1	
Type of insulation coil-contact circuit	reinforced
open contact circuit	functional
adjacent contact circuits	functional
Rated insulation voltage	250 V
Pollution degree	2
Rated voltage system	230/400 V
Overvoltage category	III
RoHS - Directive 2002/95/EC	compliant
Degree of protection DIN 40050	IP20
Ambient temperature range	-40...+80°C
Terminals	pcb
Insertion cycles	A (10)
Max. Insertion Force total	100 N
Mounting distance	0, dense packing
Resistance to soldering heat	270°C / 10 s
Weight	3 g
Packaging unit	100 pcs

**Derating curve RP78601**

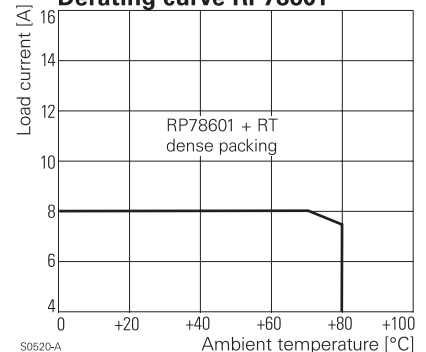

S0520-A

**Derating curve RP78602**

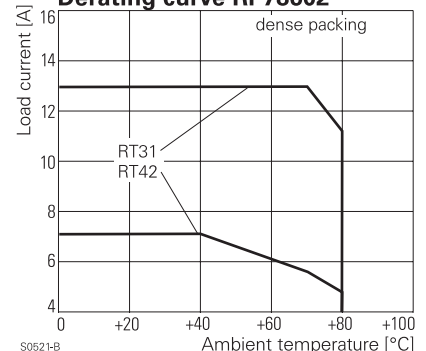

S0521-B

**Socket with PCB terminals**

Type	Part Number
<b>RP 78 601</b> Socket with PCB terminals, pinning 3.5 mm	8-1393234-4
<b>RP 78 602</b> Socket with PCB terminals, pinning 5 mm	8-1393234-5

**Accessories for RP 78 601, RP 78 602**

Type	Part Number
<b>RT 16 041</b> Plastic retaining clip RT, relay height 15.7 mm	3-1393161-4
<b>RT 28 516</b> Metal retaining clip RT, relay height 15.7 mm	1419108-7

\*) For 1 pole relays (16 A) the relay terminals 11-21, 12-22 and 14-24 have to be bridged on the PCB.