

KT Series Right Angle Sealed Tact Switch for SMT



Features/Benefits

- High shear force with extended bracket
- Easy to pick & place with top plate tab
- Rubber or hard plastic actuator
- Press fit or snap fit caps
- IP 57
- RoHS compliant and compatible

Typical Applications

- Telecommunications
- Computer products
- Instrumentation
- Power supply

Specification

CONTACT ARRANGEMENT: SPST, N.O.
TERMINALS: Gullwing type for SMT

Electrical

CONTACT RATING: 1.0 VA max. @ 32 V AC or DC max.
ELECTRICAL & MECHANICAL LIFE: 100,000 make-and-break cycles at full load.
DIELECTRIC STRENGTH: 250 Vrms min. @ sea level.
CONTACT RESISTANCE: Below 50 mΩ typ. initial @ 2-4 V DC, 100 mA.
INSULATION RESISTANCE: 10⁹ Ω min.

Environmental

OPERATING TEMPERATURE: -40°C to 90°C

Process

SOLDERABILITY: Per MIL-STD-202F method 208D, or EIA RS-186E method 9 (1 hour steam aging).
DEGREE OF PROTECTION: IP57; protection against harmful dust deposits, full-scale voltage protection.

Packaging

Switches supplied in rigid dispensing tubes or anti-static tape and reels per EIA 481-2 (800 pieces per reel.). Tape and cover strip are conductive for use near statically sensitive components.

NOTE: Specifications listed above are for switches with standard options.
For information on specific and custom switches, consult Customer Service Center.

How To Order

Our easy build-a-switch concept allows you to mix and match options to create the switch you need. To order, select desired option from each category and place it in the appropriate box.

However, please note that all the combinations of these options are not feasible.

For any part number different from those listed above, please consult your local representative.

SWITCH

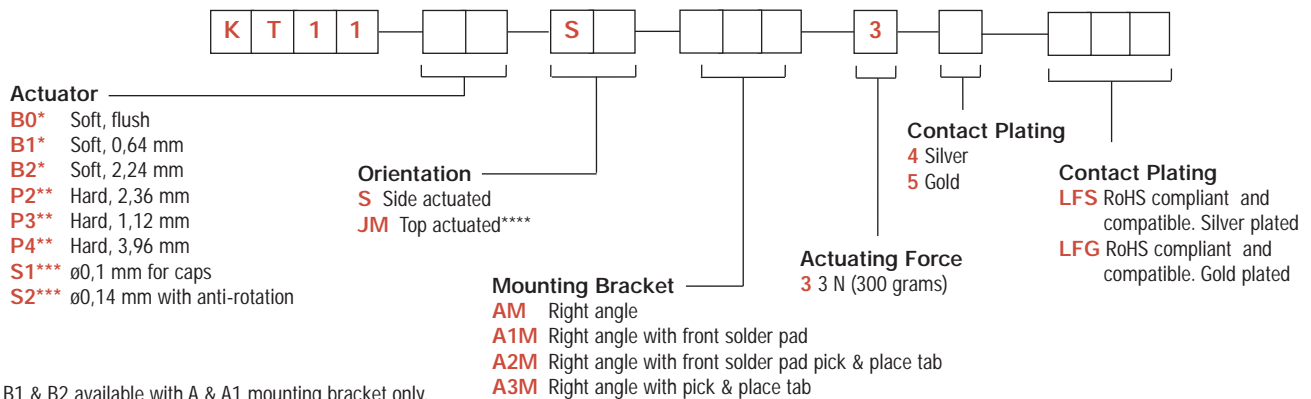

* B0, B1 & B2 available with A & A1 mounting bracket only.

** P4 available with A1 & A2 mounting bracket only.

*** S1 & S2 available with A1 & A2 mounting bracket only.

**** JM available with B0, B1, B2, P2, P3, P4 without mounting bracket.

BUTTON

To order buttons in bulk

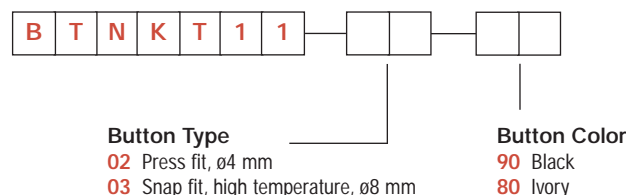

Dimensions shown in: mm (inch)
Specifications and dimensions subject to change

www.ck-components.com

KT Series Right Angle Sealed Tact Switch for SMT

SERIES

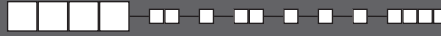

KT11

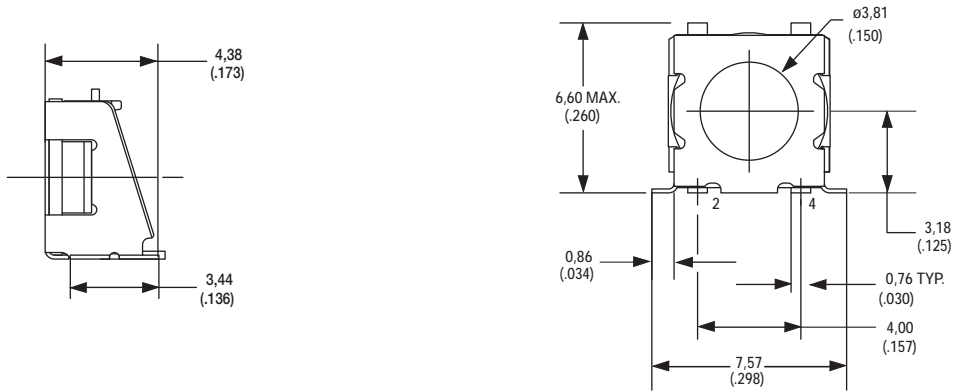

ACTUATOR



B0 SOFT, FLUSH*

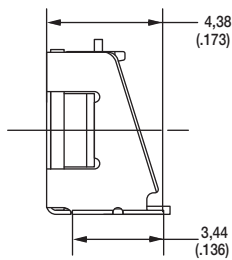

B1 SOFT, 0,64 mm*

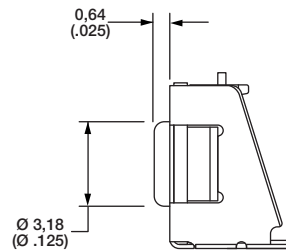

B2 SOFT, 2,24 mm*

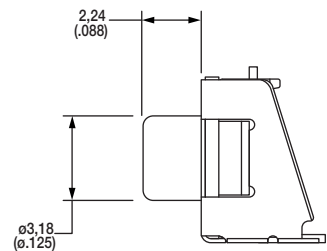

P2 HARD, 2,36 mm

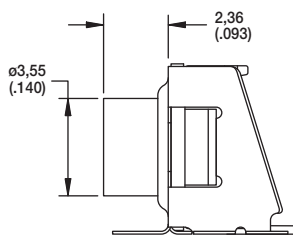

P3 HARD, 1,12 mm

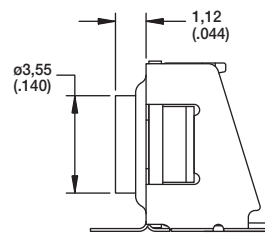

P4 HARD, 3,96 mm**

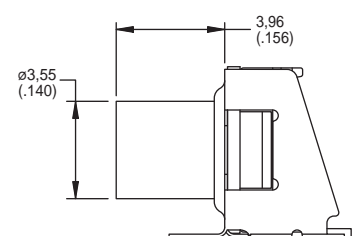

S1 $\phi 0,1$ mm FOR PRESS FIT CAPS***

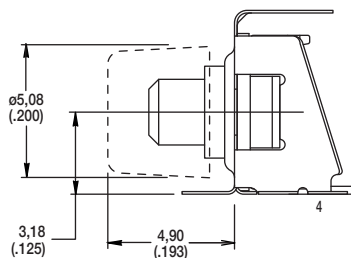

S2 $\phi 0,14$ mm FOR SNAP FIT CAPS***

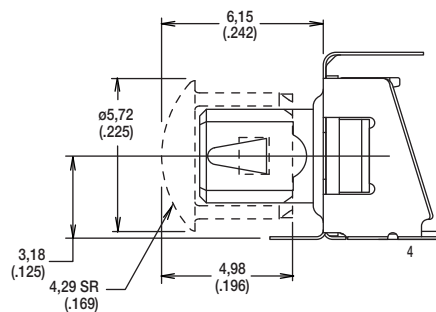

First Angle
Projection

Dimensions shown in: mm (inch)
Specifications and dimensions subject to change



KT Series Right Angle Sealed Tact Switch

MOUNTING BRACKET

PAD LAYOUT
AM & A3M MOUNTING BRACKET

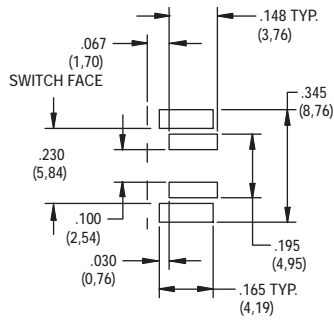

PAD LAYOUT
A1M & A2M MOUNTING BRACKET

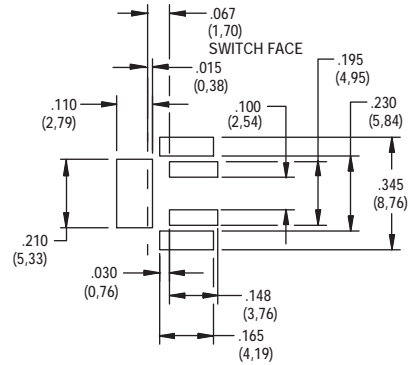

ACTUATING FORCE

OPTION CODE	FORCE
3	3 N (300 grams)

CONTACT PLATING

OPTION CODE	MATERIAL
4	SILVER
5	GOLD

BUTTON

BUTTON

To order buttons in bulk

B T N K T 1 1

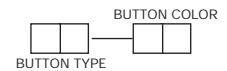

Button Type

02 PRESS FIT, Ø4 mm

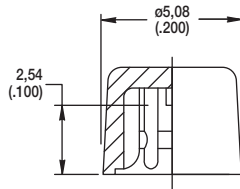

03 SNAP FIT, HIGH TEMPERATURE, Ø8 mm

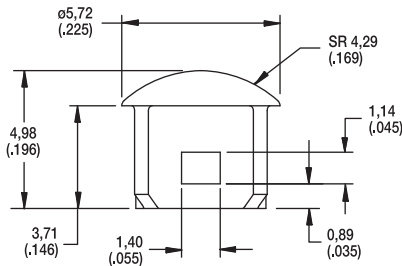

Button Color

OPTION CODE	BUTTON COLOR
90	BLACK
80	IVORY



First Angle
Projection



Dimensions shown in: mm (inch)
Specifications and dimensions subject to change