

Lighted Pushbutton Switch

A3A

Compact Switch Allows Signal and Power Switching with the Same Model

- Compact, high-capacity push-button switch that has contacts with a 3-mm gap and is ideal as a power switch.
- Capable of switching within the range of 1 mA, 5 VDC to 6 A, 125 VAC.
- Requires only 14.5 mm behind the panel.
- Options include the following:
 - Round or square
 - Momentary or alternate
 - Surface illumination or non-lighted
- UL and CSA approved.



Ordering Information

Model Number Legend

A 3 A A - 9 0 K 1 - 00E R

(1) Shape

Symbol	Protection
A	Square
T	Round

(2) Terminal

Symbol	Type
0	Solder
1	PCB

(3) Switch

Symbol	Operation	Contact type	
A (See note)	Momentary	SPDT	3 A at 125 VAC, 2 A at 30 VDC
B (See note)	Alternate		
K	Momentary	SPST-NO	6 A at 125 VAC, 2 A at 250 VAC, 4 A at 30 VDC
L	Alternate		

(4) Illumination

Symbol	Operation
00	Non-lighted
00E	Surface illumination

(5) Color

Pushbutton (Non-lighted Models)

Symbol	Color
L	Light gray
R	Red (See note)
Y	Yellow (See note)
G	Green (See note)
A	Blue
B	Black
D	Dark gray
H	Gray



LED (Surface Illumination Models)

Symbol	Color
R	Red
Y	Yellow
G	Green

Note: Common to both lighted and non-lighted models.

■ List of Models

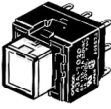
SPST-NO

Appearance	Terminal	Action	Illumination	Model	Color
Square A3AA-9□□1-00□ A3AA-9□□1-00E□ 	Solder	Momentary	Non-lighted	A3AA-90K1-00□	(Non-lighted)
			Surface illumination	A3AA-90K1-00E□	R: red
		Alternate	Non-lighted	A3AA-90L1-00□	Y: yellow
			Surface illumination	A3AA-90L1-00E□	G: green
	PCB	Momentary	Non-lighted	A3AA-91K1-00□	L: light gray (see note)
			Surface illumination	A3AA-91K1-00E□	A: blue (see note)
		Alternate	Non-lighted	A3AA-91L1-00□	B: black (see note)
			Surface illumination	A3AA-91L1-00E□	D: dark gray (see note)
Round A3AT-9□□1-00□ A3AT-9□□1-00E□ 	Solder	Momentary	Non-lighted	A3AT-90K1-00□	H: gray (see note)
			Surface illumination	A3AT-90K1-00E□	(Lighted)
		Alternate	Non-lighted	A3AT-90L1-00□	R: red
			Surface illumination	A3AT-90L1-00E□	Y: yellow
	PCB	Momentary	Non-lighted	A3AT-91K1-00□	G: green
			Surface illumination	A3AT-91K1-00E□	
		Alternate	Non-lighted	A3AT-91L1-00□	
			Surface illumination	A3AT-91L1-00E□	

Note: The above models each have a SPST-NO contact that can switch 6 A at 125 VAC, 2 A at 250 VAC, and 4 A at 30 VDC. When ordering any of the above models, replace □ of the model number with a code to indicate the pushbutton color of the model (i.e., replace □ with R, Y, G, L, A, B, D, H, and L). The pushbutton of an A3A does not illuminate if the color of the pushbutton is dark gray, gray, light gray, blue, or black.

SPDT

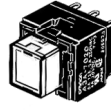
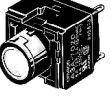



Appearance	Terminal	Action	Illumination	Model	Color
Square A3AA-9□□1-00□ A3AA-9□□1-00E□ 	Solder	Momentary	Non-lighted	A3AA-90A1-00□	R: red
			Surface illumination	A3AA-90A1-00E□	Y: yellow
		Alternate	Non-lighted	A3AA-90B1-00□	G: green
			Surface illumination	A3AA-90B1-00E□	L: light gray (see note)
	PCB	Momentary	Non-lighted	A3AA-91A1-00□	A: blue (see note)
			Surface illumination	A3AA-91A1-00E□	B: black (see note)
		Alternate	Non-lighted	A3AA-91B1-00□	D: dark gray (see note)
			Surface illumination	A3AA-91B1-00E□	H: gray (see note)
Round A3AT-9□□1-00□ A3AT-9□□1-00E□ 	Solder	Momentary	Non-lighted	A3AT-90A1-00□	(Lighted)
			Surface illumination	A3AT-90A1-00E□	R: red
		Alternate	Non-lighted	A3AT-90B1-00□	Y: yellow
			Surface illumination	A3AT-90B1-00E□	G: green
	PCB	Momentary	Non-lighted	A3AT-91A1-00□	
			Surface illumination	A3AT-91A1-00E□	
		Alternate	Non-lighted	A3AT-91B1-00□	
			Surface illumination	A3AT-91B1-00E□	

Note: The above models each have a SPDT contact that can switch 3 A at 125 VAC and 2 A at 30 VDC. When ordering any of the above models, replace □ of the model number with a code to indicate the pushbutton color of the model (i.e., replace □ with R, Y, G, L, A, B, D, H, and L). The pushbutton of an A3A does not illuminate if the color of the pushbutton is dark gray, gray, light gray, blue, or black.

■ Accessories (Order Separately)

Flange

Select according to panel color.

Name	Shape	Classification		Model
Flange	Square, 12.7 x 12.7 	Flange alone	Black	A3A-241
			Light gray	A3A-242
	Round, 12.7 dia. 		Black	A3A-251
			Light gray	A3A-252
		Leaf spring		A3A-200
	Square, 12.7 x 12.7 	Flange and leaf spring (one each)	Black	A3A-211
			Light gray	A3A-212
	Round, 12.7 dia. 		Black	A3A-221
Light gray			A3A-222	

Note: An A3A with solder terminals is provided with a round or square black flange and leaf spring for the switching mechanism of the A3A. A round black flange is provided with each A3A having solder terminals and a round pushbutton. A square black flange is provided with each A3A having solder terminals and a square pushbutton.

Specifications

■ Contact Ratings

Type	Contact form	Resistive load	
High capacity	SPST-NO	6 A at 125 VAC 2 A at 250 VAC	4 A at 30 VDC

- Note:**
1. Minimum allowable load: 5 VDC 1 mA (Resistive)
 2. The ratings given above are for testing under the following conditions:
 1. Ambient temperature: 20 ±2°C
 2. Ambient humidity: 65 ±5%
 3. Operating frequency: 20 times/minute

■ LED Ratings

Item		Surface illumination		
		Red	Yellow	Green
Forward voltage V_F	Standard value	2.0 V	2.1 V	2.1 V
	Maximum value	3 V		
Forward current I_F	Standard value	10 mA		
	Maximum value	20 mA	25 mA	25 mA
Permissible loss PD	Absolute max. value	60 mW	75 mW	75 mW
Reverse voltage V_R	Absolute max. value	3 V		

- Note:**
1. The above built-in LEDs do not have a resistor. Connect to each of the above built-in LEDs a resistor that satisfies the above conditions.
 2. Refer to the $V_F - I_F$ characteristic graphs on page 219.

■ Characteristics

Operating frequency	Mechanical: Momentary action: 120 operations/minute max. Alternate action: 60 operations/minute max. (See note 1.) Electrical: 20 operations/minute max.
Insulation resistance	100 MΩ min. (at 500 VDC)
Contact resistance	100 mΩ max. (initial value)
Dielectric strength	600 VAC, 50/60 Hz for 1 min between terminals of same polarity 2,000 VAC, 50/60 Hz for 1 min between each terminal and ground 600 VAC, 50/60 Hz for 1 min between LED terminals (See note 2.)
Vibration resistance	Malfunction: 10 to 55 Hz, 1.5-mm double amplitude (See note 3.)
Shock resistance	Destruction: 500 m/s ² Malfunction: 150 m/s ² (See note 3.)
Life expectancy	Mechanical: Momentary action: 1,000,000 operations min. Alternate action: 50,000 operations min. (See note 1.) Electrical: 50,000 operations min.
Weight	Approx. 3.2 g
Ambient temperature	Operating: -10°C to 55°C (with no icing) Storage: -25°C to 65°C
Ambient humidity	Operating: 35% to 85%
Degree of protection	IP00
Electric shock protection class	Class II
PTI (proof tracking index)	175
Pollution degree	3 (IEC947-5-1)

- Note:**
1. With alternate-action models, a setting and resetting is regarded as one operation.
 2. The figure for the dielectric strength between LED terminals in the above table is for when the LED is not installed in the Switch.
 3. The figures for malfunctions in the above table are for malfunctions of at least 1 ms.

■ Approved Standards

UL (File No. E41515)/CSA (File No. LR45258)

SPST-NO: 6 A at 125 VAC, 2 A at 250 VAC, 4 A at 30 VDC
SPDT: 3 A at 125 VAC, 2 A at 30 VDC

■ Operating Characteristics

OF max.	2.45 N
RF min.	0.15 N
TT	Approx. 2 mm
PT max.	1.5 mm
LTA min. (See note.)	0.5 mm

Note: The above lock stroke figure applies to A3A alternate operation models only.

Nomenclature

Pushbutton

Square (A3AA)



Round (A3AT)



Diffusion sheet (milky white)

Flange

Leaf spring

Color cap

Color

Non-lighted Model

Red, yellow, light gray, gray, dark gray, green blue, black

Surface Illumination Model

Red, yellow, green

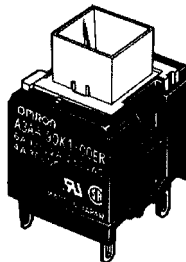

Switch

Ratings (Standard load)

- 6 A at 125 VAC
- 2 A at 250 VAC
- 4 A at 30 VDC
- Minimum applicable load:
- 1 mA at 5 VDC (resistive load)

Terminals

- Solder terminal
- PCB terminal

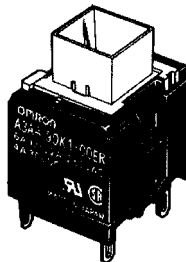

■ Contact Form

Contact Type

Contact form	Contact type
SPST-NO	
SPDT	

- Note:**
1. The above is for the A3AA.
 2. An A3A with solder terminals is provided with a black flange and leaf spring for the switching mechanism, however an A3A with PCB terminals is not provided with them. If a black flange and leaf spring are required for an A3A with PCB terminals, order them from your OMRON representative.

Dimensions

- Note:** 1. All units are in millimeters unless otherwise indicated.
 2. The illustrations below show switches with solder terminals, without a flange or leaf spring.

Non-lighted Model

Square Pushbutton

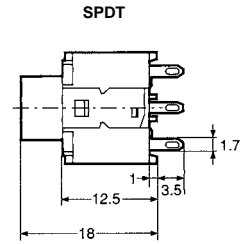
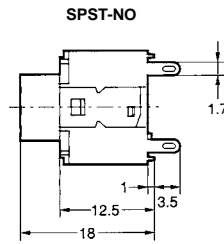
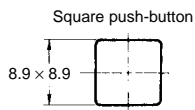
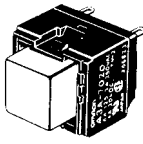

Round Pushbutton

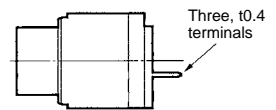
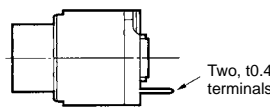
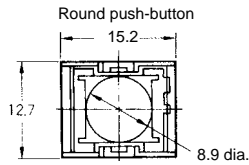
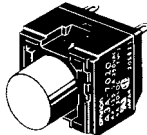

Surface Illumination Model

Square Pushbutton

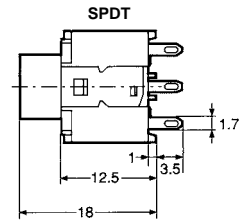
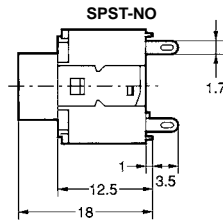
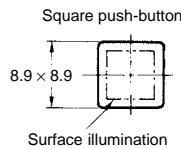
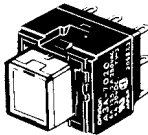

Round Pushbutton

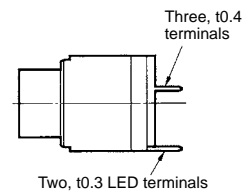
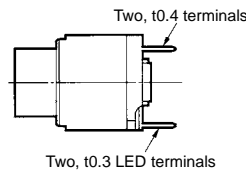
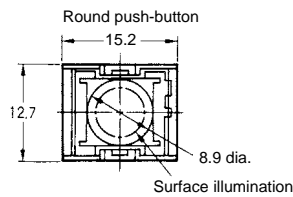
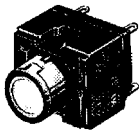

Accessories (Order Separately)

Note: Unless otherwise specified, a tolerance of ± 0.4 mm applies to all dimensions.

Leaf Spring A3A-200

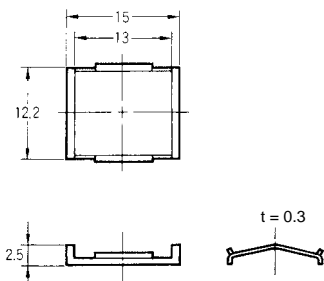

Flange (Square) A3A-24

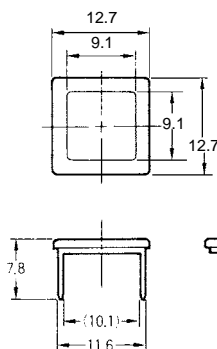

Flange (Round) A3A-25

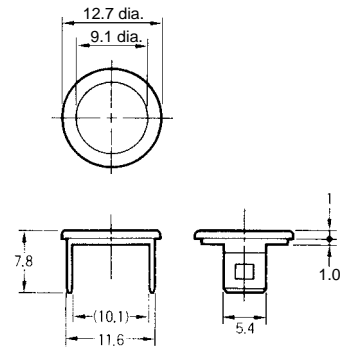

■ Panel Cutouts

Square Pushbutton

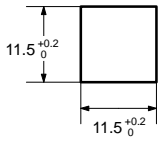

Round Pushbutton

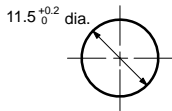

Panel Mounting Dimensions

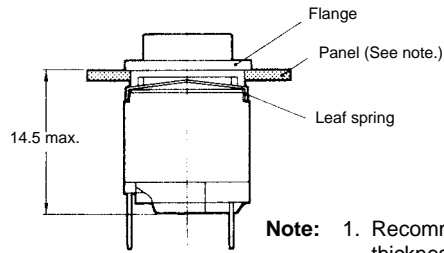

- Note:**
1. Recommended panel thickness: 1 to 1.6 mm
 2. The diagram shows the lighted SPST-NO model.

For Side-by-side Mounting

Mounting	Square pushbutton	Round pushbutton
Horizontal multiple mounting		
Vertical multiple mounting		

■ Terminals

	Solder terminal	PCB terminal	
SPST-NO	<p>Non-lighted Models</p> <p>Switch terminal: t0.4</p> <p>Lighted Models</p> <p>Switch terminal: t0.4 Lamp terminal: t0.3</p> <p>Terminal Arrangement (Bottom View)</p> <p>Terminal for models with an illuminating push-button</p>	<p>Non-lighted Models</p> <p>Switch terminal: t0.4</p> <p>Terminal Arrangement (Bottom View)</p> <p>Terminal for models with an illuminating push-button</p>	<p>Lighted Models</p> <p>Switch terminal: t0.4 Lamp terminal: t0.3</p> <p>PCB Dimensions (Bottom View)</p> <p>Holes for models with illuminating push-button</p>
	SPDT	<p>Non-lighted Models</p> <p>Switch terminal: t0.4</p> <p>Lighted Models</p> <p>Switch terminal: t0.4 Lamp terminal: t0.3</p> <p>Terminal Arrangement (Bottom View)</p> <p>Terminal for models with an illuminating push-button</p>	<p>Non-lighted Models</p> <p>Switch terminal: t0.4</p> <p>Terminal Arrangement (Bottom View)</p>

Installation

Mounting and Replacing the Pushbutton

Mounting Direction for the Pushbutton and Switch

- Insert the catches of the Pushbutton into the grooves of the Switch and push down on the Pushbutton until it is fixed securely to the Switch.
- With lighted models, the LED is built into the Switch and cannot be replaced.

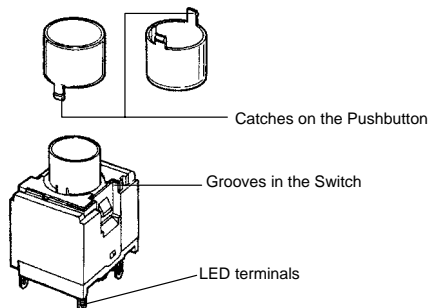

Removing the Pushbutton (Non-lighted Models Only)

- To remove the Pushbutton, hold both the Pushbutton and the Switch on the longer sides and pull the Pushbutton away from the Switch. (If the catches on the Pushbutton are bent outwards, it may result in malfunction.)

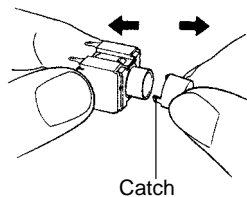

- When replacing the Pushbutton, if the cap is held on the sides with catches, internal components (e.g., plate) may come loose. Be sure to hold the Pushbutton by the sides without catches (i.e., the longer sides of the Switch) when removing.

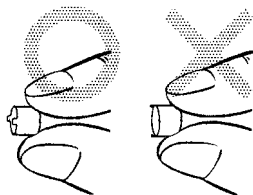

Mounting Switch on a Panel

Mount Leaf Spring

Press the leaf spring into the fitted groove on the upper surface of the Switch. For an easier fitting, first fit one side of the leaf spring, then press the other side into the fitting groove.

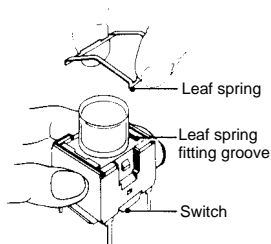

Note: Be sure to fit the leaf spring exactly into the groove, and do not allow it to slip out of the groove.

Mount Flange on Panel

Insert the flange from the front surface of the panel.

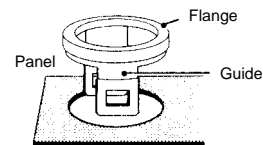

The flange has two opposing guides to facilitate its insertion into the panel cutout hole. Be sure the flange does not remain tilted with respect to the panel surface after being installed.

Cross Section

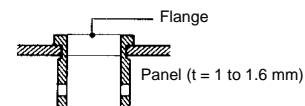

Note: The mounting direction of the flange determines the orientation of the Switch.

Fit Flange with Switch

While holding the flange, insert the opposing supports into the gaps between the leaf spring and Switch on the longer sides of the housing, and fit the rectangular hole of the flange with the projections of the switch housing.

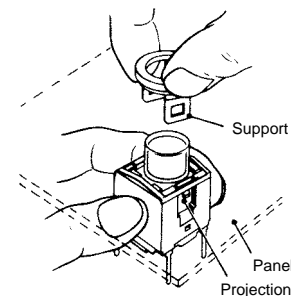

Note: Completely remove any burrs on the panel cutout surface; otherwise, the flange and Switch will not attach solidly.

Removing Switch

Insert a small flat-bladed screwdriver or tweezers into the flange support exposed on the rear of the panel. Pry up on each side to pull out the Switch.

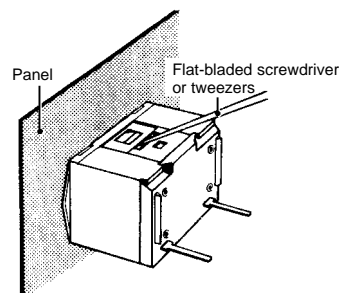

Note: Do not pry up the flange support more than necessary or the switch holding portions may be damaged.

Precautions

Operation

When operating an A3A, make sure that the A3A has a pushbutton. Do not operate the A3A with a screwdriver or tweezers without mounting a pushbutton to the A3A, otherwise the A3A may malfunction.

Mounting

When opening a hole on a panel to mount an A3A to the panel, make sure that the hole has no burr.

When mounting a flange to the switching mechanism of an A3A, make sure that the flange and the casing of the switching mechanism are engaged securely.

Wiring

When soldering the terminals of an A3A, refer to the following.

1. For manual soldering: Use a soldering iron with the terminals at a temperature of 350°C maximum within three seconds.
2. Do not impose any external force on the terminals for one minute after the terminals are soldered.

Do not pull the terminals of any A3A with a force exceeding 5.34 N, otherwise the joint part of the A3A may be damaged.

When soldering the terminals of an A3A, apply non-corrosive rosin flux to the terminals.

After soldering the terminals of an A3A, do not wash the A3A with any solvent.

When mounting an A3A to a PCB and soldering the terminals of the A3A to the PCB, make sure that the flux will not rise above the surface of the PCB.

Operating Environment

When using an A3A, make sure that dust, metal powder, or oil will not penetrate into the interior of the A3A.

LED

The polarity of the LED is indicated on the back of the Switch. Wire the LED correctly according to the polarity.

An A3A with a built-in LED does not have a limiting resistor. Connect a limiting resistor.

The resistance can be calculated by using the following expression.

$$R = (E - V_F) / I_F \ (\Omega)$$

E: Applied voltage (V)

V_F : LED forward voltage (V)

I_F : LED forward current (A)

Note: Make sure that the limiting resistor connected to the built-in LED of an A3A satisfies the characteristics of the built-in LED. The mean forward current of the built-in LED must be 8 mA minimum.

Example

Conditions: Red LED with an I_F of 10 mA at 24 V and a T_a of 25°C. From the red LED characteristic below, V_F will be 2 V when I_F is 10 mA. Therefore, $R = (24 \text{ V} - 2 \text{ V}) / 0.01 \text{ A} = 2,200 \ \Omega$. Thus the recommended resistance is 2.2 k Ω at 0.5 W ($2^* \times I_F^2 R$).

Note: A factor of 2 (marked with an asterisk) is applied because the permissible wattage of the resistor must be twice as large as the required wattage.

LED Characteristics ($V_F - I_F$ Characteristics)

T_a : Ambient Temperature

Red

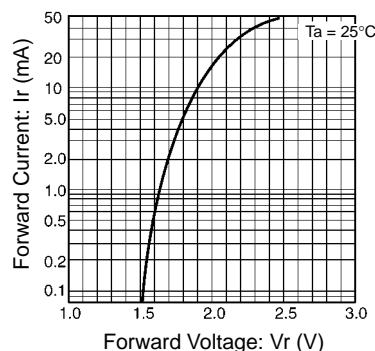

Green

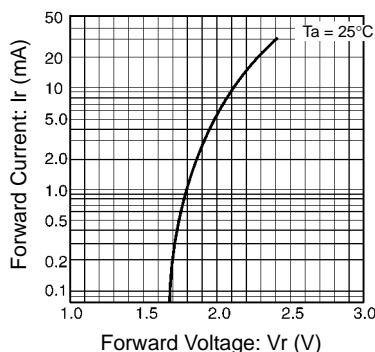

Yellow

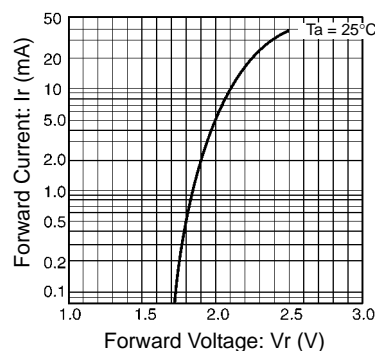

Pushbutton

When exchanging the Pushbutton (except the ones for the mechanical indicator models) with a new one, pull out the Pushbutton from the Switch, holding the Pushbutton in the longitudinal direction.

Do not remove the Pushbutton of the mechanical indicator model.

Engraving of Pushbutton

Depth of engraving:

0.3 mm max. for illuminating pushbutton

Since the Pushbutton is made of polycarbonate, use an alcohol-based solvent when cleaning the Unit.

Pressing of Pushbutton

Apply firm pressure to the Pushbutton when operating it. In doing so, however, do not apply a pressure greater than 11.8 N.

ALL DIMENSIONS SHOWN ARE IN MILLIMETERS.

To convert millimeters into inches, multiply by 0.03937. To convert grams into ounces, multiply by 0.03527.