

Distinctive Characteristics

Square or rectangular models.

Combination of PCB mountability and short body allows use in compact applications.

Small behind panel dimension for snap-in mounting in tight spaces.

Snap-acting contact mechanism provides sensitive actuation with audible feedback; quick-make, quick-break characteristic limits arcing and prolongs electrical life.

Latchdown mechanism, independent of switching mechanism, gives visible and tactile indication of circuit status.

Terminals are epoxy sealed to lock out flux, solvents, and other contaminants.

Momentary and alternate action circuits available in the same space-saving body size.

Illuminated models available and shown in Illuminated Pushbutton section.

Matching indicators available and shown at the end of Section M.

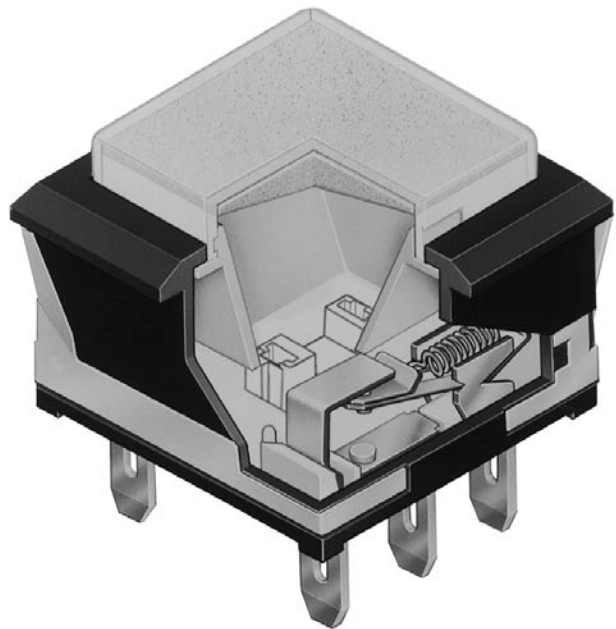

Actual Size

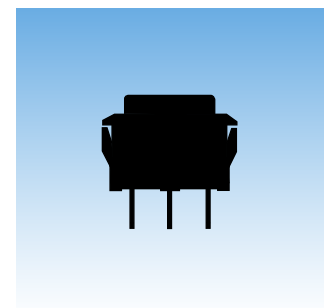

General Specifications

Electrical Capacity (Resistive Load)

Power Level (code W):	5A @ 125/250V AC or 5A @ 30V DC
Logic Level (code G):	0.4VA maximum @ 28V AC/DC maximum (Applicable Range 0.1mA ~ 0.1A @ 20mV ~ 28V) Note: Find additional explanation of operating range in Supplement section.

Other Ratings

Contact Resistance:	50 milliohms maximum for silver; 100 milliohms maximum for gold
Insulation Resistance:	200 megohms minimum @ 500V DC
Dielectric Strength:	1,000V AC minimum between contacts for 1 minute minimum; 1,500V AC minimum between contacts & case for 1 minute minimum
Mechanical Life:	1,000,000 operations minimum for momentary; 200,000 operations minimum for alternate action
Electrical Life:	10,000 operations minimum for silver; 100,000 operations minimum for silver with resistive load of 3A @ 125V AC 200,000 operations minimum for gold
Nominal Operating Force:	Single Pole: 1.57N for Square & 1.9N for Rectangular Double Pole: 2.55N for Square & 3.1N for Rectangular
Contact Timing:	Break before make
Travel:	Pretravel .067" (1.7mm); Overtravel .024" (0.6mm); Total Travel .091" (2.3mm)

Materials & Finishes

Housing/Bezel:	Glass fiber reinforced polyamide (UL94V-0)
Snap-in Frame:	Stainless steel
Movable Contactor:	Phosphor bronze
Movable Contacts:	Silver alloy or copper with gold plating
Stationary Contacts:	Silver alloy or copper with gold plating
Terminals:	Phosphor bronze with silver or gold plating
Base:	Glass fiber reinforced liquid crystal polymer (UL94V-0)

Environmental Data

Operating Temp Range:	-20°C through +70°C (-4°F through +158°F)
Humidity:	90 ~ 95% humidity for 96 hours @ 40°C (104°F)
Vibration:	10 ~ 55Hz with peak-to-peak amplitude of 1.5mm traversing the frequency range & returning in 1 minute; 3 right angled directions for 2 hours
Shock:	50G (490m/s ²) acceleration (tested in 6 right angled directions, with 5 shocks in each direction)

Installation

Cap Installation Force:	7.55N (1.70 lbf) maximum downward force on cap
Soldering Time & Temp:	Wave Soldering (PC version): See Profile A in Supplement section. Manual Soldering: See Profile A in Supplement section.
Cleaning:	These devices are not process sealed. Hand clean locally using alcohol based solution.

Standards & Certifications

Flammability Standards:	UL94V-0 housing/bezel of GFR polyamide & base of GFR liquid crystal polymer
UL & C-UL Recognized:	All single & double pole models recognized at 5A @ 125/250V AC or 0.014A @ 28V DC; UL File No. WOYR2.E44145; add "/U" to end of part number to order UL mark on switch; C-UL File No. WOYR8.E44145; add "/C-UL" to end of part number to order C-UL mark on switch.
CSA Certified:	All single & double pole models certified at 5A @ 125/250V AC or 5A @ 30V DC or 0.4VA maximum @ 28V AC/DC maximum; CSA File No. 023535-0-000; add "/C" to end of part number to order CSA mark on switch.



TYPICAL SWITCH ORDERING EXAMPLE

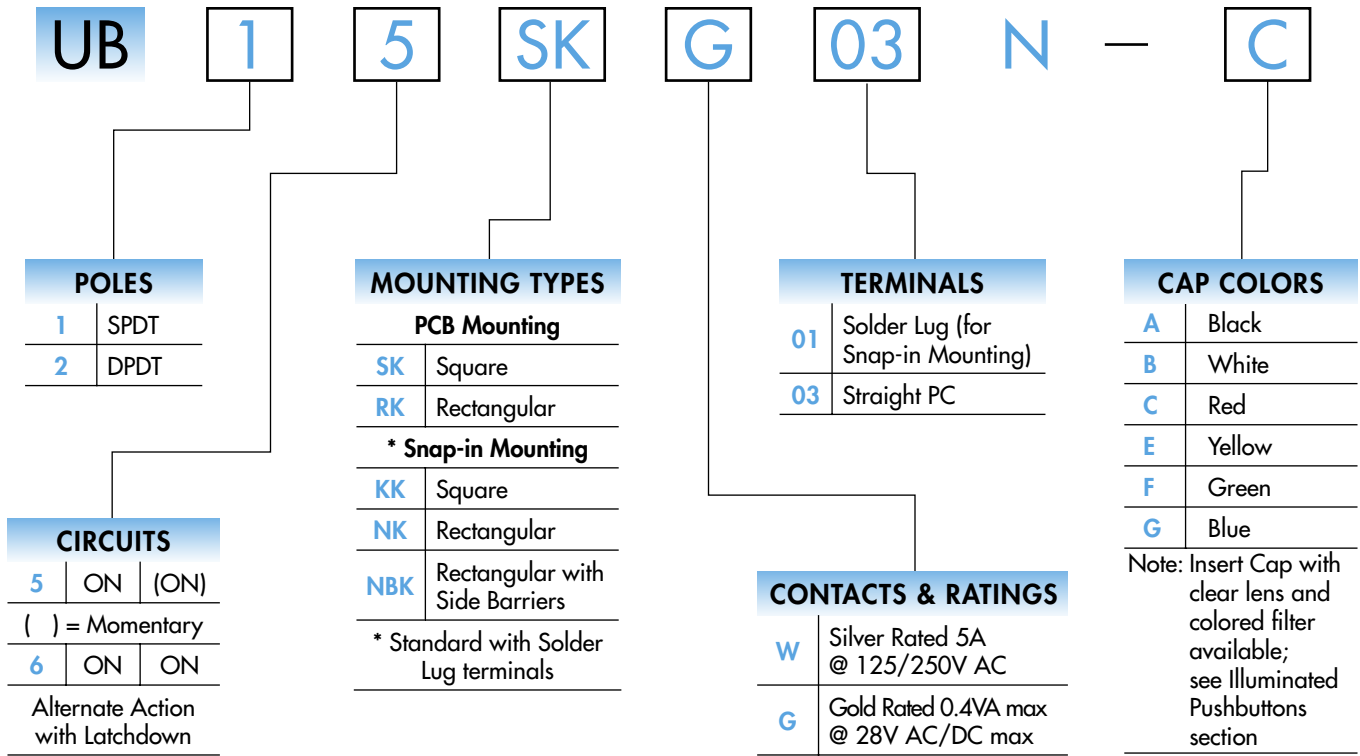

DESCRIPTION FOR TYPICAL ORDERING EXAMPLE

UB15SKG03N-C

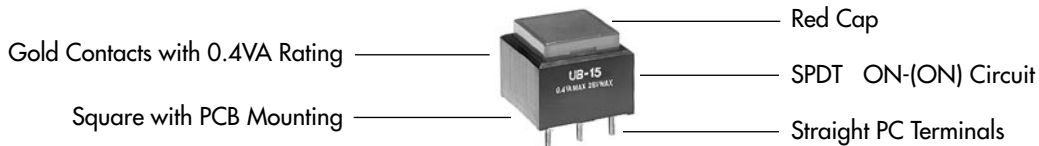

IMPORTANT:



Switches are supplied without UL, C-UL, & CSA markings unless specified. Specific models & ratings noted on General Specifications page.

POLES & CIRCUITS

Pole	Model	Plunger Position () = Momentary		Connected Terminals		Throw & Schematics
		Normal	Down	Normal	Down	
SP	UB15 *UB16	ON ON	(ON) ON	1-3 1-2		SPDT
DP	UB25 *UB26	ON ON	(ON) ON	1-3 4-6 1-2 4-5		DPDT

* When in latchdown position for the alternate circuit, cap position is .039" (1.0mm) above the housing.

MOUNTING TYPES & SHAPES

PCB Mounting

SK

Square

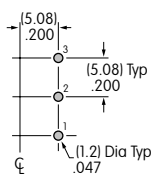
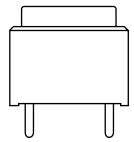

Single Pole

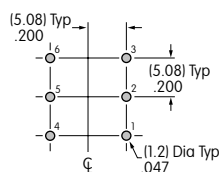

Double Pole

RK

Rectangular

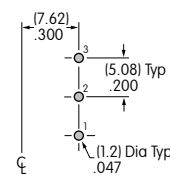
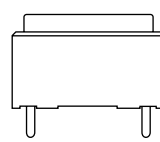

Single Pole

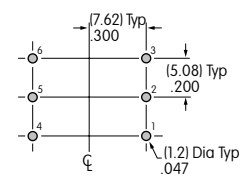

Double Pole

Snap-in Mounting (Solder Lug)

KK

Square with Built-in Bezel

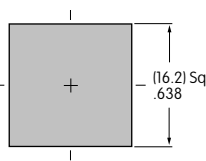
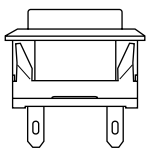

NK

Rectangular with Built-in Bezel

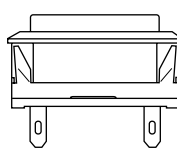

NBK

Rectangular with Built-in Side Barriers

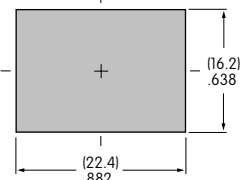
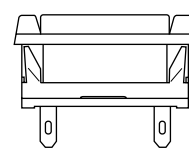

Snap-in Mounting with Solder Lug terminals is the standard combination. Panel Thickness: .039 ~ .126" (1.0 ~ 3.2mm)

CONTACT MATERIALS & RATINGS

W

Silver Contacts

Power Level

5A @ 125V AC & 250V AC

G

Gold Contacts

Logic Level

0.4VA maximum @ 28V AC/DC maximum

Complete explanation of operating range in Supplement section.

TERMINALS

01

Solder Lug

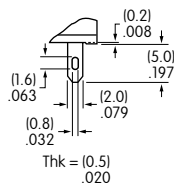

03

Straight PC

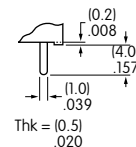

CAPS & COLORS

Colors Available:

A	Black	E	Yellow
B	White	F	Green
C	Red	G	Blue

AT4073 Square
Opaque

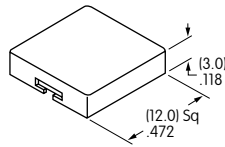

AT4116 Rectangular
Opaque

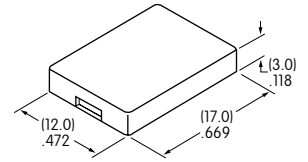

Material: Polycarbonate Finish: Glossy

TYPICAL SWITCH DIMENSIONS

Square • PCB Mount

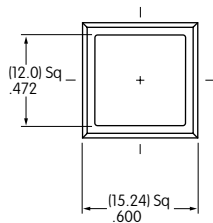

Single & Double Pole

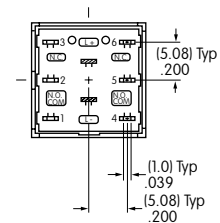
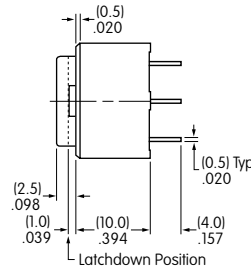

UB15SKG03N-C

Single pole models do not have terminals 4, 5, & 6.

Rectangular • PCB Mount

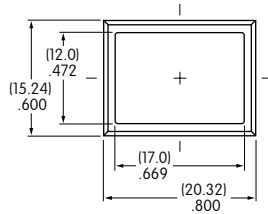

Single & Double Pole

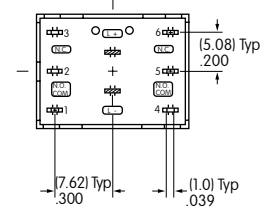
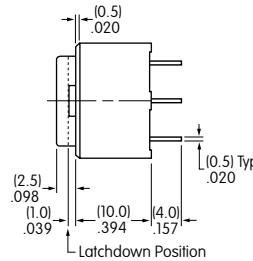

UB26RKG03N-E

Single pole models do not have terminals 4, 5, & 6.

Square • Snap-in Mount • Built-in Bezel

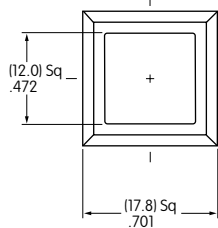

Single & Double Pole

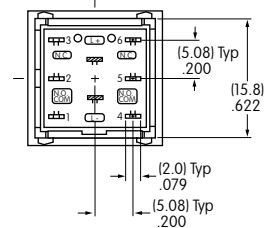
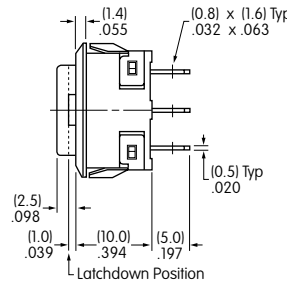

UB25KKW01N-C

Single pole models do not have terminals 4, 5, & 6.

Rectangular • Snap-in Mount • Built-in Bezel

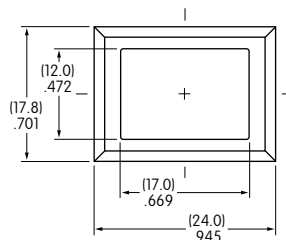

Single & Double Pole

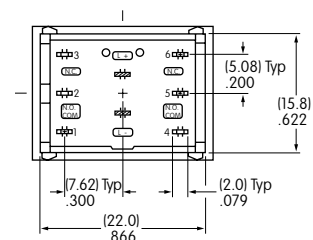
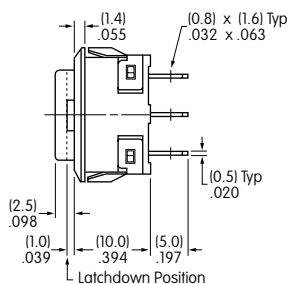

UB26NKW01N-F

Single pole models do not have terminals 4, 5, & 6.

TYPICAL SWITCH DIMENSIONS

Rectangular • Snap-in Mount • Built-in Side Barriers

Single & Double Pole



UB25NBKW01N-F

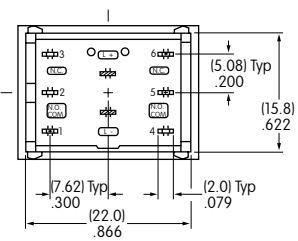
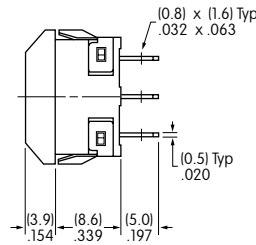
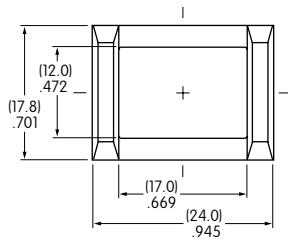

Single pole models do not have terminals 4, 5, & 6.

OPTIONAL ACCESSORIES

AT4001
Square
Dust Cover

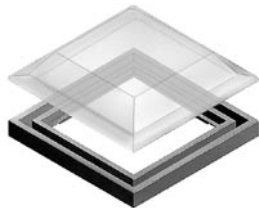

AT4011
Rectangular
Dust Cover

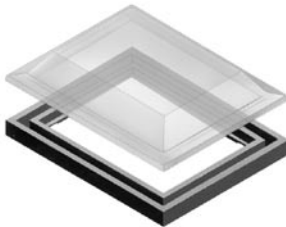

Not for use with barrier type models (mounting code NBK)

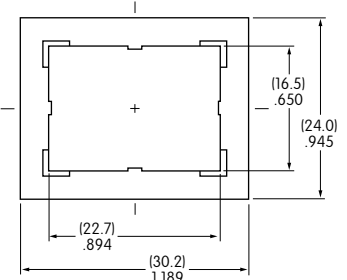
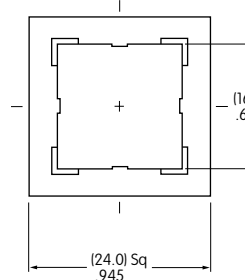
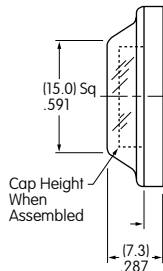

Materials: PVC with polyethylene gasket (PVC loses pliability below 0°C (32°F).)
Recommended Panel Thickness: .039" ~ .098" (1.0mm ~ 2.5mm)

Spring Loaded Protective Guard for Snap-in Mounting of Square PCB Model

AT4173
Square Protective Guard/
Snap-in Frame

Opens 180°
Closes automatically

Materials:
Cover: Clear Polycarbonate
Base: Black Polyamide
Coil Spring: Stainless Steel

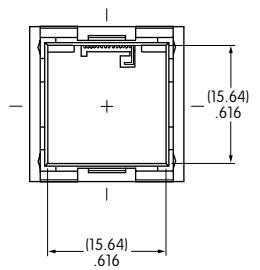
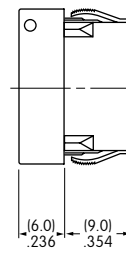
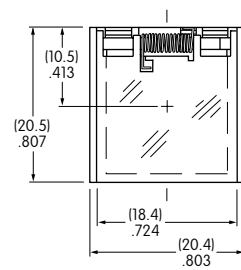

Recommended
Panel Thickness:
.039" ~ .126"
(1.0mm ~ 3.2mm)

Recommended
Panel-to-PCB Range:
.354" ~ .433"
(9.0mm ~ 11.0mm)

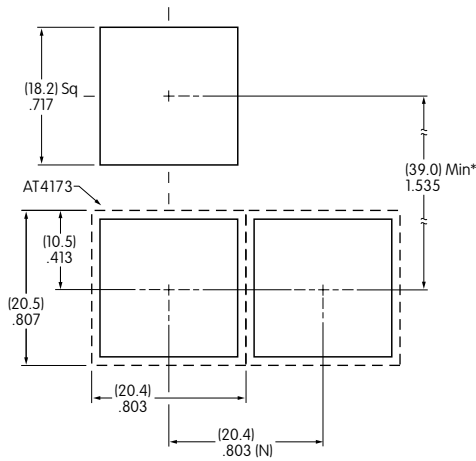
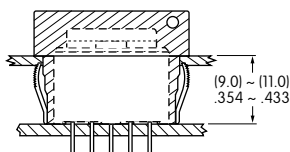

(N) = Number of switches
* Minimum dimension allows opening of cover to 180°

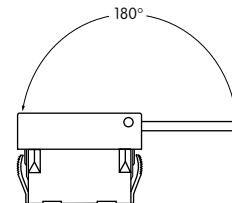

Installation

- ① Install switch onto PC board.
- ② Snap protective guard into panel.
- ③ Join the two assemblies.

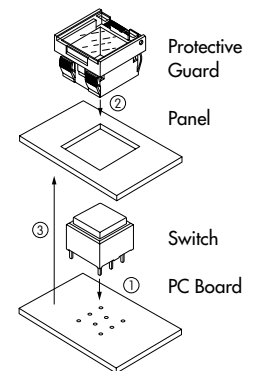

OPTIONAL ACCESSORIES

Spring Loaded Protective Guard for Square Snap-in Model

AT4171 Square Protective Guard

Opens 180°
Closes automatically

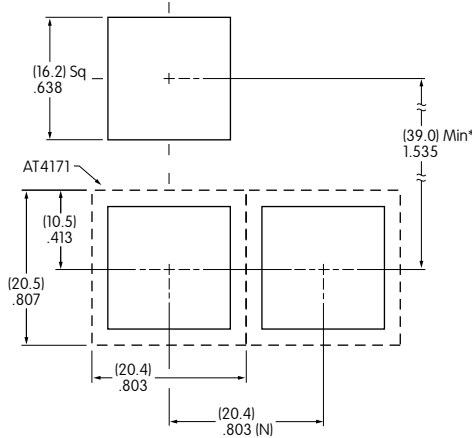
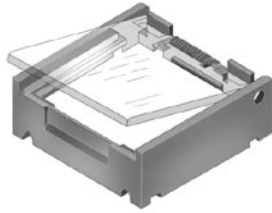

* Minimum dimension allows opening of cover to 180°

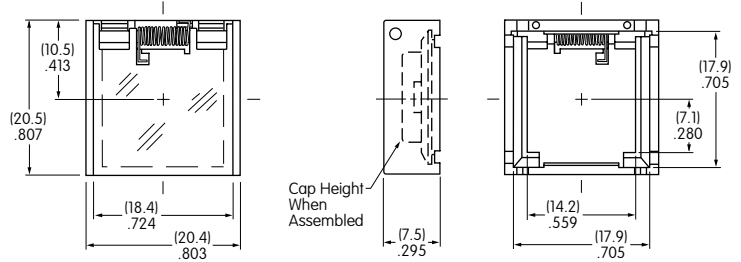

Materials:

Cover: Clear Polycarbonate
Base: Black GFR Polyamide
Coil Spring: Stainless Steel

Recommended Panel Thickness:
.039" ~ .106" (1.0mm ~ 2.7mm)

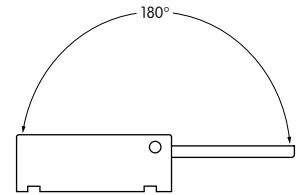

Spring Loaded Protective Guard for Snap-in Mounting of Rectangular PCB Model

AT4174 Rectangular Protective Guard/ Snap-in Frame

Opens 180°
Closes automatically



Materials:
Cover: Clear Polycarbonate
Base: Black Polyamide
Coil Spring: Stainless Steel

Recommended Panel Thickness:
.039" ~ .126"
(1.0mm ~ 3.2mm)

Recommended Panel-to-PCB Range:
.354" ~ .433"
(9.0mm ~ 11.0mm)

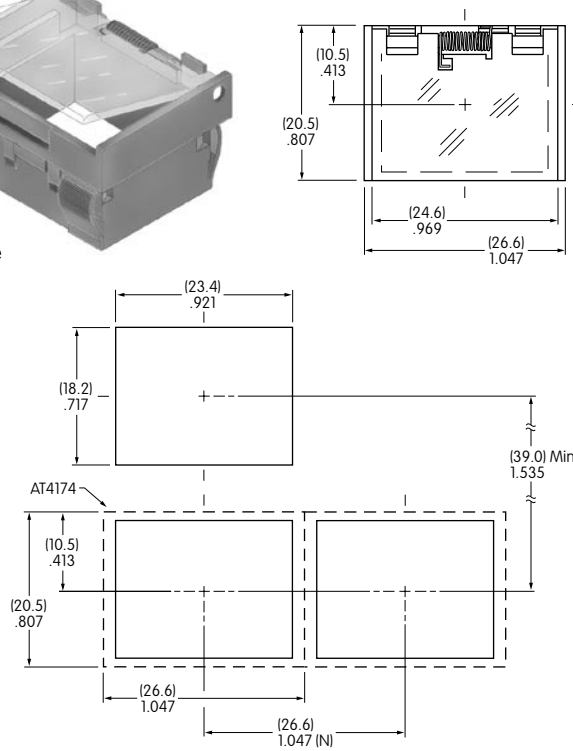
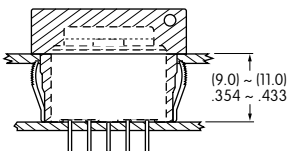

(N) = Number of switches * Minimum dimension allows opening of cover to 180°

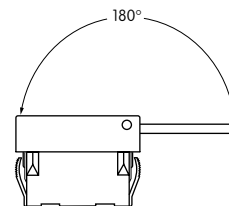
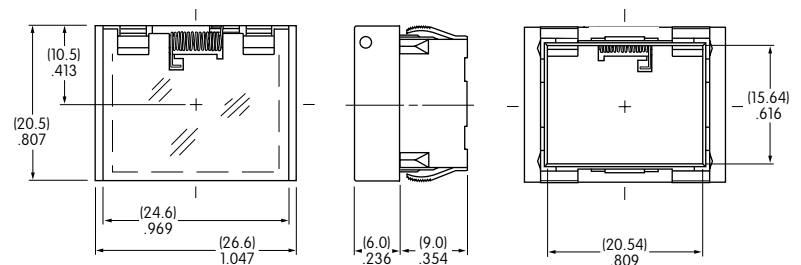

Installation

- ① Install switch onto PC board.
- ② Snap protective guard into panel.
- ③ Join the two assemblies.

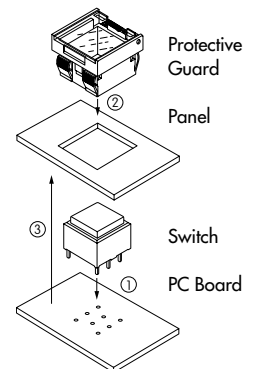

OPTIONAL ACCESSORIES

Spring Loaded Protective Guard for Rectangular Snap-in Model

AT4172 Rectangular Protective Guard

Opens 180°
Closes automatically

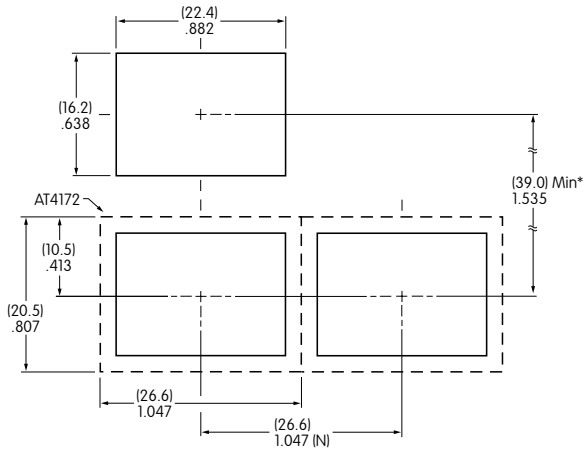
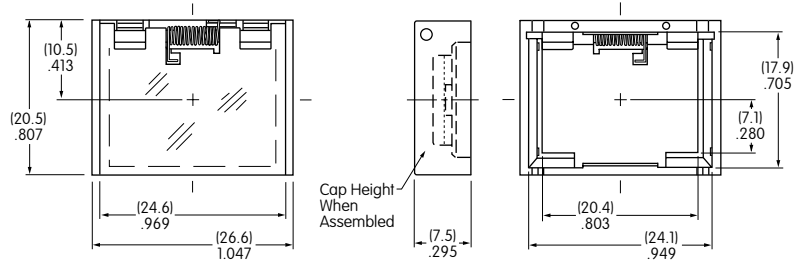

(N) = Number of switches * Minimum dimension allows opening of cover to 180°

Materials:

Cover: Clear Polycarbonate
Base: Black GFR Polyamide
Coil Spring: Stainless Steel

Recommended Panel Thickness:

.039" ~ .106" (1.0mm ~ 2.7mm)

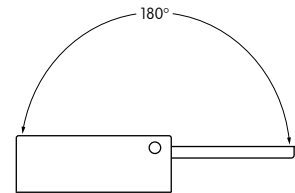

LEGENDS

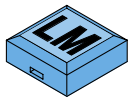

Easily create and submit your own legends using our new on-line Legend Maker.

Visit www.nkkswitches.com

For other legend support options, customers may either contact the factory and request the UB/UB2 Legend Packet, or utilize the general information and basic specifications presented below.

Suggested Printable Area for UB Lens

Recommended Methods: Laser Etch on clear lens; Screen Print or Pad Print on lens.
Epoxy based ink is recommended.

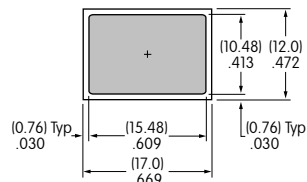
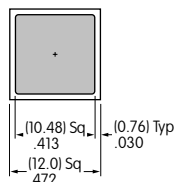

Shaded areas are printable areas.