

TYPICAL INDICATOR ORDERING EXAMPLE

YB **04** **K** **W01** — **12** — **FB**

SHAPES

Bushing Mounting	
01	Square
02	Round
03	Rectangular
Snap-in Mounting	
04	Square
05	Round
06	Rectangular

PANEL SEAL

No Code	Without Panel Seal
W	With Panel Seal (Bushing Mount only)

HOUSING

K Black only

TERMINALS

W01 Silver Solder Lug/.110" (2.8mm) Quick Connect

LAMPS

Incandescent Lamp	
05	5-volt
12	12-volt

Bright LED

LED Colors		Resistor	
5C	Red	No Code	No Resistor
5D	Amber	05	5-volt
5F	Green	12	12-volt
		24	24-volt

Super Bright LED

6B	White
6F	Green
6G	Blue

Bicolor LED

LED Colors		Forward Voltage	
2CF	Red/Green	02	2-volt (no resistor)
		05	5-volt
		12	12-volt
		24	24-volt

CAP TYPES & COLORS

Solid Cap: Lens/Insert Colors	
BB	White/White
CB	Red/White
EB	Yellow/White
FB	Green/White
GB	Blue/White

LED Cap: Lens/Insert Colors

JB	Clear/White
JC	Clear/Red
JD	Clear/Amber
JF	Clear/Green

LED Cap: Lens/Insert Colors

JB	Clear/White
----	-------------

LED Cap: Lens/Insert Colors

JB	Clear/White
----	-------------

DESCRIPTION FOR TYPICAL ORDERING EXAMPLE

YB04KW01-12-FB



SHAPES & MOUNTING TYPES

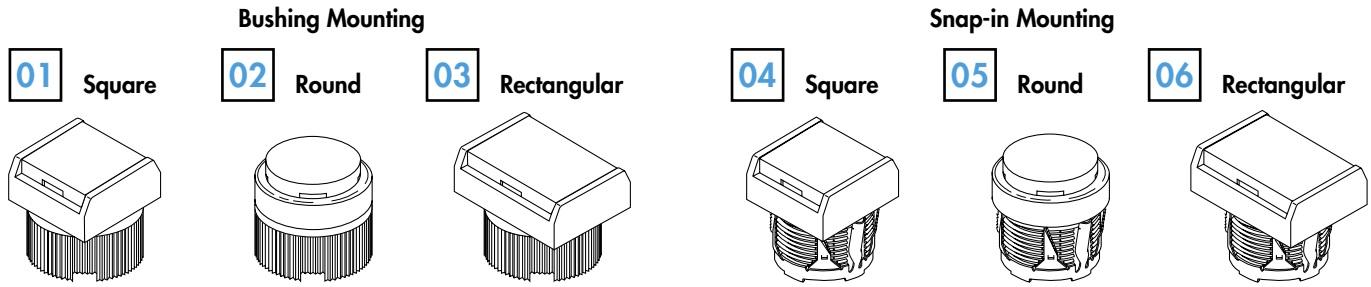

Bezel-barrier is an integral part of the indicator body.

PANEL SEAL

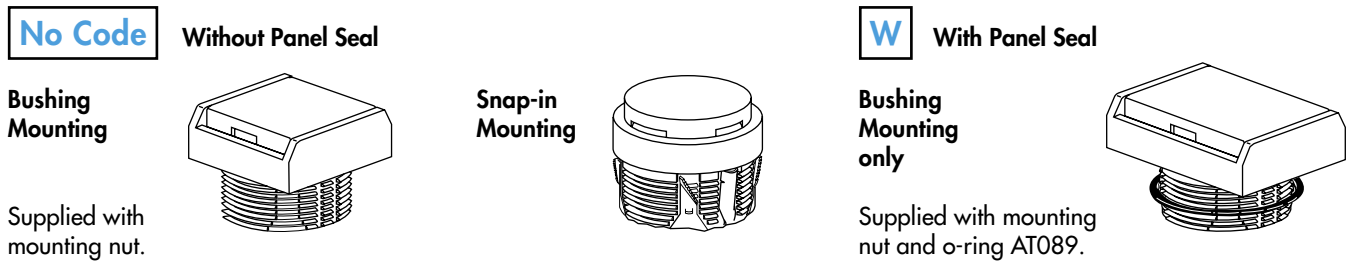

INCANDESCENT LAMP & SOLID CAP

The electrical specifications shown are determined at a basic temperature of 25°C.
If the source voltage exceeds the rated voltage, a ballast resistor is required.
The resistor value can be calculated by using the formula in the Supplement section.

AT611  T-1 Bi-pin		05	12	
	Voltage	V	5V AC	12V AC
	Current	I	115mA	60mA
	MSCP		.150	.150
	Endurance	Hours	7,000 average	
	Ambient Temperature Range		-25°C ~ +50°C	

Solid Cap for Incandescent Lamp

Lens/Insert
Colors Available:

- BB** White/White
- CB** Red/White
- EB** Yellow/White
- FB** Green/White
- GB** Blue/White

Materials: Polycarbonate (Lens & Insert)
Thermoplastic Elastomer (Seal/Filter)
Finish: Glossy

AT3001
Square

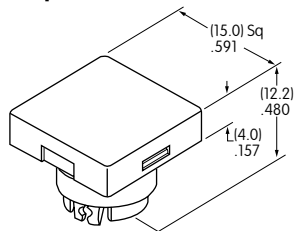

AT3003
Rectangular

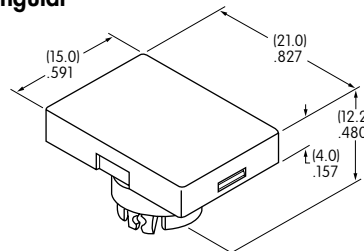

AT3002
Round

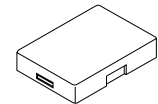
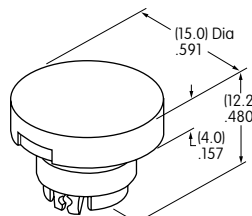

Translucent Colored Lens



Translucent White Insert

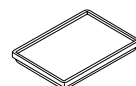

Translucent White Seal/Filter



Incandescent Lamp AT611

BRIGHT LEDS & LED CAPS

The electrical specifications shown are determined at a basic temperature of 25°C.
 If the source voltage exceeds the rated voltage, a ballast resistor is required.
 The resistor value can be calculated by using the formula in the Supplement section.

Electrical Specifications for Bright LED without Resistor

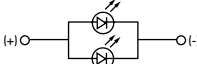
Bright AT628   T-1 Bi-pin	Colors Available: 5C Red 5D Amber 5F Green No Code No Resistor	Unit				
	Forward Peak Current	I_{FM}	40	40	40	mA
	Continuous Forward Current	I_F	26	26	26	mA
	Forward Voltage	V_F	1.9	2.0	2.2	V
	Reverse Peak Voltage	V_{RM}	4	4	4	V
	Current Reduction Rate Above 25°C	ΔI_F	0.50			mA/°C
	Ambient Temperature Range	-25 ~ +50			°C	

Electrical Specifications for Bright LED with Resistor

Bright AT634  T-1 1/4 Bi-pin	Colors Available: 5C Red 5D Amber 5F Green 05 12 24	Unit				
	Forward Peak Current	I_{FM}	—	—	—	mA
	Continuous Forward Current	I_F	25	20	10	mA
	Forward Voltage	V_F	5	12	24	V
	Reverse Peak Voltage	V_{RM}	4	8	16	V
	Current Reduction Rate Above 25°C	ΔI_F	—	—	—	mA/°C
	Ambient Temperature Range	-25 ~ +50			°C	

AT634
5-volt,
2-element
with Resistor

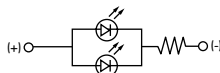

AT634
12-volt,
4-element
with Resistor

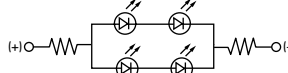

AT634
24-volt,
4-element
with Resistor

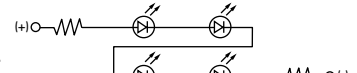

Cap for Bright LED

Lens/Insert
Colors Available:

- JB Clear/White
- JC Clear/Red
- JD Clear/Amber
- JF Clear/Green

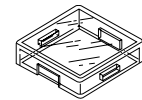
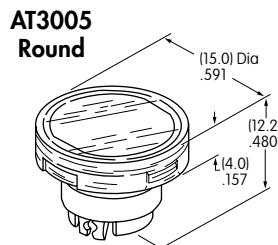
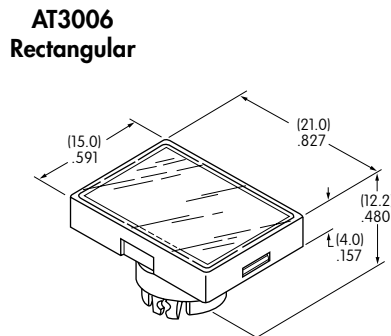
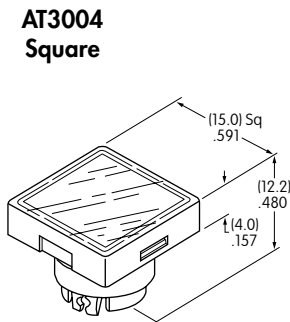

Transparent Clear Lens

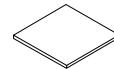

Translucent Colored Insert

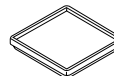

Translucent White Seal/Diffuser



Bright LEDs
AT628 AT634

Materials: Polycarbonate (Lens & Insert)
 Thermoplastic Elastomer (Seal/Diffuser)
 Finish: Glossy

SUPER BRIGHT LEDs & LED CAPS

The electrical specifications shown are determined at a basic temperature of 25°C.
 If the source voltage exceeds the rated voltage, a ballast resistor is required.
 The resistor value can be calculated by using the formula in the Supplement section.

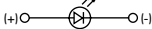
Super Bright AT625G Blue AT631B White AT632F Green			<div style="border: 1px solid black; padding: 2px; display: inline-block;">6B</div>	<div style="border: 1px solid black; padding: 2px; display: inline-block;">6F</div>	<div style="border: 1px solid black; padding: 2px; display: inline-block;">6G</div>			
			Colors:	White	Green	Blue	Unit	
			Forward Peak Current	I_{FM}	30	30	30	mA
			Continuous Forward Current	I_F	20	20	20	mA
			Forward Voltage	V_F	3.6	3.5	3.6	V
			Reverse Peak Voltage	V_{RM}	5	5	5	V
			Current Reduction Rate Above 25°C	ΔI_F	0.50			mA/°C
Ambient Temperature Range		-25 ~ +50			°C			



T-1 Bi-pin

Cap for Super Bright LED

AT3014
Square

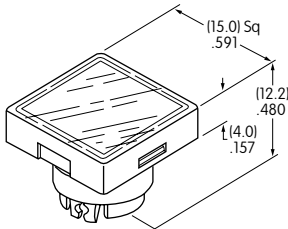

AT3015
Round

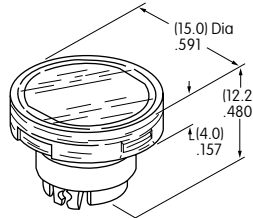

AT3016
Rectangular

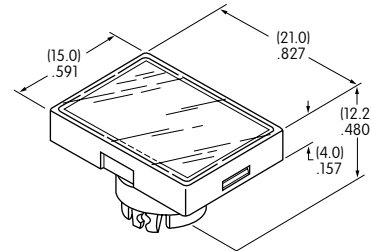

Lens/Insert
Colors Available:

JB Clear/White

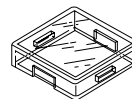

Transparent Clear Lens

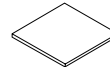

Translucent White Insert

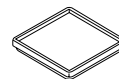

Translucent White Seal/Diffuser





Super Bright LEDs
AT625 AT631
AT632

Materials: Polycarbonate (Lens & Insert)
Thermoplastic Elastomer (Seal/Diffuser)

BICOLOR LED & LED CAPS

The electrical specifications shown are determined at a basic temperature of 25°C.
 If the source voltage exceeds the rated voltage, a ballast resistor is required.
 The resistor value can be calculated by using the formula in the Supplement section.

Bicolor AT621  Red/Green  T-1 1/2 Bi-pin	Bicolor LED is translucent white in OFF state.	02	05	12	24	Unit	
	Forward Peak Current	I_{FM}	60	60	20	12	mA
	Continuous Forward Current	I_F	45	45	15	10	mA
	Forward Voltage	V_F	2.1	5	12	24	V
	Current Reduction Rate Above 25°C	ΔI_F	0.80	----	----	----	mA/°C
	Ambient Temperature Range		-25 ~ +50				°C

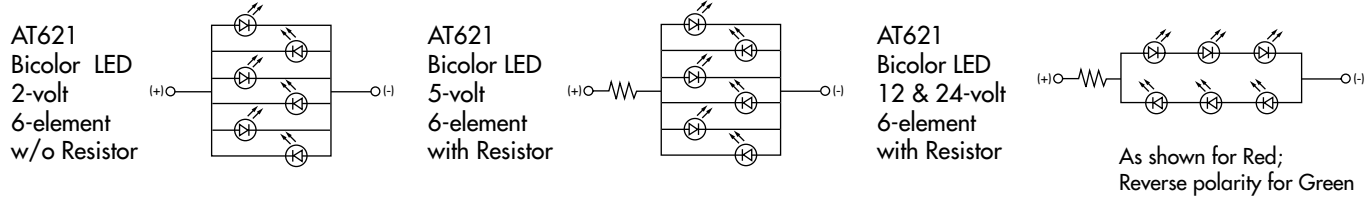

LED Caps

AT3004 Square

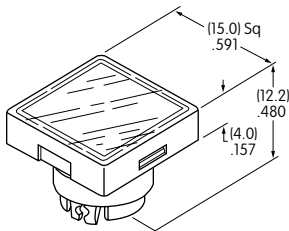

AT3005 Round

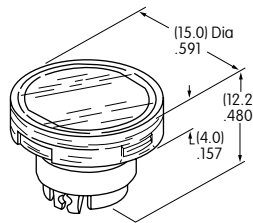

AT3006 Rectangular

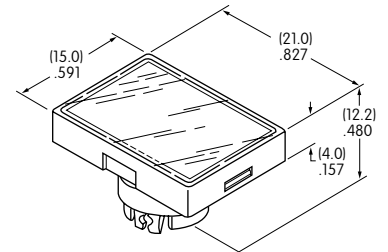

Lens/Insert
 Colors Available:

JB Clear/White

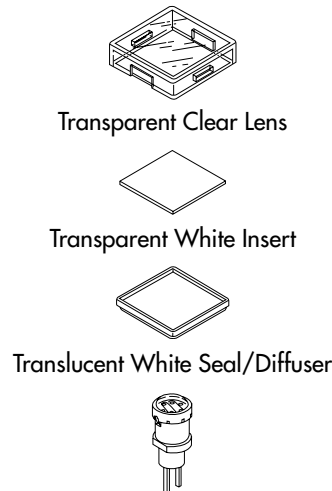

Materials: Polycarbonate (Lens & Insert)
 Thermoplastic Elastomer (Seal/Diffuser)

TYPICAL SWITCH DIMENSIONS

Square • Bushing Mounting

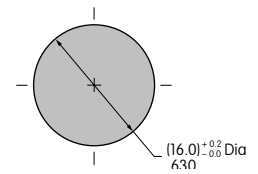
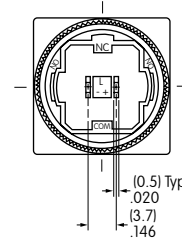
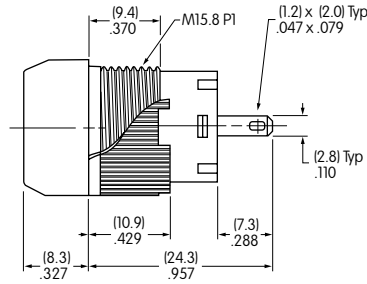
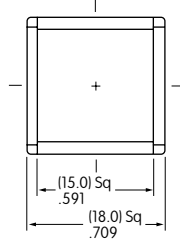

Panel Thickness

.020" ~ .197" (0.5mm ~ 5.0mm)

YB01KW01-12-CB

Round • Panel Seal

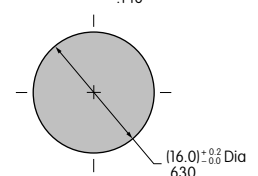
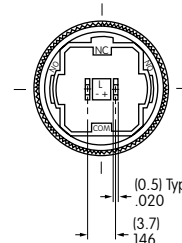
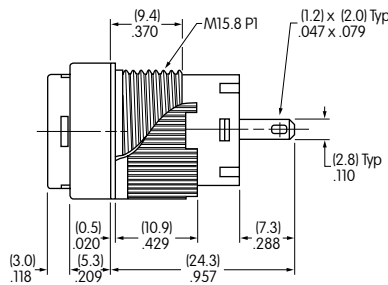
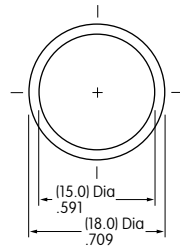

Panel Thickness

.020" ~ .197" (0.5mm ~ 5.0mm)

YB02WKW01-12-CB

Rectangular • Snap-in Mounting

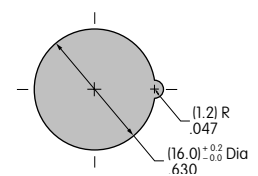
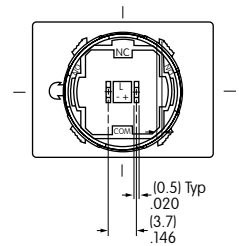
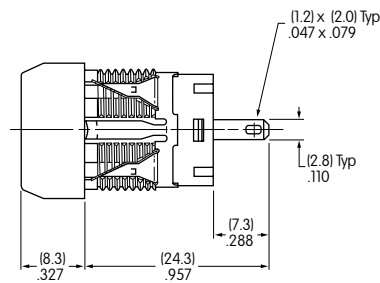
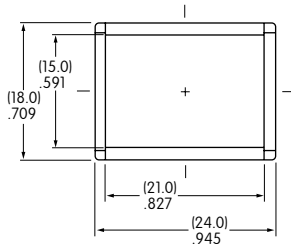

Panel Thickness

.039" ~ .138" (1.0mm ~ 3.5mm)

YB06KW01-12-CB