

Pushbutton Switches, Panel Mount, Wire Lug or PC Tails, 6 Amp

MATERIAL SPECIFICATIONS:

ContactsSilver clad copper with gold flash
Case Material.....Thermoset
Actuator MaterialNickel plated copper alloy
Terminals.....Copper with gold flash
Terminal SealMolded in

ENVIRONMENTAL SPECIFICATIONS:

Operating Temperature-4°F to +176°F (-20°C to +80°C)
Storage Temperature-40°F to +176°F (-40°C to +80°C)
Solder Heat ResistanceSee page M3-4

Note: Hardware included with switches

TYPICAL PERFORMANCE CHARACTERISTICS:

Contact Rating.....6 A @ 125 VAC, 3 A @ 250 VAC
Initial Contact Resistance10 Milliohms max.
Contact TimingBreak-before-make
Insulation Resistance.....1,000 Megohms min.
Dielectric Strength.....1,500 Volts RMS @ sea level
Actuation Force1.3 to 2.7 lbs.
Actuator Travel140" (3.56)

Life Expectancy.....Up to 50,000 Actuations
Cap not supplied, order separately
(See Cap Model C22 and C23 on page D32.)

SPDT



MPA106D

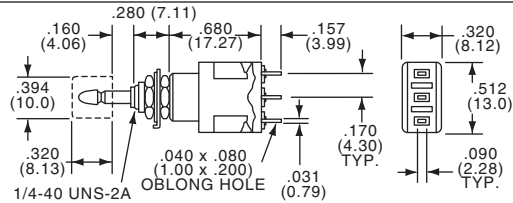
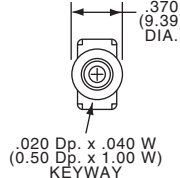
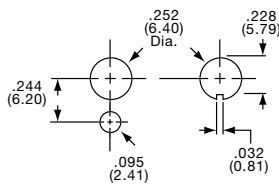

Part Number					
Tyco Electronics	Alcoswitch	Type	Act. Code	P. M6	Action
2-1437567-8	MPA106D	SPDT	23		Push-on/Push-off
2-1437567-9	MPA106F	SPDT	19		Momentary

DPDT



MPA206N

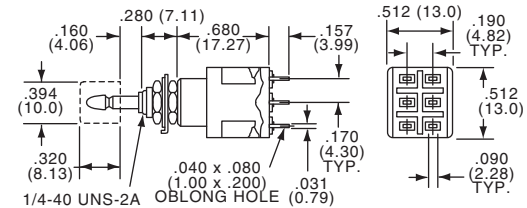
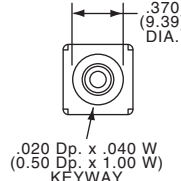
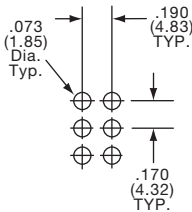

Part Number					
Tyco Electronics	Alcoswitch	Type	Act. Code	P. M6	Action
Wirelug Terminals					
3-1437567-1	MPA206N	DPDT	24		Push-on/Push-off
3-1437567-3	MPA206R	DPDT	20		Momentary

Part Number					
Tyco Electronics	Alcoswitch	Type	Act. Code	P. M6	Action
PC Terminals					
3-1437567-2	MPA206NPC	DPDT	24		Push-on/Push-off
3-1437567-4	MPA206RPC	DPDT	20		Momentary

3PDT



MPA306D

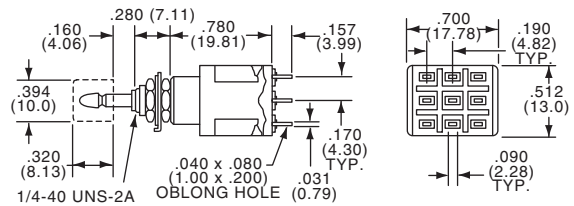
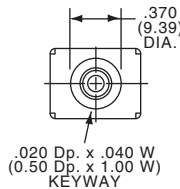
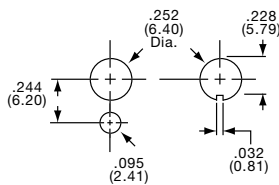

Part Number					
Tyco Electronics	Alcoswitch	Type	Act. Code	P. M6	Action
3-1437567-5	MPA306D	3PDT	25		Push-on/Push-off
3-1437567-6	MPA306F	3PDT	21		Momentary

4PDT



MPA406N

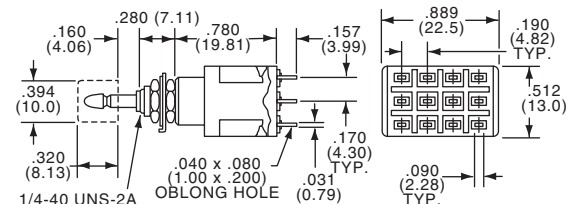
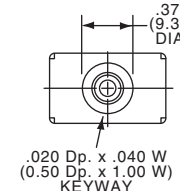
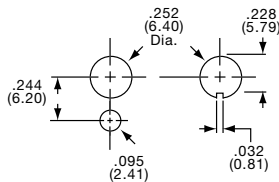

Part Number					
Tyco Electronics	Alcoswitch	Type	Act. Code	P. M6	Action
3-1437567-7	MPA406N	4PDT	26		Push-on/Push-off
3-1437567-8	MPA406R	4PDT	22		Momentary

Pushbutton Switches, Splashproof, Panel Mount, Wire Lug, 6 Amp

MATERIAL SPECIFICATIONS:

ContactsSilver clad copper with gold flash
Case MaterialThermoset
Actuator MaterialNickel plated copper alloy
TerminalsCopper with gold flash
Terminal SealMolded in

ENVIRONMENTAL SPECIFICATIONS:

Operating Temperature-4°F to +176°F (-20°C to +80°C)
Storage Temperature-40°F to +176°F (-40°C to +80°C)
Note: Hardware included with switches

TYPICAL PERFORMANCE CHARACTERISTICS:

Contact Rating6 A @ 125 VAC, 3 A @ 250 VAC
Initial Contact Resistance10 Milliohms max.
Contact TimingBreak-before-make
Insulation Resistance1,000 Megohms min.
Dielectric Strength1,500 Volts RMS @ sea level
Actuation Force1.3 to 2.7 lbs.
Actuator Travel140" (3.56)
Life ExpectancyUp to 50,000 Actuations

Notice: O-ring on shoulder and inside moveable shaft provides splashproof seal. Meets IP65

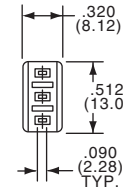
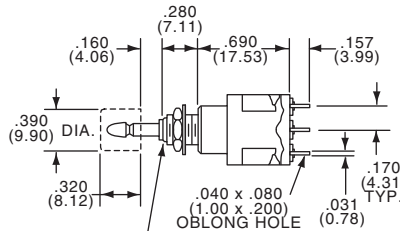
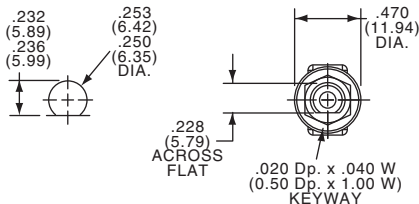

SPDT



MPE106D

Part Number		Act. Code		
Tyco Electronics	Alcoswitch	Type	P. M6	Action
4-1437567-2	MPE106D	SPDT	23	Push on/Push off
4-1437567-3	MPE106F	SPDT	19	Momentary

1/4-40 UNS-2A

Cap not supplied, order separately (See Cap Model C22 and C23 on page D32.)

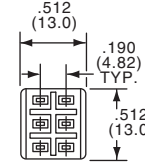
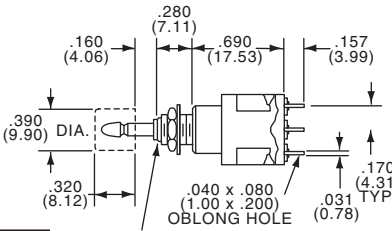
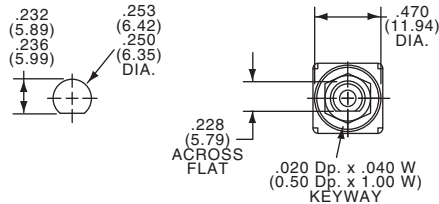

DPDT



MPE206N

Part Number		Act. Code		
Tyco Electronics	Alcoswitch	Type	P. M6	Action
4-1437567-4	MPE206N	DPDT	24	Push on/Push off
4-1437567-5	MPE206R	DPDT	20	Momentary

1/4-40 UNS-2A

Cap not supplied, order separately (See Cap Model C22 and C23 on page D32.)

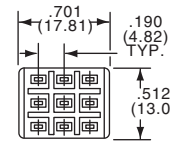
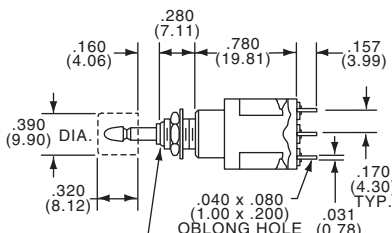
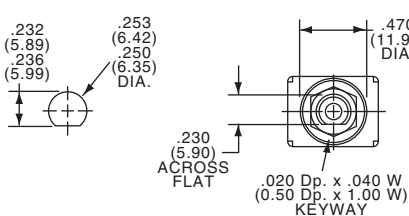

3PDT



MPE306F

Part Number		Act. Code		
Tyco Electronics	Alcoswitch	Type	P. M6	Action
—	MPE306D	3PDT	25	Push on/Push off
4-1437567-6	MPE306F	3PDT	21	Momentary

1/4-40 UNS-2A

Cap not supplied, order separately (See Cap Model C22 and C23 on page D32.)

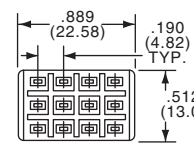
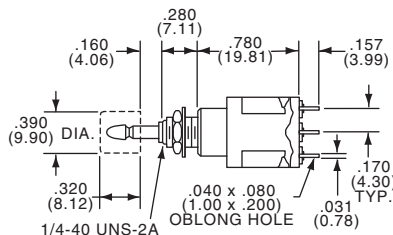
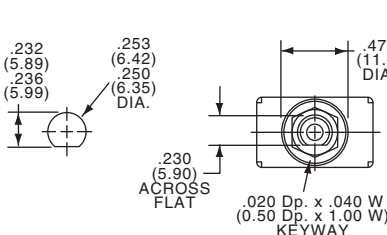

4PDT



MPE406N

Part Number		Act. Code		
Tyco Electronics	Alcoswitch	Type	P. M6	Action
4-1437567-7	MPE406N	4PDT	26	Push on/Push off
4-1437567-8	MPE406R	4PDT	22	Momentary

1/4-40 UNS-2A

Cap not supplied, order separately (See Cap Model C22 and C23 on page D32.)

Pushbutton Switches, 15/32 Bushing, Mustang, Wire Lug or PC Tails, 6 Amp

MATERIAL SPECIFICATIONS:

ContactsSilver clad copper with gold flash
 Case MaterialThermoset
 TerminalsCopper with gold flash finish
 Terminal SealMolded in

TYPICAL PERFORMANCE CHARACTERISTICS:

Contact Rating6 A @ 125 VAC, 3 A @ 250 VAC
 Initial Contact Resistance10 Milliohms max.
 Contact TimingBreak-before-make
 Insulation Resistance1,000 Megohms min.
 Dielectric Strength1,500 Volts RMS @ sea level
 Actuation Force1.3 to 2.7 lbs.
 Actuator Travel138" (3.51)
 Life ExpectancyUp to 50,000 Actuations
 Note: Hardware included with switches

ENVIRONMENTAL SPECIFICATIONS:

Operating Temperature.....-4°F to +176°F (-20°C to +80°C)
 Storage Temperature.....-40F to +176°F (-40°C to +80°C)
 Solder Heat ResistanceSee page M3-4

SPDT

Black Cap supplied.



MPG106D

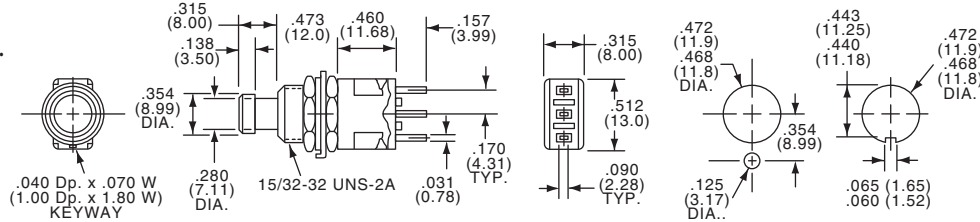

Other Caps Available, order separately
 (See Cap Model C9 on page D32.)

Part Number		Type	Act. Code	P. M6	Action	Terminals	
Tyco Electronics	4-1437567-9	Alcoswitch	MPG106D	SPDT	23	Push on/Push off	Wire Lug
Tyco Electronics	5-1437567-0	Alcoswitch	MPG106F	SPDT	19	Momentary	Wire Lug

DPDT

Black Cap supplied.



MPG206NPC

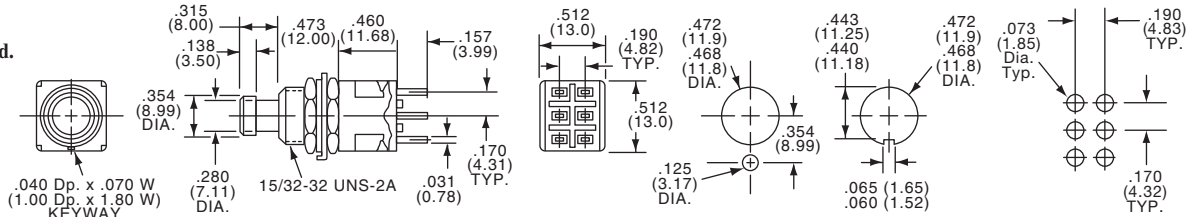

Other Caps Available, order separately
 (See Cap Model C9 on page D32.)

Part Number		Type	Act. Code	P. M6	Action	Terminals	
Tyco Electronics	5-1437567-1	Alcoswitch	MPG206N	DPDT	24	Push on/Push off	Wire Lug
Tyco Electronics	5-1437567-3	Alcoswitch	MPG206R	DPDT	20	Momentary	Wire Lug
Tyco Electronics	5-1437567-2	Alcoswitch	MPG206NPC	DPDT	24	Push on/Push off	PC
Tyco Electronics	5-1437567-4	Alcoswitch	MPG206RPC	DPDT	20	Momentary	PC

3PDT

Black Cap supplied.



MPG306D

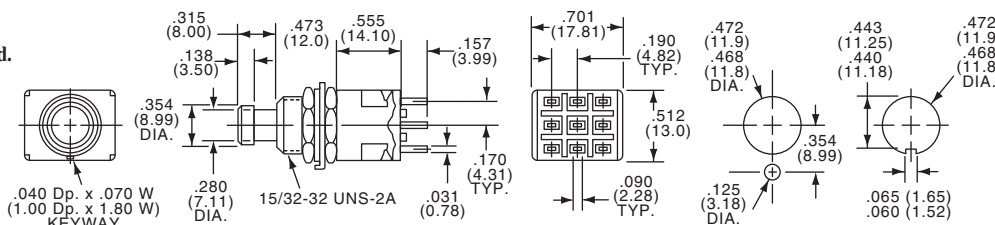

Other Caps Available, order separately
 (See Cap Model C9 on page D32.)

Part Number		Type	Act. Code	P. M6	Action	Terminals	
Tyco Electronics	5-1437567-5	Alcoswitch	MPG306D	3PDT	25	Push on/Push off	Wire Lug
Tyco Electronics	5-1437567-6	Alcoswitch	MPG306F	3PDT	21	Momentary	Wire Lug

4PDT

Black Cap supplied.



MPG406N

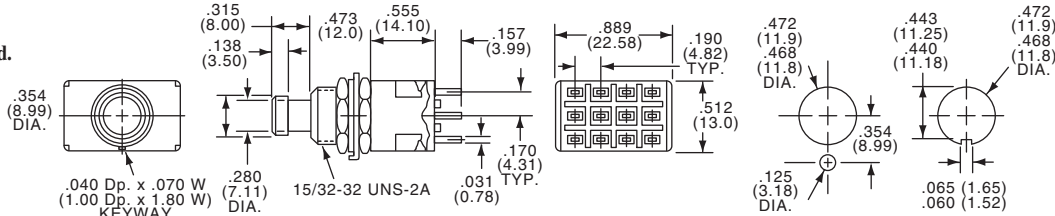

Other Caps Available, order separately
 (See Cap Model C9 on page D32.)

Part Number		Type	Act. Code	P. M6	Action	Terminals	
Tyco Electronics	5-1437567-7	Alcoswitch	MPG406N	4PDT	25	Push on/Push off	Wire Lug
Tyco Electronics	5-1437567-8	Alcoswitch	MPG406R	4PDT	21	Momentary	Wire Lug

Pushbutton Switches, Snap Action, PC or Wire Wrap Tails, 3 Amp

SPDT/DPDT

SEE PAGE D25 FOR PRODUCT SPECIFICATIONS



MPS103FPC



MPS203RPC

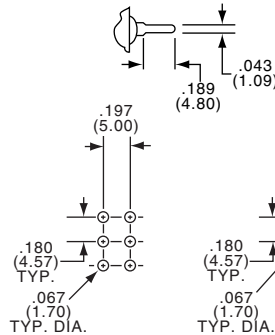
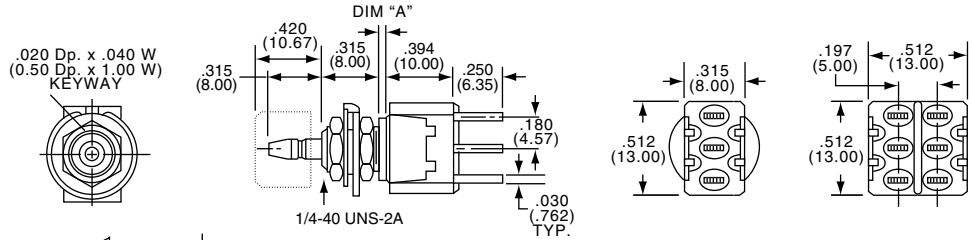

Part Number					
Tyco Electronics	Alcoswitch	Type	Action	Dim."A"	Terminals
6-1437567-0	MPS103DPC	SPDT	Push-on/Off	.100	PC Terminals
6-1437567-4	MPS103FPC	SPDT	Momentary	.040	PC Terminals
6-1437567-9	MPS203NPC	DPDT	Push-on/Off	.100	PC Terminals
7-1437567-3	MPS203RPC	DPDT	Momentary	.040	PC Terminals

Caps not supplied, order separately. (See Cap Model C22 and C23 on Page D32.)

SPDT/DPDT



MPS103FPCV



MPS203RPCV

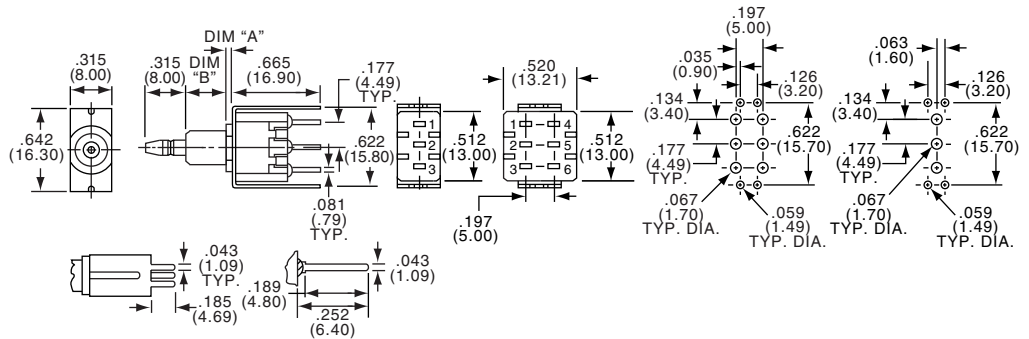

Part Number						
Tyco Electronics	Alcoswitch	Type	Action	Dim."A"	Dim."B"	Terminals
6-1437567-1	MPS103DPCV	SPDT	Push-on/Off	.080(2.03)	.315(8.00)	PC w/support
6-1437567-5	MPS103FPCV	SPDT	Momentary	.040(1.01)	.295(7.49)	PC w/support
7-1437567-4	MPS203RPCV	DPDT	Momentary	.040(1.01)	.295(7.49)	PC w/support

Caps not supplied, order separately. (See Cap Model C22 and C23 on Page D32.)

SPDT/DPDT



MPS103FWW



MPS203RWW

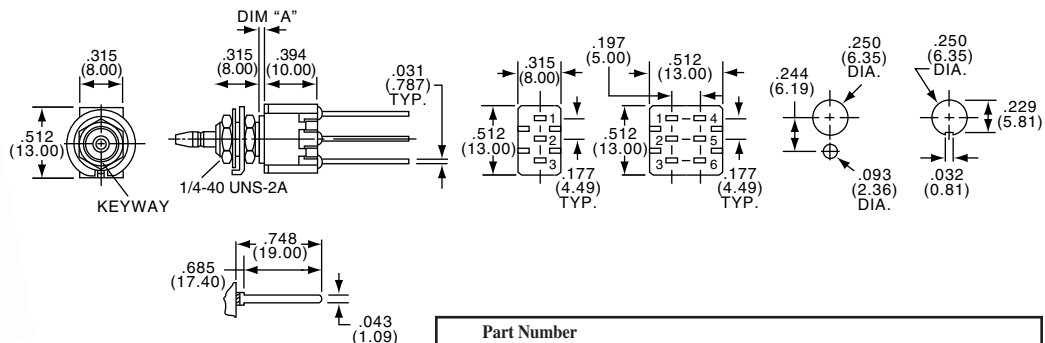

Part Number					
Tyco Electronics	Alcoswitch	Type	Action	Dim."A"	Terminals
6-1437567-7	MPS103FWW	SPDT	Momentary	.040(1.01)	Extended PC
-	MPS203NWW	DPDT	Push-on/Off	.100(2.54)	Extended PC
7-1437567-6	MPS203RWW	DPDT	Momentary	.040(1.01)	Extended PC

Caps not supplied, order separately. (See Cap Model C22 and C23 on Page D32.)

D
MPS Series

Pushbutton Switches, Snap Action, Right Angle, 3 Amp

SEE PAGE D25 FOR PRODUCT SPECIFICATIONS

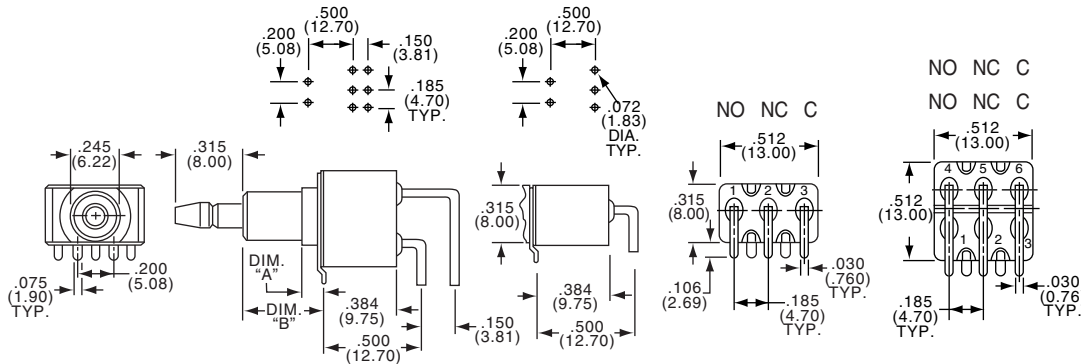

SPDT/DPDT



MPS103DRA



MPS203NRA

Part Number						
Tyco Electronics	Alcoswitch	Type	Action	Dim."A"	Dim."B"	Terminals
6-1437567-2	MPS103DRA	SPDT	Push-on/Off	.100(2.54)	.423(10.7)	Right Angle PC
6-1437567-6	MPS103FRA	SPDT	Momentary	.060(1.52)	.364(9.24)	Right Angle PC
7-1437567-1	MPS203NRA	DPDT	Push-on/Off	.100(2.54)	.423(10.7)	Right Angle PC
7-1437567-5	MPS203RRA	DPDT	Momentary	.060(1.52)	.364(9.24)	Right Angle PC

Caps not supplied, order separately.
(See Cap Model C22 and C23 on Page D32.)

MSP3/MSPS

Pushbutton Switches, 2.5mm Travel, Panel Mount

MATERIAL SPECIFICATIONS:

- ContactsSilver plate over copper alloy
- Case MaterialThermoplastic
- Actuator MaterialThermoplastic
- TerminalsSilver plate

ENVIRONMENTAL SPECIFICATIONS:

- Operating Temperature.....-4°F to +176°F (-20°C to +80°C)
- Storage Temperature.....+5°F to +153°F (-15°C to +75°C)
- Solder Heat ResistanceSee page M3-4
- Note: Hardware included with switches

TYPICAL PERFORMANCE CHARACTERISTICS:

- Contact RatingMSP103 - 3 Amps @ 125 VAC
(with over travel) .059" (1.5mm)
MSPS103 - 0.5 Amps @ 125 VAC
(Butt contact)
- Initial Contact Resistance100 Milliohms
- Contact TimingBreak-before-make
- Insulation Resistance1,000 Megohms min.
- Dielectric Strength1,000 Volts RMS @ sea level
- Life ExpectancyUp to 10,000 Cycles
- Travel2.5 mm

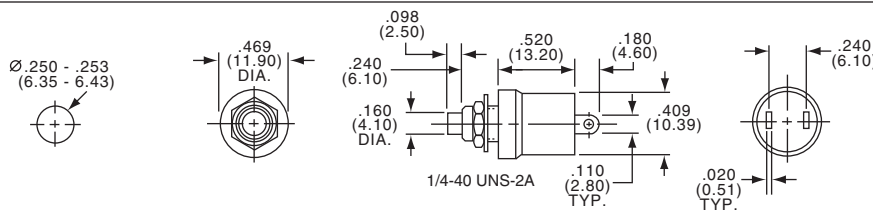

SPST



MSP103B

3 AMPS

Part Number						
Tyco Electronics	Alcoswitch	Type	Act. Code P. M6	Momentary Action	Bushing Length	Actuator Color
8-1437567-3	MSP103B	SPST	14	Normally Closed	.236	Black
8-1437567-4	MSP103C	SPST	13	Normally Open	.236	Red
8-1437567-5	MSP103C0	SPST	13	Normally Open	.236	Black
8-1437567-6	MSP103C2	SPST	13	Normally Open	.374	Red

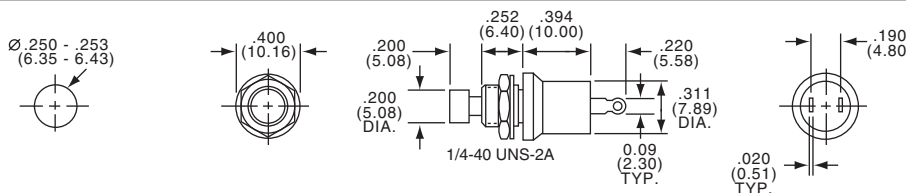

MSPS103B



0.5 AMPS

Part Number						
Tyco Electronics	Alcoswitch	Type	Act. Code P. M6	Momentary Action	Bushing Length	Actuator Color
1437568-5	MSPS103B	SPST	14	Normally Closed	.245	Black
1437568-6	MSPS103C2	SPST	13	Normally Open	.245	Red
1437568-7	MSPS103C0	SPST	13	Normally Open	.245	Black

Pushbutton Switches, Front or Rear Entry Mount, 15/32 Bushing

MATERIAL SPECIFICATIONS:

ContactsSilver plate
 Case MaterialThermoset
 Actuator MaterialThermoplastic
 TerminalsSilver plate
 Terminal SealEpoxy

TYPICAL PERFORMANCE CHARACTERISTICS:

Contact Rating0.5 A @ 125 VAC
 Initial Contact Resistance100 Milliohms
 Contact TimingBreak-before-make
 Insulation Resistance1,000 Megohms min.
 Dielectric Strength1,000 Volts RMS @ sea level
 Actuator Travel......098" (2.49)
 Life ExpectancyUp to 10,000 Cycles

ENVIRONMENTAL SPECIFICATIONS:

Operating Temperature.....-4°F to +176°F (-20°C to +80°C)
 Storage Temperature.....-4F to +176°F (-20°C to +80°C)

Application Note: Illustration shows versatile front or rear entry usage, with hardware supplied.

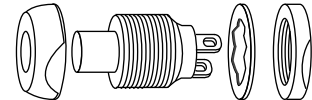

D

MSPF Series

SPST



MSPF101B

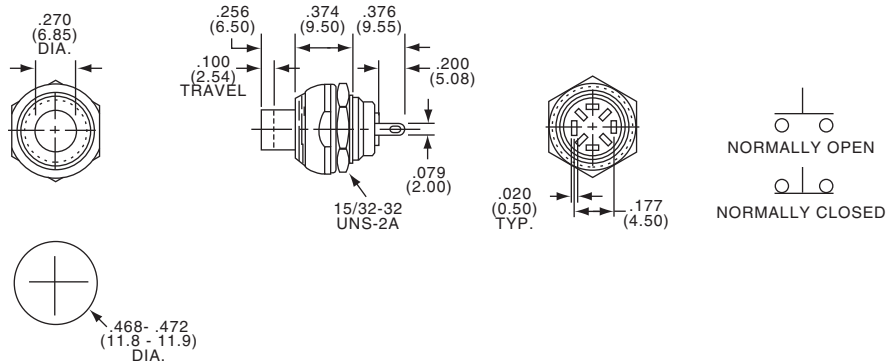

Part Number				
Tyco Electronics	Alcoswitch	Type	Action	Actuator Color
8-1437567-8	MSPF101B	SPST	Normally Closed	Black
9-1437567-3	MSPF101C	SPST	Normally Open	Red

2 CIRCUIT



MSPF101BC

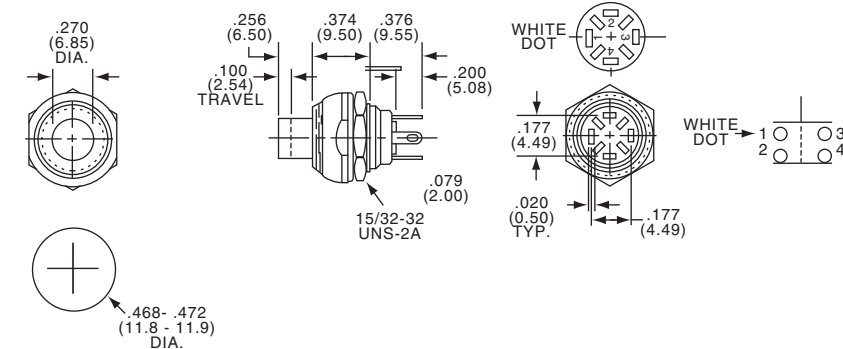

Part Number				
Tyco Electronics	Alcoswitch	Type	Action	Actuator Color
8-1437567-9	MSPF101BC0	2 Circuit	Normally open-normally closed	Black
9-1437567-0	MSPF101BC2	2 Circuit	Normally open-normally closed	Red
9-1437567-1	MSPF101BC6	2 Circuit	Normally open-normally closed	Blue
9-1437567-2	MSPF101BC9	2 Circuit	Normally open-normally closed	White