

TYPICAL INDICATOR ORDERING EXAMPLE

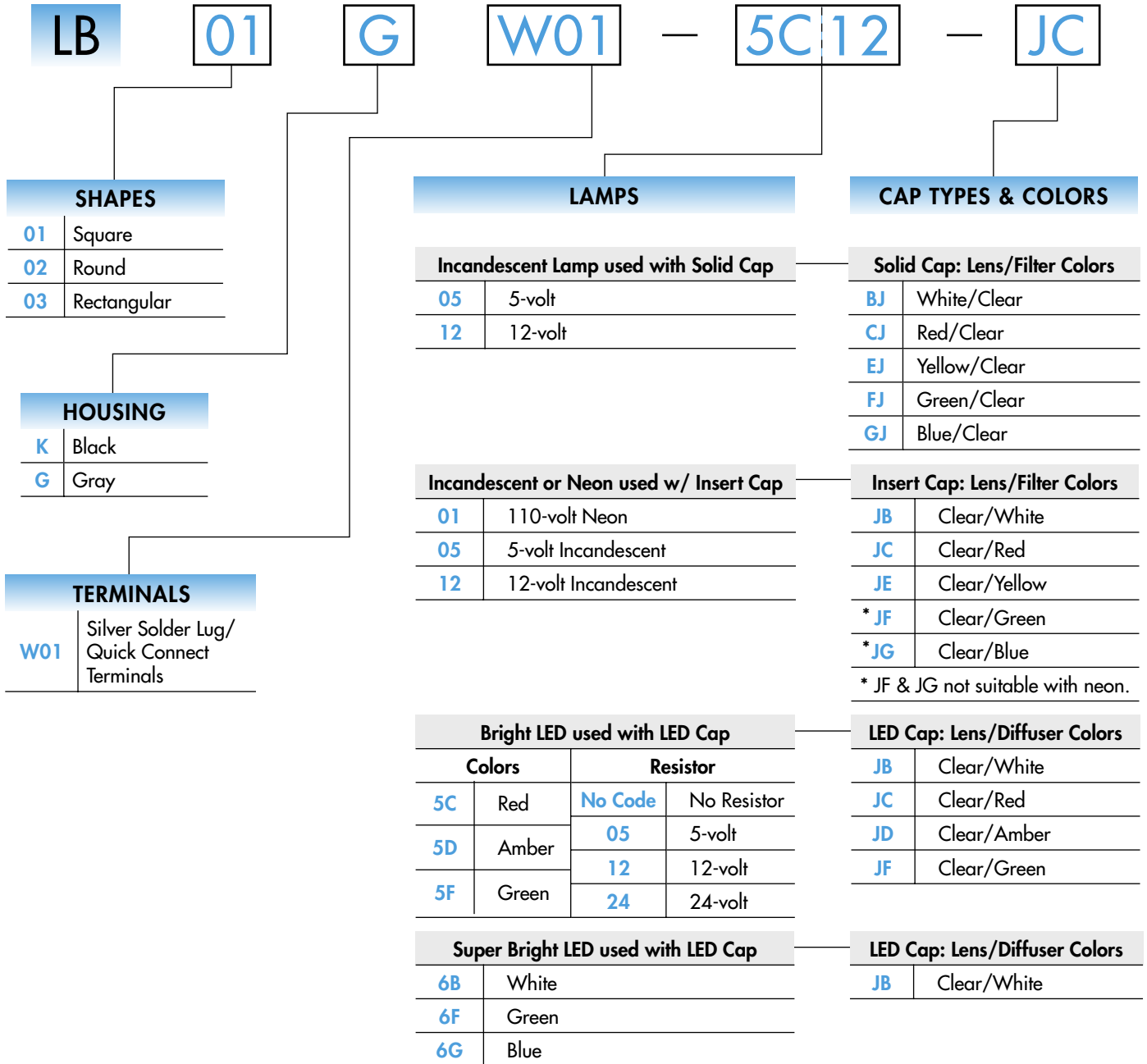

DESCRIPTION FOR TYPICAL ORDERING EXAMPLE

LB01GW01-5C12-JC

Clear Cap with Red Diffuser

Red, 12-volt,
Bright LED with Resistor

Square Shape and
Gray Housing

Silver Solder Lug/
Quick Connect
Terminals



SHAPES & PANEL CUTOUTS

01

**.622" (15.8mm)
Square**

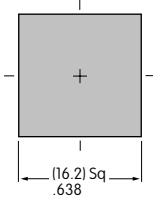
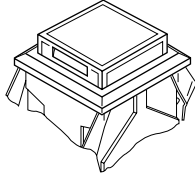

02

**.854" (21.7mm)
Round**

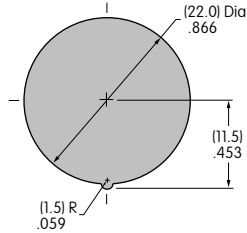

03

**.622" x .866" (15.8mm x 22.0mm)
Rectangular**

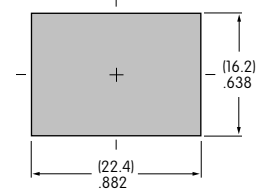
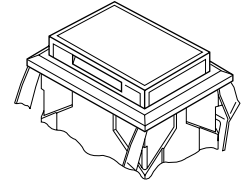

Panel Thickness: .039" ~ .157" (1.0 ~ 4.0mm)

HOUSING

Housing Colors Available:

K

Black

G

Gray

TERMINALS

W01

Silver Solder Lug/.110" (2.8mm) Quick Connect

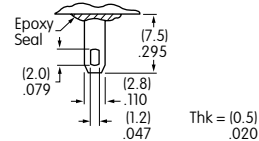

LAMP CODES & SPECIFICATIONS

Incandescent Lamp for Solid Colored and Colored Insert Caps

AT607  T-1 Bi-pin		05	12	
	Voltage	V	5V AC	12V AC
	Current	I	115mA	60mA
	Endurance	Hours	7,000 average	
	Ambient Temp. Range		-25°C ~ +50°C	



Neon Lamp for Colored Insert Cap

AT607N  T-1 Bi-pin		01	
	Voltage	V	110V AC
	Current	I	1.5mA
	Endurance	Hours	10,000 average
	Ambient Temp. Range		-25°C ~ +50°C
	Recommended Resistors: 33K ohms for 110V AC; 100K ohms for 220V AC		

The electrical specifications shown are determined at a basic temperature of 25°C.

LED COLORS & SPECIFICATIONS

The electrical specifications shown are determined at a basic temperature of 25°C. Polarity marks are on the device.
 If the source voltage exceeds the rated voltage, a ballast resistor is required.
 The resistor value can be calculated by using the formula in the Supplement section.
 Additional lamp detail is shown in the Accessories & Hardware section.

		Bright LED without Resistor					
		Red	Amber	Green	No Code No Resistor		
		5C	5D	5F	Red	Amber	Green
AT635 LEDs are colored in OFF state.   T-1 1/2 Bi-pin	Color Codes						
	Forward Peak Current	I_{FM}			30mA	30mA	30mA
	Continuous Forward Current	I_F			20mA	20mA	20mA
	Forward Voltage	V_F			1.9V	2.0V	2.1V
	Reverse Peak Voltage	V_{RM}			5V	5V	5V
	Current Reduction Rate Above 25°C	ΔI_F			0.42mA/°C	0.42mA/°C	0.42mA/°C
	Ambient Temperature Range	-25° ~ +50°C					

		Bright LED with Resistor					
		Red	Amber	Green	Resistor Codes		
		5C	5D	5F	05	12	24
AT627 with Resistor  T-1 Bi-pin	Color Codes:						
	Forward Peak Current	I_{FM}			—	—	—
	Continuous Forward Current	I_F			52mA	26mA	13mA
	Forward Voltage	V_F			5V	12V	24V
	Reverse Peak Voltage	V_{RM}			4V	8V	16V
	Current Reduction Rate Above 25°C	ΔI_F			0.50mA/°C		
	Ambient Temperature Range	-25° ~ +50°C					

AT627
5-volt
4-element
with Resistor

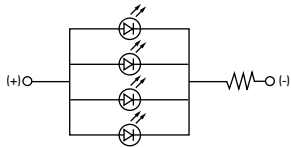

AT627
12-volt
4-element
with Resistor

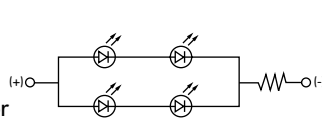

AT627
24-volt
4-element
with Resistor

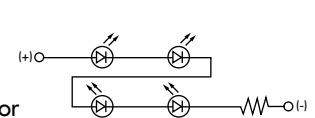

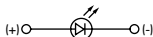
		Super Bright Single Element LED					
		Attention Electrostatic Sensitive Devices			6B	6F	6G
		Color			White	Green	Blue
AT625G Blue AT631B White AT632F Green   T-1 Bi-pin	Forward Peak Current	I_{FM}			30mA	30mA	30mA
	Continuous Forward Current	I_F			20mA	20mA	20mA
	Forward Voltage	V_F			3.6V	3.5V	3.6V
	Reverse Peak Voltage	V_{RM}			5V	5V	5V
	Current Reduction Rate Above 25°C	ΔI_F			0.50mA/°C		
	Ambient Temperature Range	-25° ~ +50°C					

CAP TYPES & COLOR COMBINATIONS

Color Codes: **B** White **C** Red **D** Amber **E** Yellow **F** Green **G** Blue **J** Clear

Solid Cap for Incandescent Lamp

Lens/Filter
Colors Available:

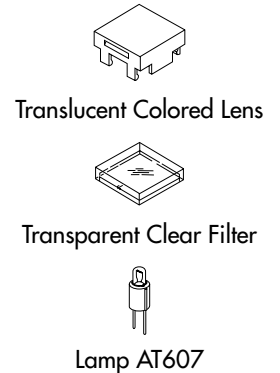
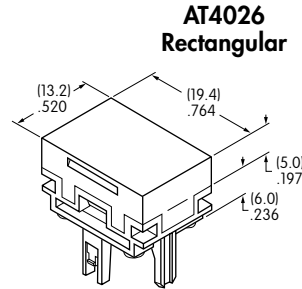
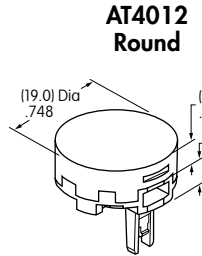
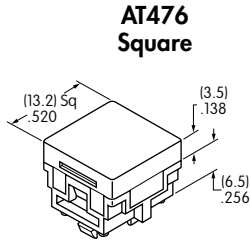
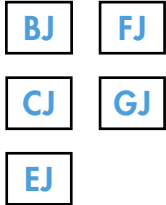

Material: Polycarbonate Finish: Glossy

Insert Cap for Incandescent or Neon Lamp

Lens/Filter
Colors Available:

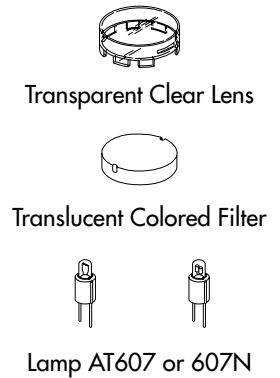
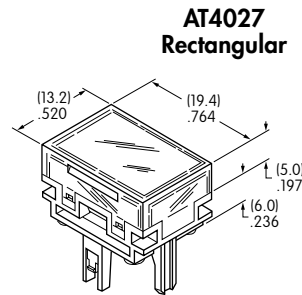
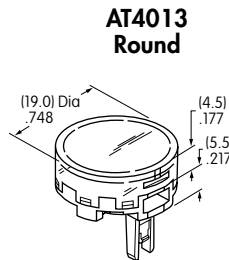
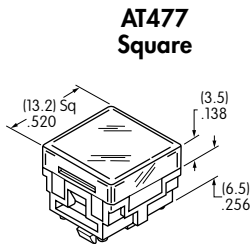
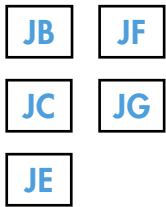

JF and JG not suitable with neon lamp.

Material: Polycarbonate Finish: Glossy

Cap for Bright LED without Resistor

Lens/Diffuser
Colors Available:

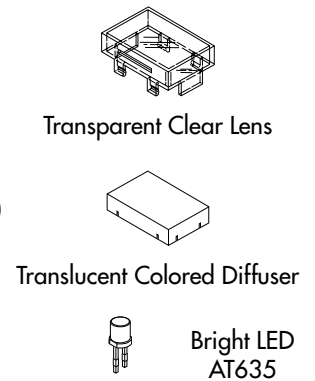
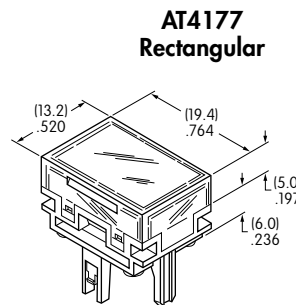
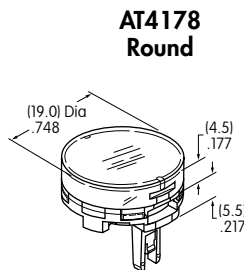
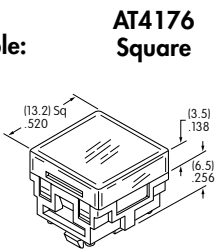

Material: Polycarbonate Finish: Glossy

Cap for Bright LED with Resistor

Lens/Diffuser
Colors Available:

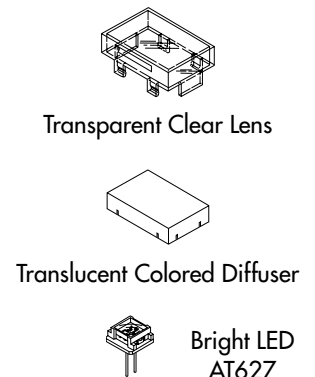
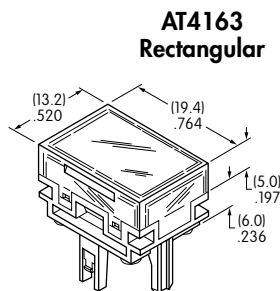
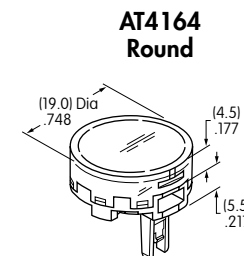
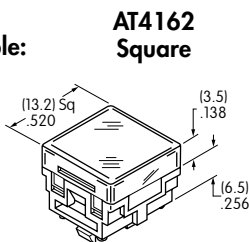

Material: Polycarbonate Finish: Glossy

CAP TYPES & COLOR COMBINATIONS

Cap for Super Bright LEDs

JB

Clear Lens
White Diffuser

AT4129
Square

AT4128
Round

AT4130
Rectangular

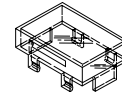

Transparent
Clear Lens

Material:
Polycarbonate
Finish: Glossy

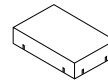
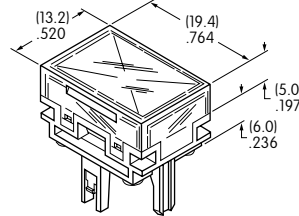
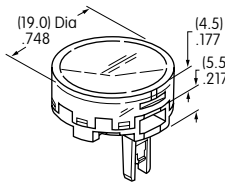
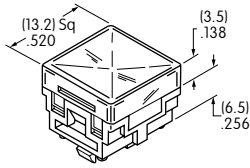

Translucent
White Diffuser



LEDs AT625
AT631 AT632

TYPICAL INDICATOR DIMENSIONS

Square

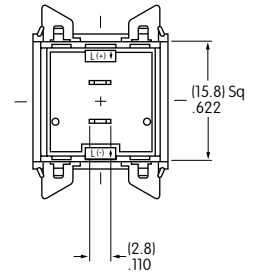
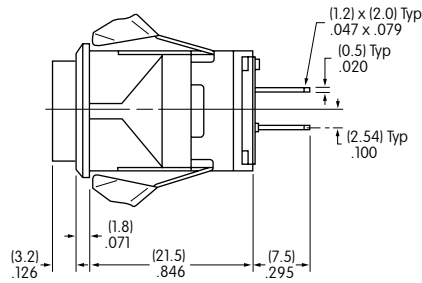
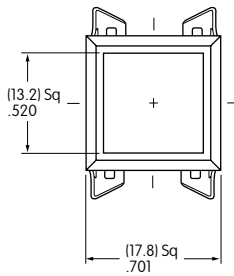

LB01KW01-12-CJ

Round

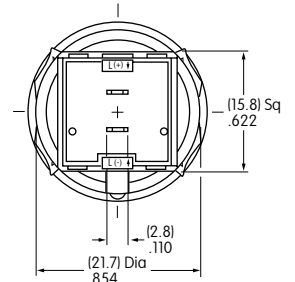
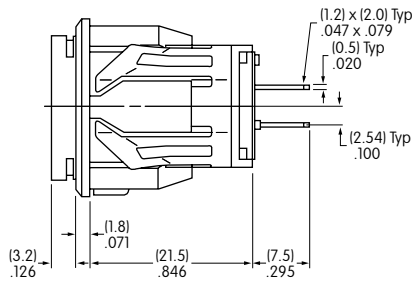
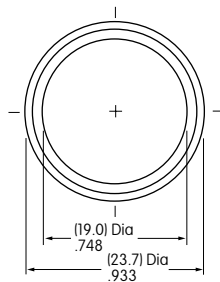

LB02KW01-12-CJ

Rectangular

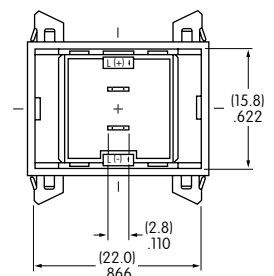
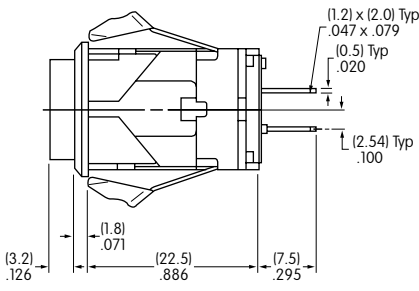
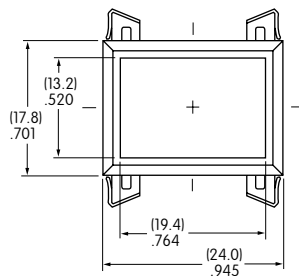

LB03KW01-12-CJ