

# Safety-door Switch D4BS

**The Special Operation Key Activates a Direct Opening Mechanism to Open the Contacts and Shut Off Control Circuits when Protective Doors Are Opened on Machine Tools or Other Equipment**

- Conforms to EN (TÜV) standards corresponding to the CE marking.
- Approved by UL, CSA, BIA, and SUVA standards.
- The Switch contact is opened by a direct opening mechanism (NC contacts only) when the protective cover is opened. The EN-approved direct opening mechanism is indicated by ⊕ on the Switch.
- Malfunctions and false operation prevented by special Operation Key.
- Wide temperature range specifications: -40 to 80°C.
- Degree of protection of the switch box: IP67 (EN60947-5-1).
- Series includes models with gold-plated contacts for handling the microload range.

**Note:** Be sure to read the "Precautions for All Safety Door Switches" on page A-2.



Safety Door  
Switches  
D4BS

## Model Number Structure

### Model Number Legend

#### Switch

D4BS -    S  
          1      2      3

#### 1. Conduit

- 1: PG13.5 (1 conduit)
- 2: G1/2 (1 conduit)
- 3: 1/2-14NPT (1 conduit)
- 5: PG13.5 (3-conduit)
- 6: G1/2 (3-conduit)
- 7: 1/2-14NPT (3-conduit)

#### 2. Built-in Switch

- 5: 1NC/1NO (slow-action)
- 6: 1NC/NO (slow-action), gold-plated contacts
- A: 2NC (slow-action)
- B: 2NC (slow-action), gold-plated contacts

#### 3. Head Mounting Direction

- F: Four mounting directions possible (front-side mounting at shipping)

#### Operation Key

D4BS - K   
                  1

#### 1. Operation Key Type

- 1: Horizontal mounting
- 2: Vertical mounting
- 3: Adjustable mounting (Horizontal)

**Note:** Do not order the head and Switch separately. (The Operation Key, however, must be ordered separately.)



## Ordering Information

### List of Models

**Switches (Operation Keys are sold separately.)**

Type	Mounting direction		Conduit size	1NC/1NO (Slow-action)	2NC (Slow-action)
1-conduit	Front-side mounting		Pg13.5	D4BS-15FS	D4BS-1AFS
			G1/2	D4BS-25FS	D4BS-2AFS
			1/2-14NPT	D4BS-35FS	D4BS-3AFS
3-conduit	Front-side mounting		Pg13.5	D4BS-55FS	D4BS-5AFS
			G1/2	D4BS-65FS	D4BS-6AFS
			1/2-14NPT	D4BS-75FS	D4BS-7AFS

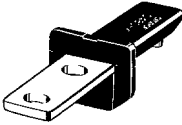
## Operation Keys (Order Separately)

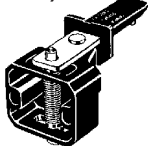
Type	Model
Horizontal mounting 	D4BS-K1
Vertical mounting 	D4BS-K2
Adjustable mounting (Horizontal) 	D4BS-K3

Safety Door Switches

D4BS

## Specifications

### Standards and EC Directives

- Conforms to the following EC Directives:
  - Machinery Directive
  - Low Voltage Directive
  - EN50041
  - EN1088

### Approved Standards

Agency	Standard	File No.
TÜV Rheinland	EN60947-5-1	R9351022 (Direct opening: approved) 
UL	UL508	E76675
CSA	CSA C22.2 No. 14	LR45746
BIA	GS-ET-15	9303323
SUVA	SUVA	E6187.d
CQC (CCC)	GB14048.5	2003010305073833

### Approved Standard Ratings

#### TÜV (EN60947-5-1), CCC (GB14048.5)

Utilization category	AC-15
Rated operating current ( $I_e$ )	2 A
Rated operating voltage ( $U_e$ )	400 V

Note: Use a 10-A fuse type a gI or gG that conforms to IEC60269 as a short-circuit protection device.

#### UL/CSA (UL508, CSA C22.2 No. 14)

#### A600

Rated voltage	Carry current	Current		Volt-amperes	
		Make	Break	Make	Break
120 VAC	10 A	60 A	6 A	7,200 VA	720 VA
240 VAC		30 A	3 A		
480 VAC		15 A	1.5 A		
600 VAC		12 A	1.2 A		

■ Characteristics

Degree of protection (see note 2)	IP67 (EN60947-5-1) (This applies for the Switch only. The degree of protection for the key hole is IP00.)
Durability (see note 3)	Mechanical: 1,000,000 operations min. Electrical: 500,000 operations min. (10 A at 250 VAC, resistive load)
Operating speed	0.1 m/s to 0.5 m/s
Operating frequency	30 operations/min max.
Rated frequency	50/60 Hz
Contact gap	2 x 2 mm min.
Direct opening force (see note 4)	19.61 N min. (EN60947-5-1)
Direct opening travel (see note 4)	20 mm min. (EN60947-5-1)
Full stroke	23 mm min.
Insulation resistance	100 MΩ min. (at 500 VDC) between terminals of same or different polarity, between each terminal and ground, and between each terminal and non-current-carrying metal part
Contact resistance	25 mΩ max. (initial value)
Rated insulation voltage (U <sub>i</sub> )	600 V (EN60947-5-1)
Conventional enclosed thermal current (I <sub>the</sub> )	20 A (EN60947-5-1)
Dielectric strength (U <sub>imp</sub> )	Impulse dielectric strength (U <sub>imp</sub> ) 4 kV (EN60947-5-1) between terminals of same or different polarity, between current-carrying metal parts and ground, and between each terminal and non-current-carrying metal part
Switching overvoltage	1,500 V max. (EN60947-5-1)
Conditional short-circuit current	100 A (EN60947-5-1)
Pollution degree (operating environment)	3 (EN60947-5-1)
Insulation class	Class I (with ground terminal)
Vibration resistance	Malfunction: 10 to 500 Hz, 0.65-mm single amplitude
Shock resistance	Destruction: 1,000 m/s <sup>2</sup> min. (IEC68-2-27) Malfunction: 300 m/s <sup>2</sup> min. (IEC68-2-27)
Ambient temperature	Operating: -40°C to 80°C (with no icing)
Ambient humidity	Operating: 95% max.
Weight	Approx. 285 g (in the case of D4BS-15FS)

Note: 1. The above values are initial values.

- The degree of protection is tested using the method specified by the standard (EN60947-5-1). Confirm that sealing properties are sufficient for the operating conditions and environment beforehand. Although the switch box is protected from dust, oil, or water penetration, do not use the D4BS in places where dust, oil, water, or chemicals may enter through the key hole on the head, otherwise Switch damage or malfunctioning may occur.
- The durability is for an ambient temperature of 5°C to 35°C and an ambient humidity of 40% to 70%. Contact your OMRON sales representative for more detailed information on other operating environments.
- These figures are minimum requirements for safe operation.

Connections

■ Contact Form (Diagrams Show State with Key Inserted)

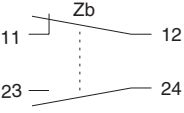
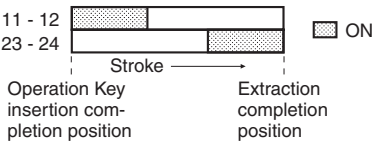
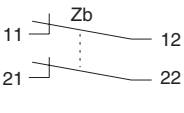
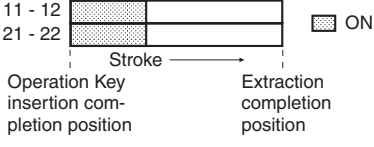
Model	Contact form	Operating pattern	Remarks
D4BS-□5□S	1NC/1NO 	11 - 12 23 - 24 	Only NC contact 11-12 has an approved direct opening mechanism. (→) Terminals 11-12 and 23-24 can be used as unlike poles.
D4BS-□A□S	2NC 	11 - 12 21 - 22 	NC contacts 11-12 and 21-22 have an approved direct opening mechanism. (→) Terminals 11-12 and 21-22 can be used as unlike poles.

Note: The terminal numbers are in accordance with EN50013, and the contact symbols are in accordance with IEC60947-5-1.

Safety Door Switches  
D4BS

# Nomenclature

Safety Door Switches  
D4BS

**Operation Key**

D4BS's exclusive-use Operation Key is provided to assure accurate switching operation.

**Set Zone Mark**

A triangular Set Zone Mark makes it easy to adjust the operating position when inserting the Operation Key.

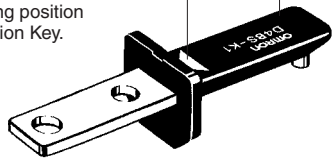

**Built-in Switch**

A shearing force contact separating mechanism (NC contact) is employed, which positively pulls apart the contacts from each other by using shearing force if any abnormality such as contact welding should occur in the contact area.

There is a difference in level between the NC and NO terminal, which assures easy wiring.

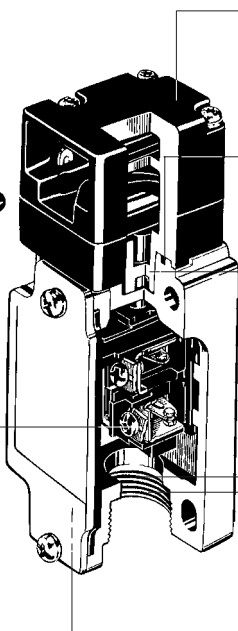

**Head**

The switch head is coated with easy-to-see red paint. The mounting direction of the switch head can be varied to any of the four directions.

**Seal Ring (NBR)**

**Oil Seal (NBR)**

The operation plunger employs an oil seal, with which the switch box meets the requirements of IP67 (the sealing capability of the Operation Key's insertion mouth is IP00).

**Seal Packing (NBR)**

**Conduit Opening**

**Ground Terminal Screw**

A ground terminal is provided to improve safety. (Built into the Unit.)

Box Size	1-conduit box	3-conduit box
Pg13.5	Yes	Yes
G1/2	Yes	Yes
1/2-14NPT	Yes	Yes

# Dimensions

## Switches

### 1-conduit

- D4BS-1□□S
- D4BS-2□□S
- D4BS-3□□S

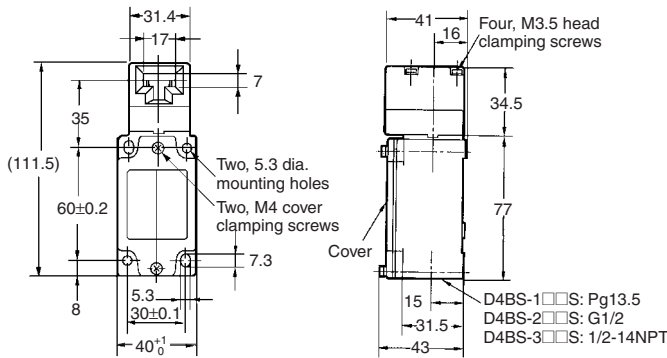
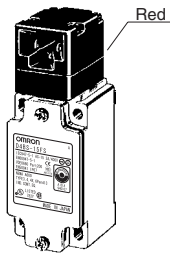

Operating characteristics	D4BS-1□□S D4BS-2□□S D4BS-3□□S
Key insertion force	19.61 N max.
Key extraction force	19.61 N max.
Pretravel (PT)	10±5 mm
Direct opening force	19.61 N min.
Direct opening stroke	20 mm min.

### 3-conduit

- D4BS-5□□S
- D4BS-6□□S
- D4BS-7□□S

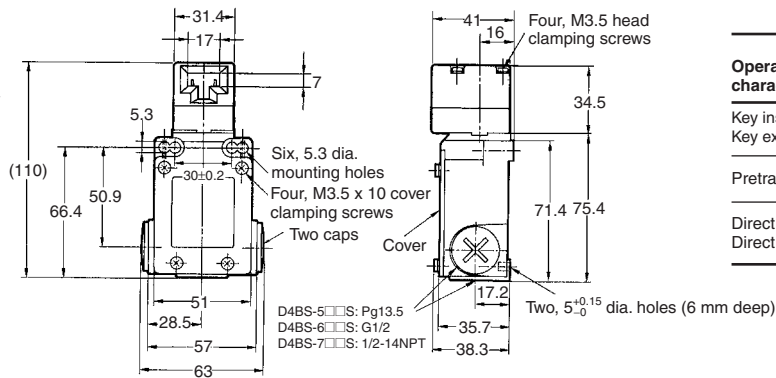
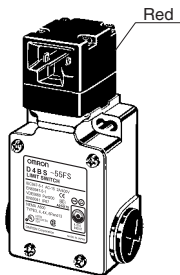

Operating characteristics	D4BS-5□□S D4BS-6□□S D4BS-7□□S
Key insertion force	19.61 N max.
Key extraction force	19.61 N max.
Pretravel (PT)	10±5 mm
Direct opening force	19.61 N min.
Direct opening stroke	20 mm min.

**Note:** 1. All units are in millimeters unless otherwise indicated.

2. Unless otherwise specified, a tolerance of ±0.4 mm applies to all dimensions.

3. There are fluctuations in the contact ON/OFF timing for 2NC contacts. Confirm performance before application.

4. The conduit thread varies with the model as follows:

Conduit thread	Model
Pg 13.5	D4BS-1□□S, D4BS-5□□S
G1/2	D4BS-2□□S, D4BS-6□□S
1/2-14NPT	D4BS-3□□S, D4BS-7□□S

## Operation Keys

### D4BS-K1

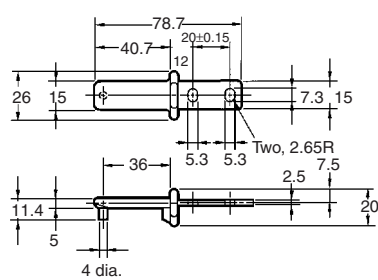
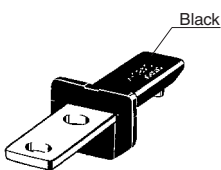

### D4BS-K2

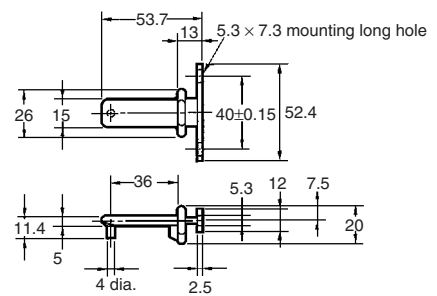
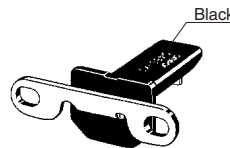

### D4BS-K3

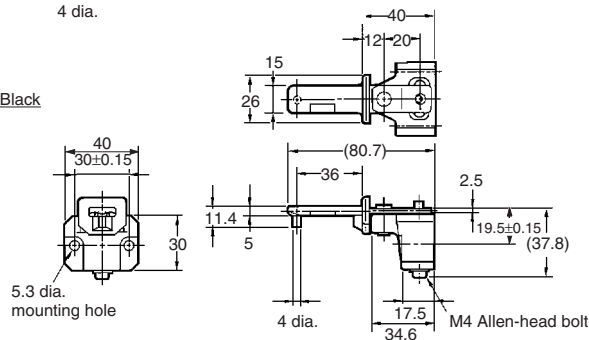
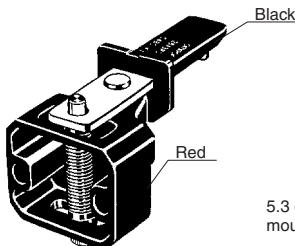

## With Operation Key Inserted

### Horizontal Mounting

- D4BS-1□□S + D4BS-K1
- D4BS-2□□S + D4BS-K1
- D4BS-3□□S + D4BS-K1

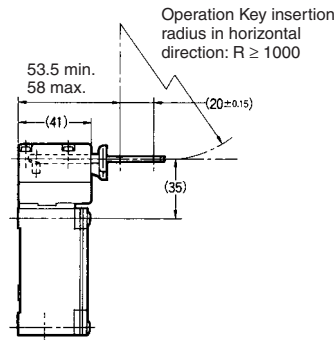
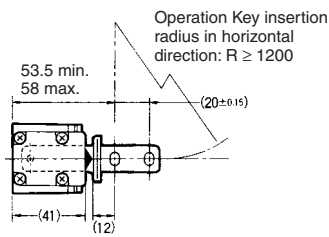
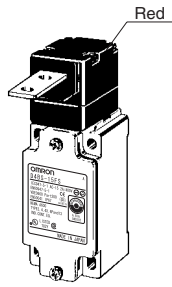

### Vertical Mounting

- D4BS-1□□S + D4BS-K2
- D4BS-2□□S + D4BS-K2
- D4BS-3□□S + D4BS-K2

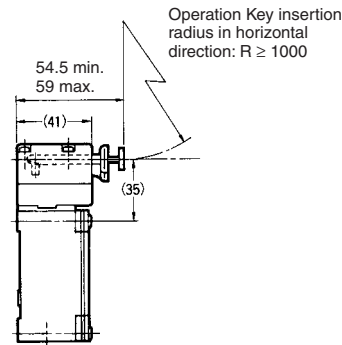
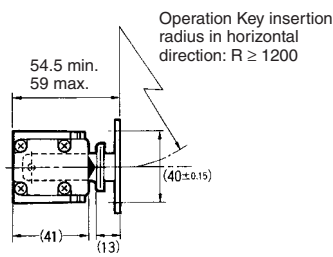
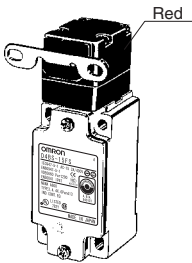

### Adjustable Mounting (Horizontal)

- D4BS-1□□S + D4BS-K3
- D4BS-2□□S + D4BS-K3
- D4BS-3□□S + D4BS-K3

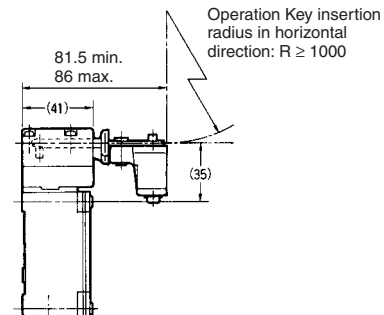
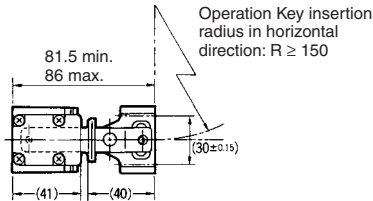
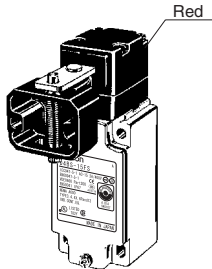

**Note:** "R" is the Operation Key insertion radius.

**Note:** Unless otherwise specified, a tolerance of  $\pm 0.4$  mm applies to all dimensions.

# Safety Precautions

Refer to the "Precautions for All Switches" on page I-2 and "Precautions for All Safety Door Switches" on page A-2.

## Precautions for Safe Use

- Do not use the Switch submersed in oil or water or in locations continuously subject to splashes of oil or water. Doing so may result in oil or water entering the Switch. (The IP67 degree of protection of the Switch specifies the amount of water penetration after the Switch is submersed in water for a certain period of time.)
- Although the Switch body is protected from the ingress of dust or water, avoid the ingress of foreign substance through the key hole on the head. Otherwise, accelerated wear or breaking may result.
- Always attach the cover after completing wiring and before using the Switch. Electric shock may occur if the Switch is used without the cover attached.

## Precautions for Correct Use

### Tightening Torque

Loose screws may result in malfunction. Tighten the screws to the specified torques.

Type	Torque
M3.5 terminal screw (including ground terminal screw)	0.59 to 0.78 N·m
Cover mounting screw (See note 1.)	1.18 to 1.37 N·m
Head mounting screw	0.78 to 0.98 N·m
M5 body mounting screw (See note 2.)	4.90 to 5.88 N·m
Operation Key mounting screw	2.35 to 2.75 N·m
Connector	1.77 to 2.16 N·m
Cap screw	1.27 to 1.67 N·m

- Note:** 1. Apply a torque of 0.78 to 0.88 N·m if the D4BS is a three-conduit model.  
 2. Apply a torque of 4.90 to 5.88 N·m for an Allen-head bolt. For a pan head screw, apply a torque of 2.35 to 2.75 N·m.

### Mounting Dimensions (M5)

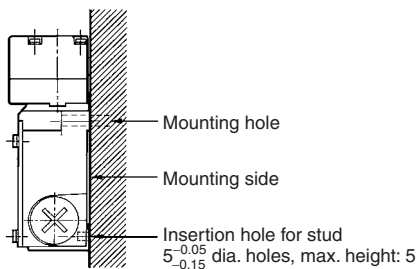
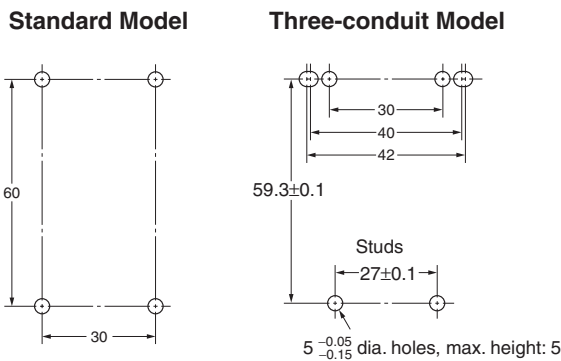

The D4BS can be mounted more securely by adding two studs, each of which is 5 mm maximum in height and  $5_{-0.05}^{-0.15}$  mm in diameter as shown below.

### Operation Key Mounting Dimensions

#### Horizontal Mounting

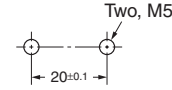

#### Vertical Mounting

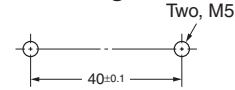

#### Adjustable Mounting (Horizontal)

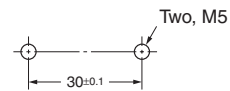

For safety, use screws that cannot be easily removed or a similar means to prevent the Switch and Operation Key from being easily removed.

### Operation Key

Make sure that the Operation Key can be inserted properly with a tolerance of  $\pm 0.5$  mm in the upward, downward, left, or right direction, otherwise the D4BS may soon become damaged.

Observe the specified insertion radius for the Operation Key and insert it in a direction perpendicular to the key hole.

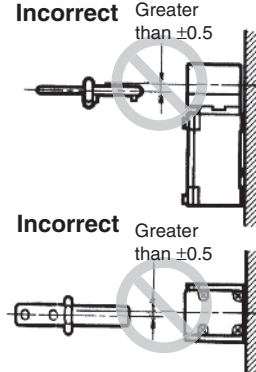

### Changes in Head Mounting Direction

By removing the screws on the four corners of the head, the head can be reset in any of four directions. The head direction can be changed with or without the Operation Key inserted in the head. Make sure that no foreign materials enter through the head and that the head is tightened securely within the proper torque range.

## Stopper Installation

Do not use a Switch as a stopper. Be sure to install a stopper as shown in the following illustration when mounting the Switch so that the base of the Operation Key does not strike the Head.

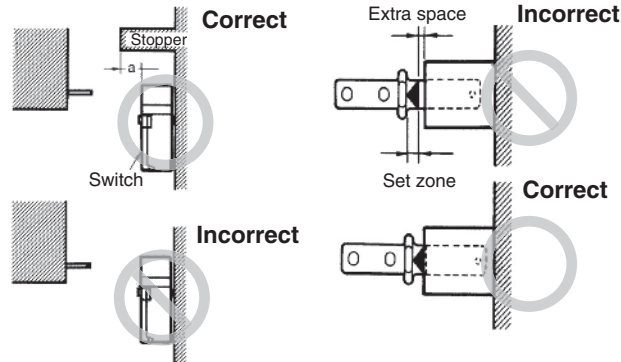

Refer to *Dimensions* for the mounting dimensions of the Operation Key and mount the Operation Key correctly. The Operation Key will soon become damaged or worn out if it is not mounted correctly.

## Wiring

Do not connect the lead wires directly to the terminals. Connect the lead wires through insulation tubes and M3.5 crimp terminals. Tighten each terminal screw within the proper torque range.

The proper lead wire is AWG20 to AWG14 (0.5 to 2.5 mm<sup>2</sup>) in size.

dz dia.:	3.7
D dia.:	4.5
B:	7.0
L:	20.2
F:	7.7
l:	9.0 (mm)

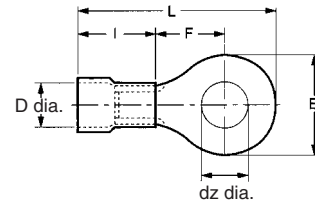

Wire using the methods shown below so that the crimp terminals are not caught on the case or cover. Otherwise it may not be possible to mount the cover completely and malfunctions may occur.

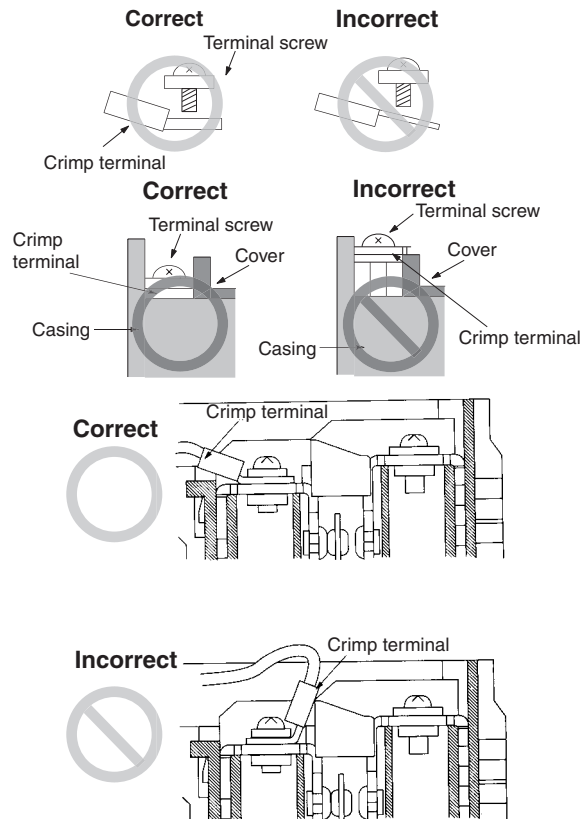

## Conduit Opening

Tighten the connector to a suitable torque. Excessive tightening torque may damage the casing.

When using 1/2-14NPT conduits, apply sealing tape between the connector and conduit opening to maintain the degree of protection (IP67) of the Switch. If using a Pg13.5 conduit, use an ABS-08 Pg13.5 connector or an ABS-12 Pg13.5 connector (manufactured by Nippon Flex).

Use a connector (SC Series, sold separately) suitable for the outer diameter of the cable.

When wiring a 3-conduit model, securely tighten the cap screw provided for unused conduit openings.

ALL DIMENSIONS SHOWN ARE IN MILLIMETERS.

To convert millimeters into inches, multiply by 0.03937. To convert grams into ounces, multiply by 0.03527.



# Terms and Conditions of Sale

1. **Offer; Acceptance.** These terms and conditions (these "Terms") are deemed part of all quotes, agreements, purchase orders, acknowledgments, price lists, catalogs, manuals, brochures and other documents, whether electronic or in writing, relating to the sale of products or services (collectively, the "Products") by Omron Electronics LLC and its subsidiary companies ("Omron"). Omron objects to any terms or conditions proposed in Buyer's purchase order or other documents which are inconsistent with, or in addition to, these Terms.
2. **Prices; Payment Terms.** All prices stated are current, subject to change without notice by Omron. Omron reserves the right to increase or decrease prices on any unshipped portions of outstanding orders. Payments for Products are due net 30 days unless otherwise stated in the invoice.
3. **Discounts.** Cash discounts, if any, will apply only on the net amount of invoices sent to Buyer after deducting transportation charges, taxes and duties, and will be allowed only if (i) the invoice is paid according to Omron's payment terms and (ii) Buyer has no past due amounts.
4. **Interest.** Omron, at its option, may charge Buyer 1-1/2% interest per month or the maximum legal rate, whichever is less, on any balance not paid within the stated terms.
5. **Orders.** Omron will accept no order less than \$200 net billing.
6. **Governmental Approvals.** Buyer shall be responsible for, and shall bear all costs involved in, obtaining any government approvals required for the importation or sale of the Products.
7. **Taxes.** All taxes, duties and other governmental charges (other than general real property and income taxes), including any interest or penalties thereon, imposed directly or indirectly on Omron or required to be collected directly or indirectly by Omron for the manufacture, production, sale, delivery, importation, consumption or use of the Products sold hereunder (including customs duties and sales, excise, use, turnover and license taxes) shall be charged to and remitted by Buyer to Omron.
8. **Financial.** If the financial position of Buyer at any time becomes unsatisfactory to Omron, Omron reserves the right to stop shipments or require satisfactory security or payment in advance. If Buyer fails to make payment or otherwise comply with these Terms or any related agreement, Omron may (without liability and in addition to other remedies) cancel any unshipped portion of Products sold hereunder and stop any Products in transit until Buyer pays all amounts, including amounts payable hereunder, whether or not then due, which are owing to it by Buyer. Buyer shall in any event remain liable for all unpaid accounts.
9. **Cancellation; Etc.** Orders are not subject to rescheduling or cancellation unless Buyer indemnifies Omron against all related costs or expenses.
10. **Force Majeure.** Omron shall not be liable for any delay or failure in delivery resulting from causes beyond its control, including earthquakes, fires, floods, strikes or other labor disputes, shortage of labor or materials, accidents to machinery, acts of sabotage, riots, delay in or lack of transportation or the requirements of any government authority.
11. **Shipping; Delivery.** Unless otherwise expressly agreed in writing by Omron:
  - a. Shipments shall be by a carrier selected by Omron; Omron will not drop ship except in "break down" situations.
  - b. Such carrier shall act as the agent of Buyer and delivery to such carrier shall constitute delivery to Buyer;
  - c. All sales and shipments of Products shall be FOB shipping point (unless otherwise stated in writing by Omron), at which point title and risk of loss shall pass from Omron to Buyer; provided that Omron shall retain a security interest in the Products until the full purchase price is paid;
  - d. Delivery and shipping dates are estimates only; and
  - e. Omron will package Products as it deems proper for protection against normal handling and extra charges apply to special conditions.
12. **Claims.** Any claim by Buyer against Omron for shortage or damage to the Products occurring before delivery to the carrier must be presented in writing to Omron within 30 days of receipt of shipment and include the original transportation bill signed by the carrier noting that the carrier received the Products from Omron in the condition claimed.
13. **Warranties.** (a) **Exclusive Warranty.** Omron's exclusive warranty is that the Products will be free from defects in materials and workmanship for a period of twelve months from the date of sale by Omron (or such other period expressed in writing by Omron). Omron disclaims all other warranties, express or implied. (b) **Limitations.** OMRON MAKES NO WARRANTY OR REPRESENTATION, EXPRESS OR IMPLIED, ABOUT NON-INFRINGEMENT, MERCHANTABILITY OR FITNESS FOR A PARTICULAR PURPOSE OF THE PRODUCTS. BUYER ACKNOWLEDGES THAT IT ALONE HAS DETERMINED THAT THE PRODUCTS WILL SUITABLY MEET THE REQUIREMENTS OF THEIR INTENDED USE. Omron further disclaims all warranties and responsibility of any type for claims or expenses based on infringement by the Products or otherwise of any intellectual property right. (c) **Buyer Remedy.** Omron's sole obligation hereunder shall be, at Omron's election, to (i) replace (in the form originally shipped with Buyer responsible for labor charges for removal or replacement thereof) the non-complying Product, (ii) repair the non-complying Product, or (iii) repay or credit Buyer an amount equal to the purchase price of the non-complying Product; provided that in no event shall Omron be responsible for warranty, repair, indemnity or any other claims or expenses regarding the Products unless Omron's analysis confirms that the Products were properly handled, stored, installed and maintained and not subject to contamination, abuse, misuse or inappropriate modification. Return of any Products by Buyer must be approved in writing by Omron before shipment. Omron Companies shall not be liable for the suitability or unsuitability or the results from the use of Products in combination with any electrical or electronic components, circuits, system assemblies or any other materials or substances or environments. Any advice, recommendations or information given orally or in writing, are not to be construed as an amendment or addition to the above warranty. See <http://oeweb.omron.com> or contact your Omron representative for published information.
14. **Limitation on Liability; Etc.** OMRON COMPANIES SHALL NOT BE LIABLE FOR SPECIAL, INDIRECT, INCIDENTAL, OR CONSEQUENTIAL DAMAGES, LOSS OF PROFITS OR PRODUCTION OR COMMERCIAL LOSS IN ANY WAY CONNECTED WITH THE PRODUCTS, WHETHER SUCH CLAIM IS BASED IN CONTRACT, WARRANTY, NEGLIGENCE OR STRICT LIABILITY. Further, in no event shall liability of Omron Companies exceed the individual price of the Product on which liability is asserted.
15. **Indemnities.** Buyer shall indemnify and hold harmless Omron Companies and their employees from and against all liabilities, losses, claims, costs and expenses (including attorney's fees and expenses) related to any claim, investigation, litigation or proceeding (whether or not Omron is a party) which arises or is alleged to arise from Buyer's acts or omissions under these Terms or in any way with respect to the Products. Without limiting the foregoing, Buyer (at its own expense) shall indemnify and hold harmless Omron and defend or settle any action brought against such Companies to the extent based on a claim that any Product made to Buyer specifications infringed intellectual property rights of another party.
16. **Property; Confidentiality.** Any intellectual property in the Products is the exclusive property of Omron Companies and Buyer shall not attempt to duplicate it in any way without the written permission of Omron. Notwithstanding any charges to Buyer for engineering or tooling, all engineering and tooling shall remain the exclusive property of Omron. All information and materials supplied by Omron to Buyer relating to the Products are confidential and proprietary, and Buyer shall limit distribution thereof to its trusted employees and strictly prevent disclosure to any third party.
17. **Export Controls.** Buyer shall comply with all applicable laws, regulations and licenses regarding (i) export of products or information; (ii) sale of products to "forbidden" or other proscribed persons; and (iii) disclosure to non-citizens of regulated technology or information.
18. **Miscellaneous.** (a) **Waiver.** No failure or delay by Omron in exercising any right and no course of dealing between Buyer and Omron shall operate as a waiver of rights by Omron. (b) **Assignment.** Buyer may not assign its rights hereunder without Omron's written consent. (c) **Law.** These Terms are governed by the law of the jurisdiction of the home office of the Omron company from which Buyer is purchasing the Products (without regard to conflict of law principles). (d) **Amendment.** These Terms constitute the entire agreement between Buyer and Omron relating to the Products, and no provision may be changed or waived unless in writing signed by the parties. (e) **Severability.** If any provision hereof is rendered ineffective or invalid, such provision shall not invalidate any other provision. (f) **Setoff.** Buyer shall have no right to set off any amounts against the amount owing in respect of this invoice. (g) **Definitions.** As used herein, "including" means "including without limitation"; and "Omron Companies" (or similar words) mean Omron Corporation and any direct or indirect subsidiary or affiliate thereof.

## Certain Precautions on Specifications and Use

1. **Suitability of Use.** Omron Companies shall not be responsible for conformity with any standards, codes or regulations which apply to the combination of the Product in the Buyer's application or use of the Product. At Buyer's request, Omron will provide applicable third party certification documents identifying ratings and limitations of use which apply to the Product. This information by itself is not sufficient for a complete determination of the suitability of the Product in combination with the end product, machine, system, or other application or use. Buyer shall be solely responsible for determining appropriateness of the particular Product with respect to Buyer's application, product or system. Buyer shall take application responsibility in all cases but the following is a non-exhaustive list of applications for which particular attention must be given: (i) Outdoor use, uses involving potential chemical contamination or electrical interference, or conditions or uses not described in this document. (ii) Use in consumer products or any use in significant quantities. (iii) Energy control systems, combustion systems, railroad systems, aviation systems, medical equipment, amusement machines, vehicles, safety equipment, and installations subject to separate industry or government regulations. (iv) Systems, machines and equipment that could present a risk to life or property. Please know and observe all prohibitions of use applicable to this Product.  
NEVER USE THE PRODUCT FOR AN APPLICATION INVOLVING SERIOUS RISK TO LIFE OR PROPERTY OR IN LARGE QUANTITIES WITHOUT ENSURING THAT THE SYSTEM AS A WHOLE HAS BEEN DESIGNED TO ADDRESS THE RISKS, AND THAT THE OMRON'S PRODUCT IS PROPERLY RATED AND INSTALLED FOR THE INTENDED USE WITHIN THE OVERALL EQUIPMENT OR SYSTEM.
2. **Programmable Products.** Omron Companies shall not be responsible for the user's programming of a programmable Product, or any consequence thereof.
3. **Performance Data.** Data presented in Omron Company websites, catalogs and other materials is provided as a guide for the user in determining suitability and does not constitute a warranty. It may represent the result of Omron's test conditions, and the user must correlate it to actual application requirements. Actual performance is subject to the Omron's Warranty and Limitations of Liability.
4. **Change in Specifications.** Product specifications and accessories may be changed at any time based on improvements and other reasons. It is our practice to change part numbers when published ratings or features are changed, or when significant construction changes are made. However, some specifications of the Product may be changed without any notice. When in doubt, special part numbers may be assigned to fix or establish key specifications for your application. Please consult with your Omron's representative at any time to confirm actual specifications of purchased Product.
5. **Errors and Omissions.** Information presented by Omron Companies has been checked and is believed to be accurate; however, no responsibility is assumed for clerical, typographical or proofreading errors or omissions.

Complete "Terms and Conditions of Sale" for product purchase and use are on Omron's website at [www.omron.com/oei](http://www.omron.com/oei) – under the "About Us" tab, in the Legal Matters section.

**ALL DIMENSIONS SHOWN ARE IN MILLIMETERS.**

To convert millimeters into inches, multiply by 0.03937. To convert grams into ounces, multiply by 0.03527.



**OMRON ELECTRONICS LLC**

One Commerce Drive  
Schaumburg, IL 60173

**847-843-7900**

For US technical support or other inquiries:

**800-556-6766**

**OMRON CANADA, INC.**

885 Milner Avenue  
Toronto, Ontario M1B 5V8

**416-286-6465**

**OMRON ON-LINE**

Global - <http://www.omron.com>  
USA - <http://www.omron.com/oei>  
Canada - <http://www.omron.ca>