

POS. 1 DESIGNATE  
PIN #1 LOCATION

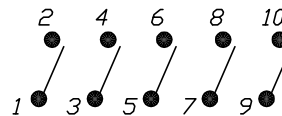

CONTACT CONFIGURATION

\* (Pos. 1 Denotes Pin No. 1)

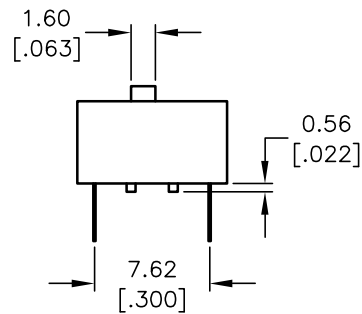
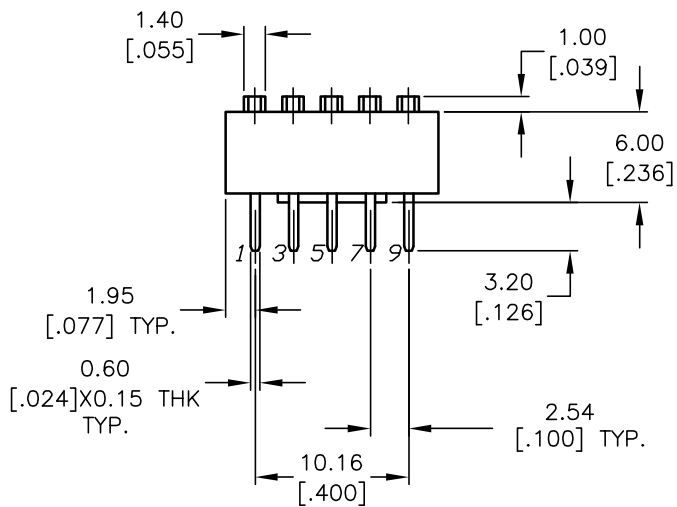
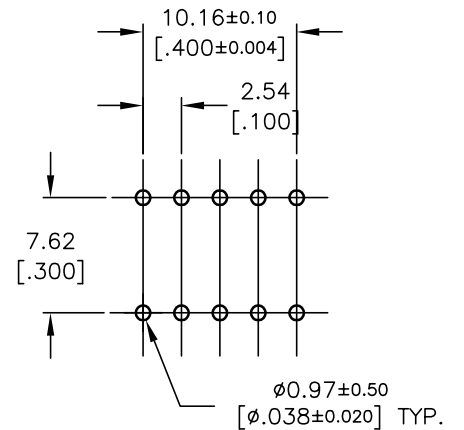

RECOMMEND P.C.B. LAYOUT

NOTES:

1. ALL DIMENSIONS IN MM [INCH]
2. GENERAL TOLERANCE: X.X=±0.4  
X.XX=±0.25
3. TERM. NOS. FOR REFERENCE ONLY.
- ▲ 4. SWITCHES SUPPLIED IN DISPENSING TUBES  
WITH ALL POLES IN THE "OFF" POSITION.
5. ▲ DENOTES CRITICAL PARAMETER.

**E-SWITCH®**

TITLE				
KAS1105E				
SCALE	DATE	DR	DWG	REV
2:1	9/15/03	AR	N211050	A

A	13446	RELEASED FOR PRODUCTION	9/15/03	AR
REV.	ECN No.	DESCRIPTION	DATE	CHKD

THE INFORMATION CONTAINED IN THIS DOCUMENT  
IS PROPRIETARY TO E-SWITCH AND IS  
NOT TO BE COPIED OR TRANSFERRED