

POS. 1 DESIGNATE
PIN #1 LOCATION

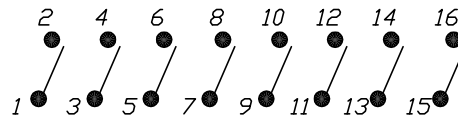

CONTACT CONFIGURATION

*(Pos. 1 Denotes Pin No. 1)

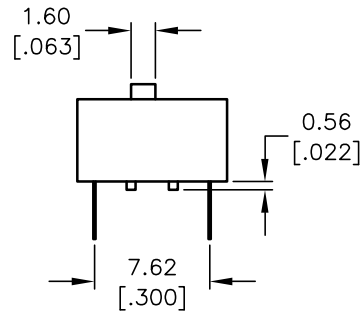
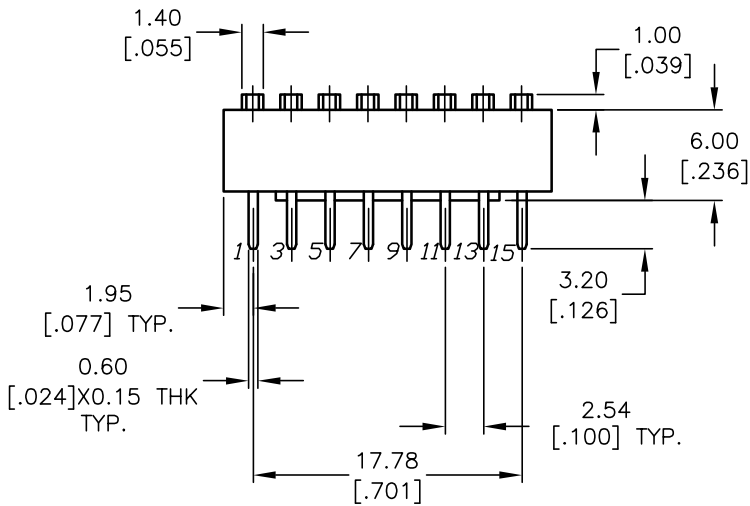
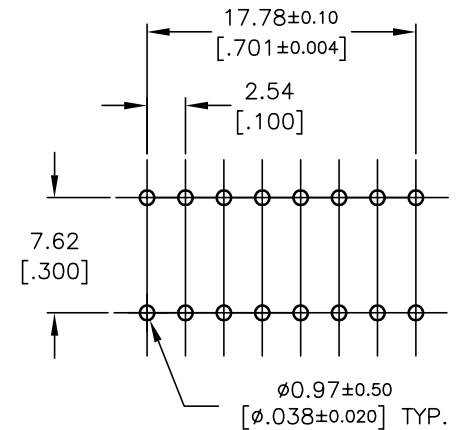

RECOMMEND P.C.B. LAYOUT

NOTES:

1. ALL DIMENSIONS IN MM [INCH]
2. GENERAL TOLERANCE: X.X=±0.4
X.XX=±0.25
3. TERM. NOS. FOR REFERENCE ONLY.
- ▲ 4. TOP TAPE SEAL FOR FLUX WASH.
- ▲ 5. SWITCHES SUPPLIED IN DISPENSING TUBES
WITH ALL POLES IN THE "OFF" POSITION.
6. ▲ DENOTES CRITICAL PARAMETER.

E-SWITCH®

TITLE					KAS1108ET									
SCALE	2:1		DATE	9/15/03		DR	AR		DWG	N211081		REV	A	

THE INFORMATION CONTAINED IN THIS DOCUMENT
IS PROPRIETARY TO E-SWITCH AND IS
NOT TO BE COPIED OR TRANSFERRED