

NOTES:

1. ALL DIMENSIONS IN MM [INCH]
2. GENERAL TOLERANCE: X.X=±0.4  
X.XX=±0.25
3. TERM. NOS. FOR REF. ONLY
4. CONTACT RATING: 4A @125VAC/28VDC, 2A @250VAC
5. DIELECTRIC STRENGTH: 1KV RMS min. at sea level
6. ELECTRICAL LIFE: 10,000 make-and-break cycles at full load.
7. MATERIALS:

CONTACTS: Silver Plated CU (Q Contact material)  
 TERMINALS: GOLD Plated Cu (Q Contact material)  
 MOUNTING NUT: Nickel Plated zinc alloy  
 CONTACT SPRING: Piano Wire  
 KEYS (2): Brass with code no. 604  
 LOCK: Bright Ni plated zinc alloy with Ni facing  
 TUMBLER Mechanism: 4-disc tumbler cylinder.

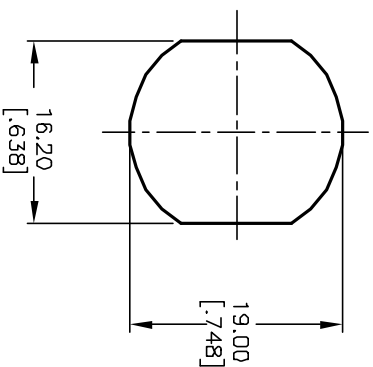

RECOMMENDED PANEL LAYOUT

CIRCUIT: DP (90° INDEXING) CONTACT CONFIGURATION	
SWITCH FUNCTION	CONNECTED TERMINAL #
POS. 1	POS. 2
8-1, 4-5	1-3, 5-7

LEGEND

- =Detent Positions (45° or 90°)
- ⊙ =Key pull possible in these positions

REV.	ECN NO.	DESCRIPTION	DATE	CHK'D
A	11714	RELEASED FOR PRODUCTION	10/5/01	CJB

TITLE	SCALE	DATE	DR	DWG	REV
K0130Q-604	1.5:1	10/5/01	CJB	K200267	A

**E-SWITCH®**

THE INFORMATION CONTAINED IN THIS DOCUMENT IS PROPRIETARY TO E-SWITCH AND IS NOT TO BE COPIED OR TRANSMITTED.