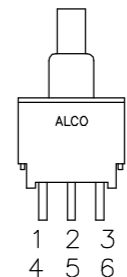
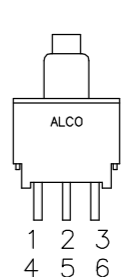
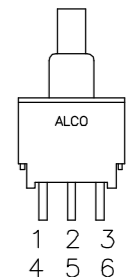
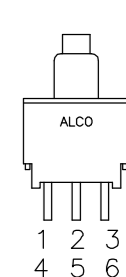

THIS DRAWING IS UNPUBLISHED. RELEASED FOR PUBLICATION
 © COPYRIGHT BY TYCO ELECTRONICS CORPORATION. ALL RIGHTS RESERVED.

LOC		DIST		REVISIONS			
P	LTR	DESCRIPTION	DATE	DWN	APVD		
	A	RELEASED	-	-	-		

SPECIFICATIONS	
CURRENT RATING MAX	50mA @ 48 VDC or peak AC (2.4VA)
CURRENT RATING MIN	1µA @ 20VDC or peak AC (.02VA)
TERMINATION RESISTANCE	50 milliohms max at 1.5mA 200µVAC
INSULATION RESISTANCE	1000 megohms min @ 500 VDC
DIELECTRIC WITHSTANDING VOLTAGE	500 V RMS at sea level
OPERATING TEMPERATURE	-20°C to +85°C
STORAGE TEMPERATURE	-40°C to +85°C
PLUNGER TRAVEL	.047±.010
ELECTRICAL LIFE	
50mA @ 48 VDC or peak AC	10,000 cycles
1µA @ 20VDC or peak AC	20,000 cycles
.4VA max @ 20 VDC or peak AC	30,000 cycles

MATERIALS		
COMPONENT NAME	BASE MATERIAL	FINISH
HOUSING	PBT, UL94 V-0, GRAY	
FRAME	BRASS	TIN
BUTTON	PBT, UL94 V-0, BLACK	
MOVEABLE CONTACT	PHOSPHOR BRONZE	GOLD OVER NICKEL
TERMINAL (CONTACT AREA)	PHOSPHOR BRONZE	GOLD OVER NICKEL
TERMINAL (SOLDER AREA)	PHOSPHOR BRONZE	GOLD OVER NICKEL

TYCO PART NUMBER	ALCO PART NUMBER	POLES	THROWS	TERMINAL	ACTUATOR LENGTH	FUNCTION		CONNECTED TERMINALS	
									
1825181-1	APBE1FGRA04	1	2	RA	.157	ON	(ON)	2-3	2-1
1825181-2	APBE2RGRA04	2	2	RA	.157	ON	(ON)	2-3,5-6	1-2,4-5

1. TERMINAL NUMBERS ARE FOR REFERENCE ONLY AND DO NOT APPEAR ON SWITCHES
2. ALL MATERIALS AND FINISHES SHALL COMPLY WITH EU DIRECTIVE 2003/95/EC OF 27JAN2003 (ROHS)
3. SWITCHES ARE SEALED AND ABLE TO WITHSTAND SOLDER WASH OPERATION.

THIS DRAWING IS A CONTROLLED DOCUMENT.

DWN	M.BINNER	28OCT2005
CHK	M.ZITTO	28OCT05
APVD	M.ZITTO	28OCT05
PRODUCT SPEC	-	
APPLICATION SPEC	-	
WEIGHT	-	
CUSTOMER DRAWING	-	

tyco Electronics Tyco Electronics Corporation
Harrisburg, PA 17105-3608

NAME: SWITCH, PUSHBUTTON APBE SERIES

SIZE	CAGE CODE	DRAWING NO	RESTRICTED TO
A2	00779	C=1825181	-

SCALE: 4:1 SHEET: 1 of 2 REV: A

1825181

THIS DRAWING IS UNPUBLISHED. RELEASED FOR PUBLICATION
 © COPYRIGHT BY TYCO ELECTRONICS CORPORATION. ALL RIGHTS RESERVED.

Loc		DIST		REVISIONS			
P	LTR	DESCRIPTION	DATE	DWN	APVD		
-	-	SEE SHEET 1	-	-	-		

APBE1FGRA

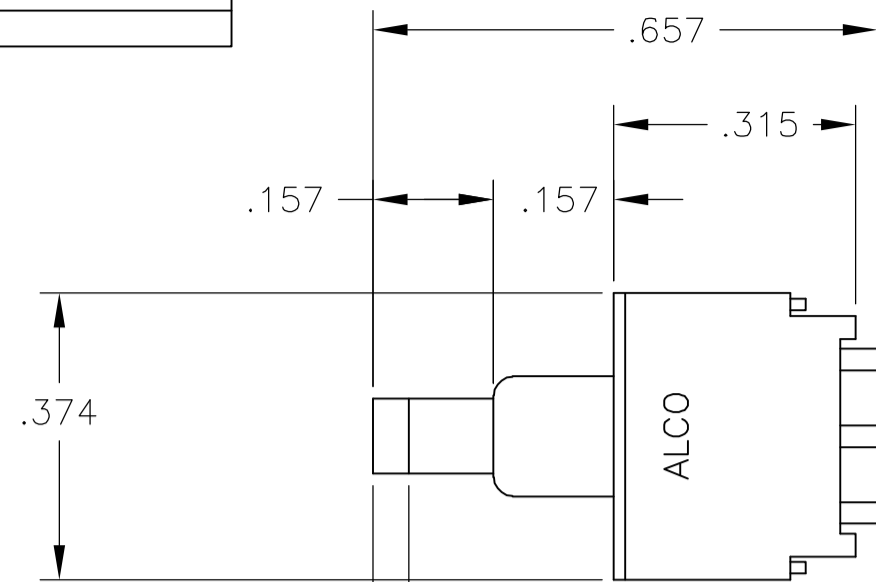
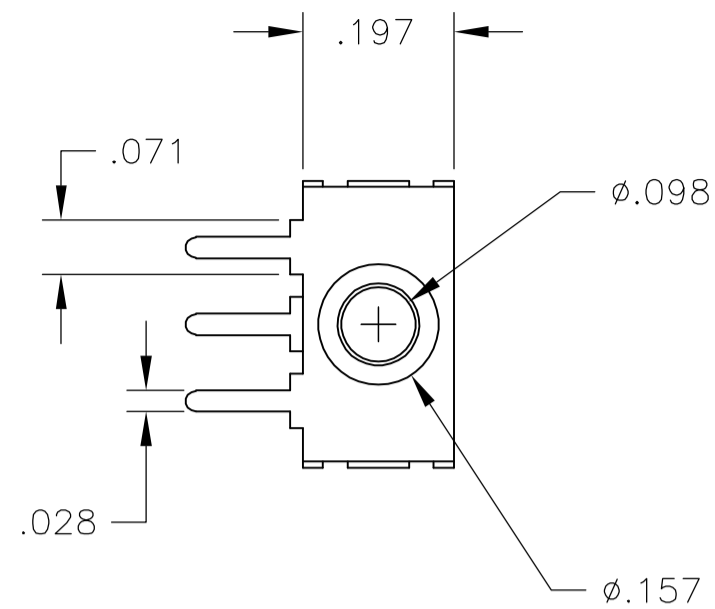

.047 STROKE

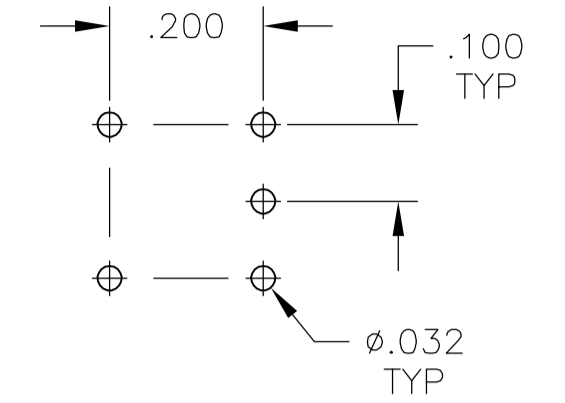
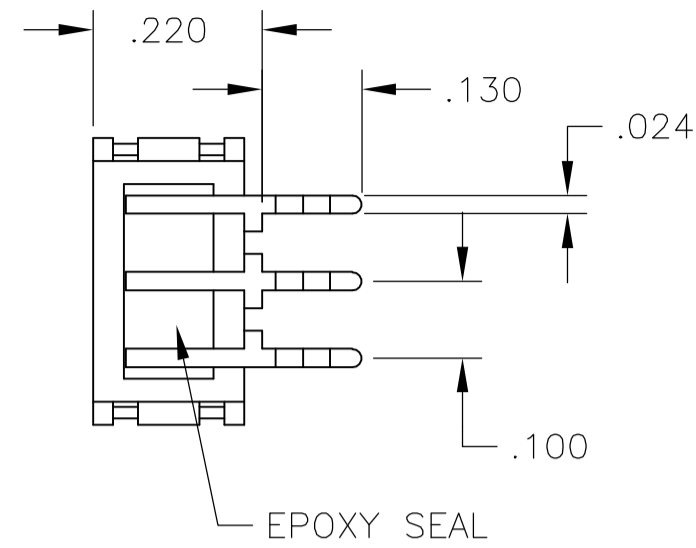
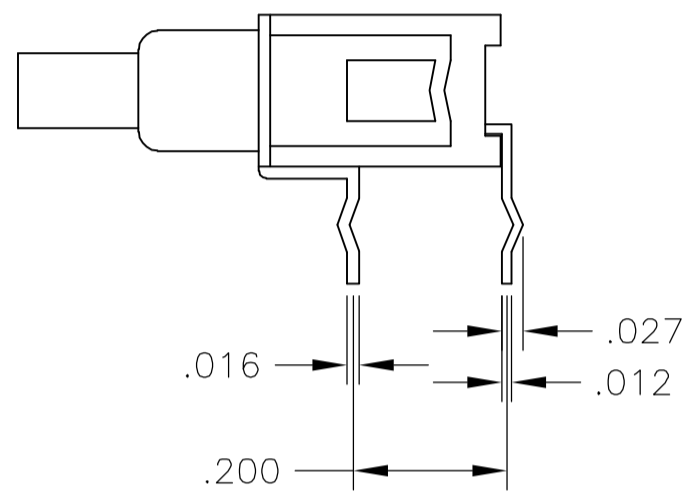

P.C. HOLE LAYOUT

APBE2FGRA

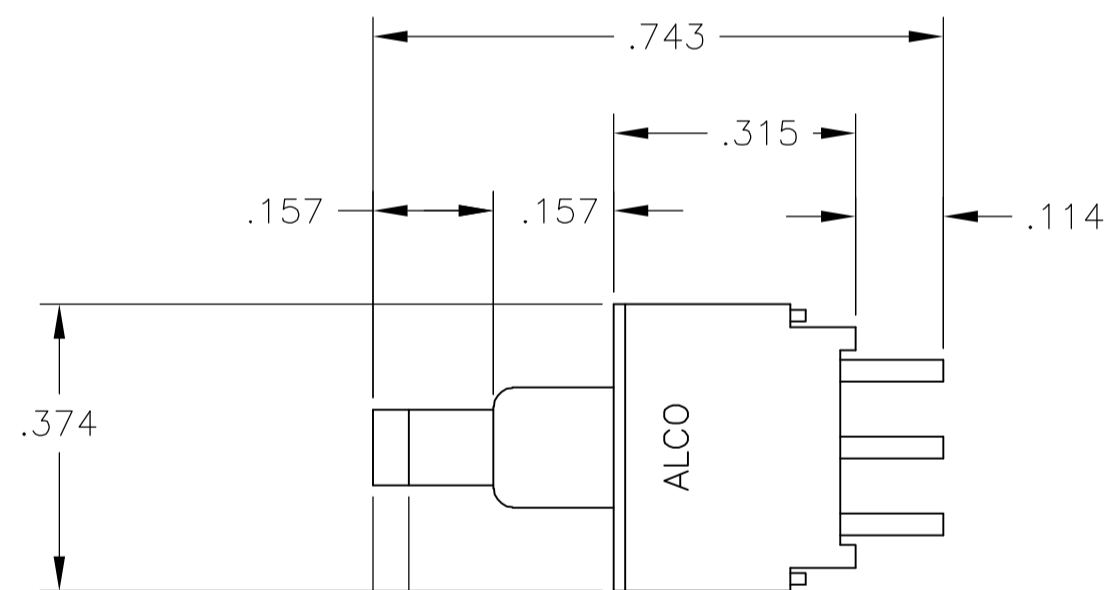
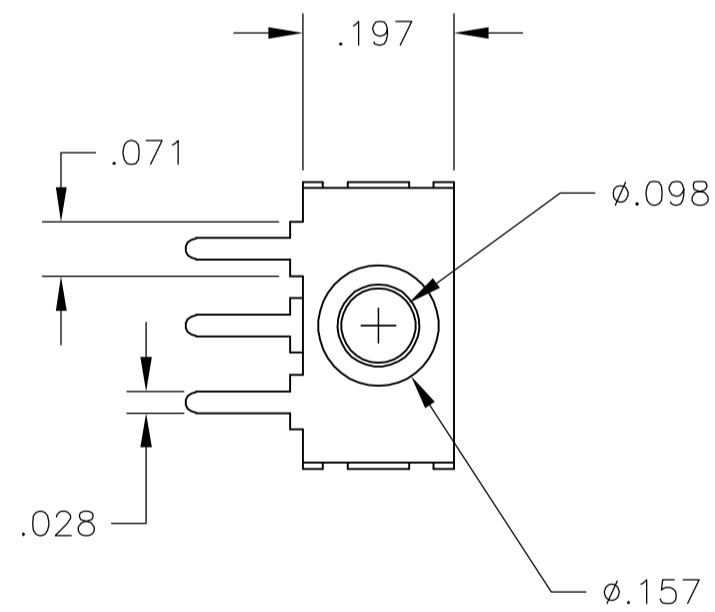

.047 STROKE

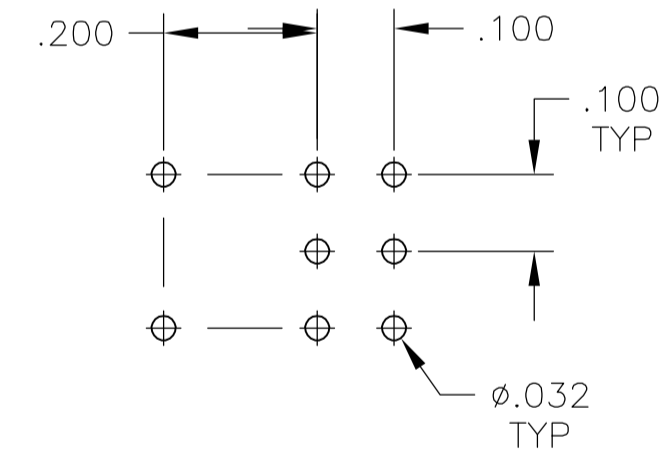
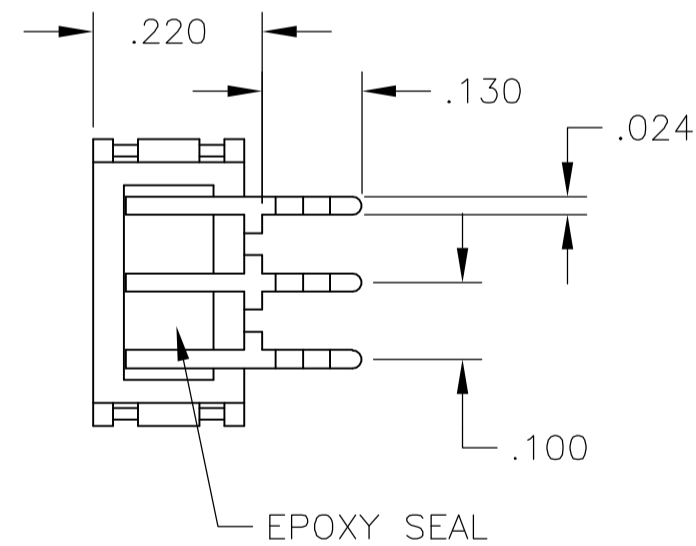
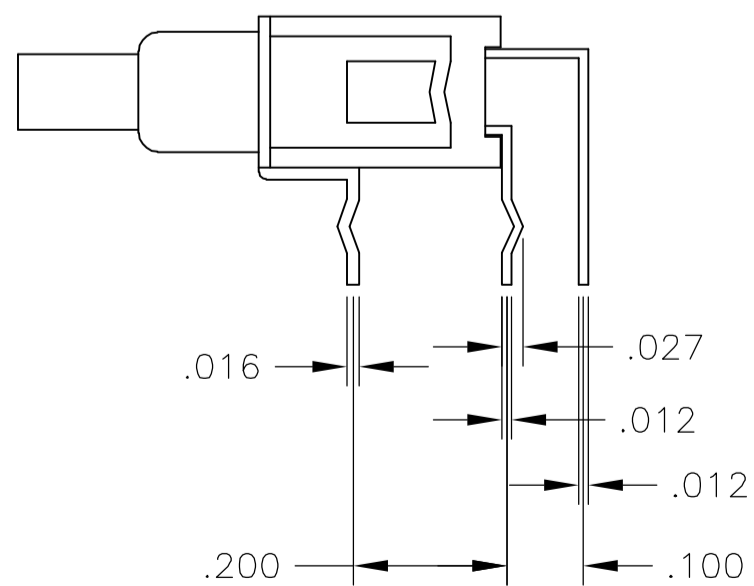

P.C. HOLE LAYOUT

THIS DRAWING IS A CONTROLLED DOCUMENT.		DWN M.BINNER 28OCT2005	Tyco Electronics Corporation Harrisburg, PA 17105-3608		
DIMENSIONS: INCHES		CHK M.ZITTO 28OCT05			
TOLERANCES UNLESS OTHERWISE SPECIFIED:		APVD M.ZITTO 28OCT05	NAME SWITCH, PUSHBUTTON APBE SERIES		
0 PLC ± - 1 PLC ± - 2 PLC ± - 3 PLC ± .005 4 PLC ± - ANGLES ± -		PRODUCT SPEC	RESTRICTED TO		
MATERIAL		APPLICATION SPEC	SIZE A2	CAGE CODE 00779	DRAWING NO 1825181
FINISH		WEIGHT	SCALE 4:1		
		CUSTOMER DRAWING	SHEET 2 of 2		
			REV A		