

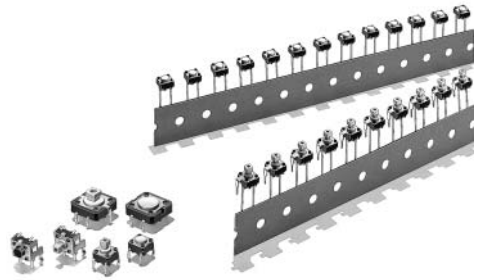

A Wide Range of Models: 6 x 6 mm, 12 x 12 mm, Vertical, and High-force.

- ROHS compliant.
- A positive click action plus a long life equal to that of a no-contact switch.
- Radial models (taping specifications) that allow the use of general-purpose radial taping parts insertion machines have been added to the series.





Ordering Information

6 x 6 mm Models

Type	Plunger	Height	Operating force (of)	Bags (100 Switches)	
				Without ground terminal	With ground terminal
Horizontal (B3F-1000)	Flat 	4.3 mm	0.98 N {100 gf}	B3F-1000	B3F-1100
			1.47 N {150 gf}	B3F-1002	B3F-1102
			2.55 N {260 gf}	B3F-1005	B3F-1105
			4.9 N {50 gf}	B3F-1006 (See note.)	–
		5.0 mm	0.98 N {100 gf}	B3F-1020	B3F-1120
			1.47 N {150 gf}	B3F-1022	B3F-1122
			2.55 N {260 gf}	B3F-1025	B3F-1125
			4.9 N {50 gf}	B3F-1026 (See note.)	–
		5.0 mm (7.5-mm pitch)	0.98 N {100 gf}	–	B3F-1110
		7.0 mm	0.98 N {100 gf}	B3F-1060 (See note.)	–
	1.47 N {150 gf}		B3F-1062 (See note.)	–	
	9.5 mm	0.98 N {100 gf}	B3F-1070 (See note.)	–	
		1.47 N {150 gf}	B3F-1072-N (See note.)	–	
		2.55 N {260 gf}	B3F-1075 (See note.)	–	
Projected 	7.3 mm	0.98 N {100 gf}	B3F-1050	B3F-1150	
		1.47 N {150 gf}	B3F-1052	B3F-1152	
		2.55 N {260 gf}	B3F-1055	B3F-1155	
		4.9 N {50 gf}	B3F-1056 (See note.)	–	

6 x 6 mm Models

Type	Plunger	Height	Operating force (of)	Bags (100 Switches)		
				Without ground terminal	With ground terminal	
Vertical (B3F-3000)		3.15 mm	0.98 N {100 gf}	–	B3F-3100	
			1.47 N {150 gf}	–	B3F-3102	
			2.55 N {260 gf}	–	B3F-3105	
		3.85 mm	0.98 N {100 gf}	–	B3F-3120	
			1.47 N {150 gf}	–	B3F-3122	
			2.55 N {260 gf}	–	B3F-3125	
	Projected		6.15 mm	0.98 N {100 gf}	–	B3F-3150
				1.47 N {150 gf}	–	B3F-3152
				2.55 N {260 gf}	–	B3F-3155

Note: Switches are sold in units of 100 Switches. Orders must be made in multiples of 100 (the quantity per bag).

12 x 12 mm Models

Type	Plunger or LED colour	Height	Operating force	Bags (100 Switches)	
				Without ground terminal	With ground terminal
Standard (B3F-4000)	Flat	4.3 mm	1.27 N {130 gf}	B3F-4000	B3F-4100
			2.55 N {260 gf}	B3F-4005	B3F-4105
	Projected	7.3 mm	1.27 N {130 gf}	B3F-4050	B3F-4150
			2.55 N {260 gf}	B3F-4055	B3F-4155
Long life expectancy (B3F-5000)	Flat	4.3 mm	1.27 N {130 gf}	B3F-5000	B3F-5100
	Projected	7.3 mm		B3F-5050	B3F-5150
High reliability gold-plated (B3F-5000)	Flat	4.3 mm	1.27 N {130 gf}	B3F-5001	B3F-5101
	Projected	7.3 mm		B3F-5051	B3F-5151

Note: Switches are sold in units of 100 Switches. Orders must be made in multiples of 100 (the quantity per bag).

6 x 6 mm Radial Models (Taping Specifications)

Type	Plunger	Height	Operating force 0.98 N {100 gf}		Operating force 1.47 N {150 gf}	
			Without ground terminal	With ground terminal	Without ground terminal	With ground terminal
Standard (B3F-6000)	Flat	4.3 mm	B3F-6000	B3F-6100	B3F-6002	B3F-6106
		5.0 mm	B3F-6020	B3F-6120	B3F-6022	B3F-6122
	Projected	7.3 mm	B3F-6050	B3F-6150	B3F-6052	B3F-6152

Note: Switches are sold in units of 1,000 Switches. Orders must be made in multiples of 1,000. Switches are not sold individually.

■ Accessories (Order Separately)

Special Key Tops are available for projected plunger models.

Specifications

■ Rating/Characteristics

Switching capacity	1 to 50 mA, 5 to 24 VDC (resistive load)
Ambient temperature	-25°C to 70°C (with no icing)
Ambient humidity	35% to 85%
Contact form	SPST-NO
Contact resistance	100 mΩ max. (initial value) (rated: 1 mA, 5 VDC)
Insulation resistance	100 MΩ min. (at 250 VDC)
Dielectric strength	500 VAC, 50/60 Hz for 1 min
Bounce time	5 ms max.
Vibration resistance	Malfunction: 10 to 55 Hz, 1.5 mm double amplitude
Shock resistance	Destruction: 1,000 m/s ² (approx. 100G) max. Malfunction: 100 m/s ² (approx. 10G) max.
Life expectancy	B3F-1000, B3F-3000, B3F-6000: 1,000,000 operations min (OF: 0.98 N) (B3F-1070: 500,000 operations min) 300,000 operations min (OF: 1.47 N) 100,000 operations min (OF: 2.55 N) 50,000 operations min (OF: 4.9 N) B3F-4000: 3,000,000 operations min (OF: 1.28 N) 1,000,000 operations min (OF: 2.55 N) B3F-5000: 10,000,000 operations min.
Weight	6 x 6 mm models: approx. 0.25 g 12 x 12 mm models (standard types): approx. 0.85 g Radial models: approx. 0.25 g

■ Operating Characteristics

Operating force (OF)	B3F-1000, B3F-3000, B3F-6000				B3F-4000, B3F-5000	
	0.98 N	1.47 N	2.55 N	4.9 N	1.27 N	2.55 N
	B3F-1 □□ B3F-3 □□ B3F-6 □□	B3F-1 □□ B3F-3 □□ B3F-6 □□	B3F-1 □□ B3F-3 □□	B3F-10 □	B3F-4 □□ B3F-5 □□	B3F-4 □□
Operating force (OF)	0.98±0.29 N {100±30 gf}	1.47±0.49 N {150±50 gf}	2.55±0.69 N {260±70 gf}	4.9±1.47N {100±30 gf}	1.27±0.49 N {130±50 gf}	2.55±0.69 N {260±70 gf}
Relapsing force (RF)	0.2 N {20 gf} min.	0.49 N {50 gf} min.	0.49 N {50 gf} min.	0.7 N {70 gf} min.	0.29 N {30 gf} min.	0.49 N min. {50 gf}
Pretravel (PT)	0.25 ^{+0.2} / _{-0.1} mm				0.3 ^{+0.2} / _{-0.1} mm	

Engineering Data

Operating Force vs. Stroke (Typical)
B3F-1000, -3000, -6000

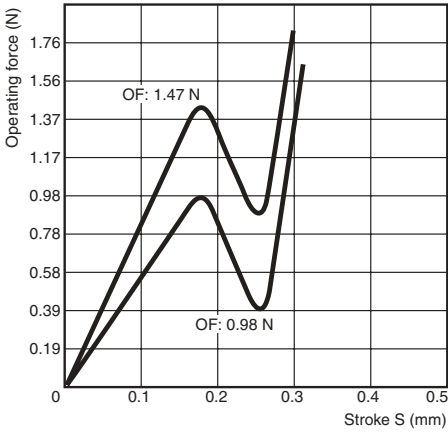

B3F-4000, -5000

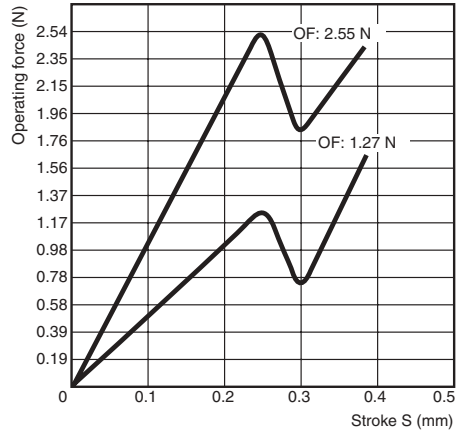

Dimensions

Note 1. All units are in millimeters unless otherwise indicated. Unless otherwise specified, a tolerance of ± 0.4 mm applies to all dimensions.

2. No terminal numbers are indicated on the Switches. The numbers used for terminals in the following graphics are indicated in the "Bottom View" diagram below. In this diagram, the Switch is rotated so that the terminals are on the right and left-hand sides, and the OMRON logo appears the right way up.



6 x 6 mm Models

Horizontal, Flat Plunger Type (without Ground Terminal)

B3F-1000, B3F-1002, B3F-1005, B3F-1006
B3F-1020 (See note.), B3F-1022 (See note.),
B3F-1025 (See note.), B3F-1026 (See note.)

Horizontal, Flat Plunger Type (with Ground Terminal, Pitch: 6.5 mm)

B3F-1100, B3F-1102, B3F-1105
B3F-1120 (See note.), B3F-1122 (See note.),
B3F-1125 (See note.)

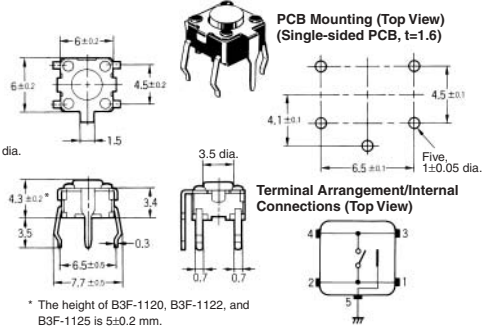
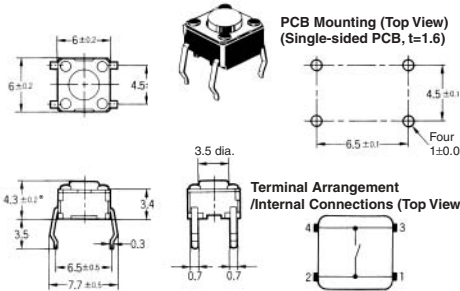

Horizontal, Flat Plunger Type (with Ground Terminal, Pitch: 7.5 mm)

B3F-1110

Horizontal, Flat Plunger Type (without Ground Terminal)

B3F-1060, B3F-1062

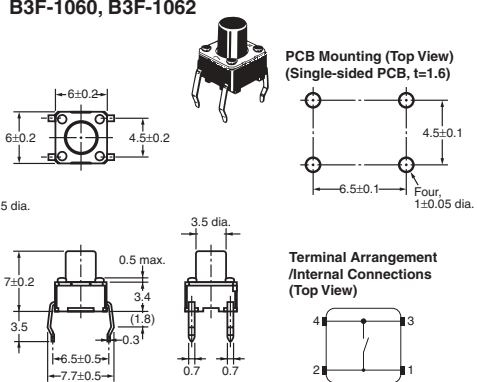
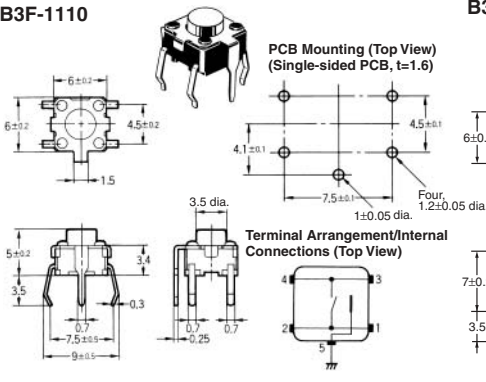

**Horizontal, Flat Plunger Type
(without Ground Terminal)**
B3F-1070, B3F-1072-N, B3F-1075

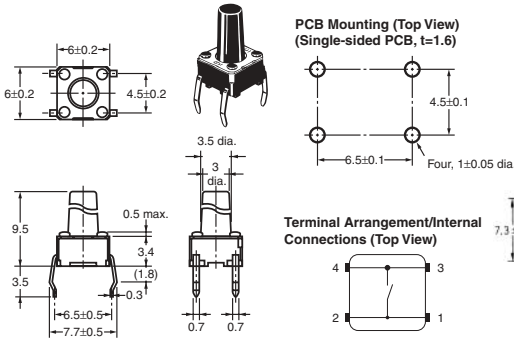

**Horizontal, Projected Plunger Type
(without Ground Terminal)**
B3F-1050, B3F-1052
B3F-1055, B3F-1056

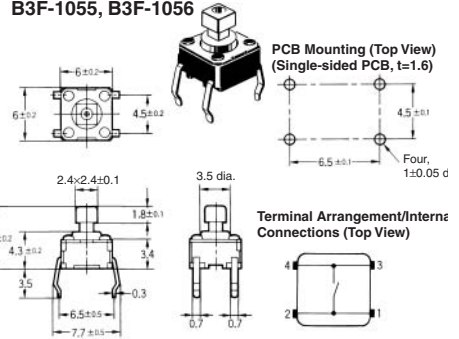

**Horizontal, Projected Plunger Type
(with Ground Terminal)**
B3F-1150, B3F-1152, B3F-1155

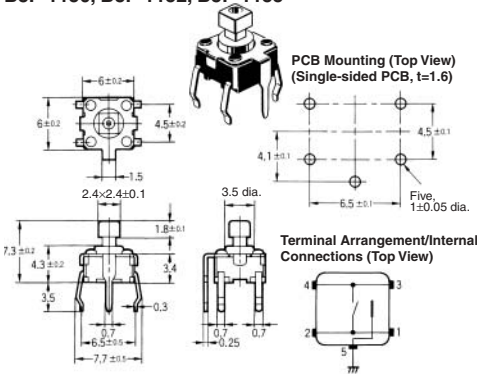

Vertical, Flat Plunger Type
B3F-3100, B3F-3102, B3F-3105

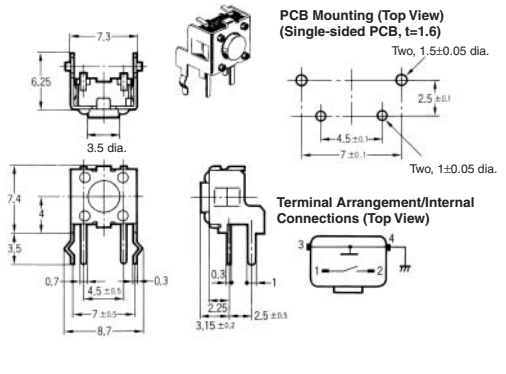

Vertical, Flat Plunger Type (Height: 3.85 mm)
B3F-3120, B3F-3122, B3F-3125

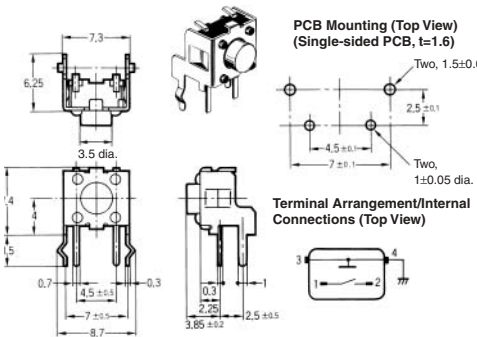

Vertical, Projected Plunger Type
B3F-3150, B3F-3152, B3F-3155

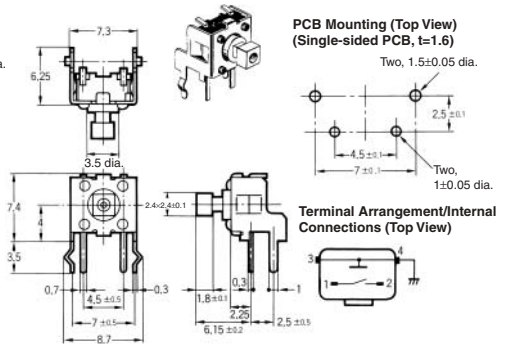

12 x 12 mm Models

Flat Plunger Type
(without Ground Terminal)

B3F-4000, B3F-4005,
B3F-5000, B3F-5001



PCB Mounting (Top View)
(Single-sided PCB, t=1.6)

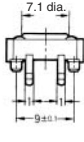
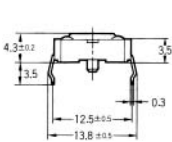
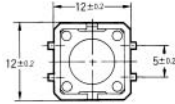
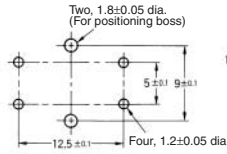

Terminal Arrangement/Internal
Connections (Top View)

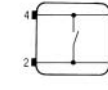

Flat Plunger Type
(with Ground Terminal)

B3F-4100, B3F-4105,
B3F-5100, B3F-5101



PCB Mounting (Top View)
(Single-sided PCB, t=1.6)

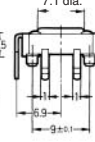
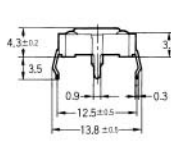
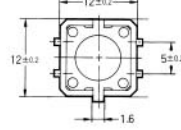
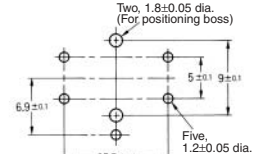

Terminal Arrangement/Internal
Connections (Top View)



Projected Plunger Type
(without Ground Terminal)

B3F-4050, B3F-4055,
B3F-5050, B3F-5051



PCB Mounting (Top View)
(Single-sided PCB, t=1.6)

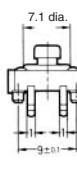
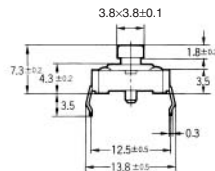
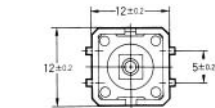
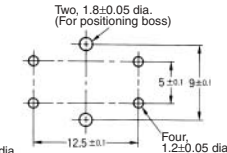

Terminal Arrangement/Internal
Connections (Top View)

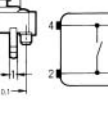

Projected Plunger Type
(with Ground Terminal)

B3F-4150, B3F-4155,
B3F-5150, B3F-5151



PCB Mounting (Top View)
(Single-sided PCB, t=1.6)

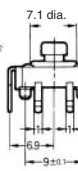
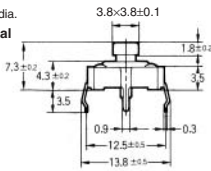
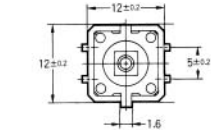
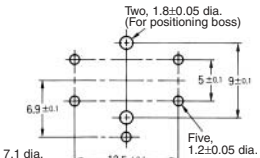

Terminal Arrangement/Internal
Connections (Top View)

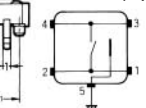

6 mm x 6 mm Radial Types (Taping Specifications): Sold in Units of 1,000 Switches

Flat Plunger Type (without Ground Terminal)
B3F-6000, B3F-6002

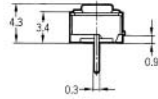
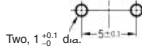
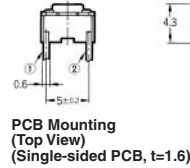
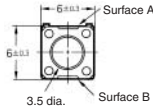
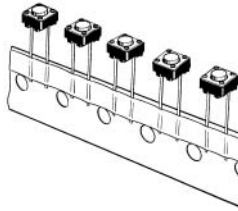

Terminal Arrangement / Internal Connections (Top View)

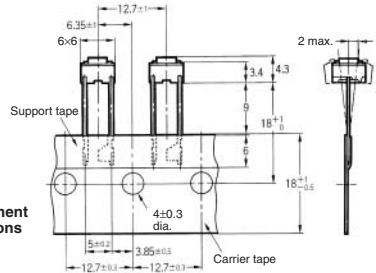
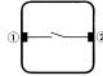

Note: The tape is random between surface A and surface B.

Flat Plunger Type (with Ground Terminal)
B3F-6100, B3F-6102

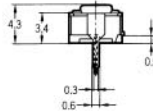
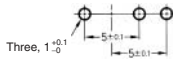
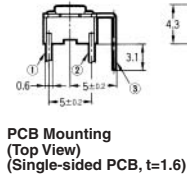
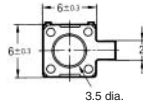
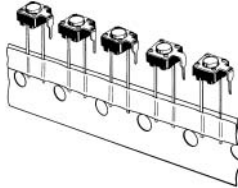

Terminal Arrangement / Internal Connections (Top View)

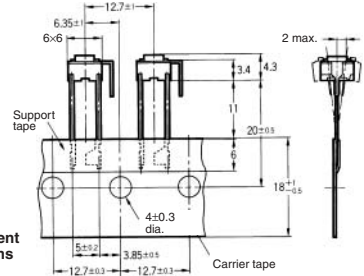
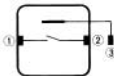

Flat Plunger Type (without Ground Terminal)
B3F-6020, B3F-6022

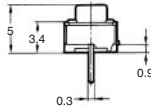
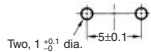
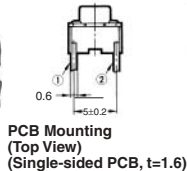
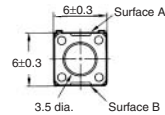
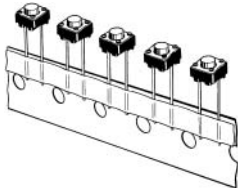

Terminal Arrangement / Internal Connections (Top View)

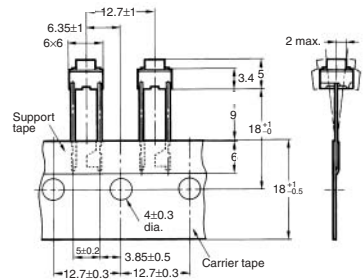
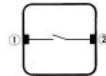

Note: The tape is random between surface A and surface B.

**Flat Plunger Type
(with Ground Terminal)**
B3F-6120, B3F-6122

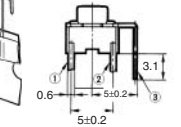
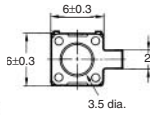
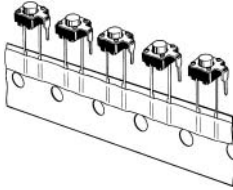

**PCB Mounting
(Top View)**
(Single-sided PCB, t=1.6)

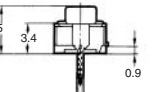
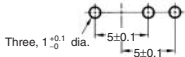

**Terminal Arrangement
(Top View)**

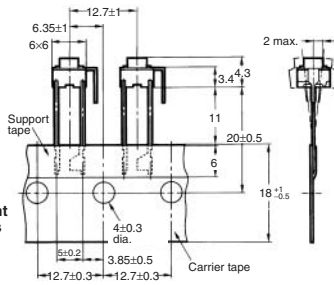

**Projected Plunger Type
(without Ground Terminal)**
B3F-6050, B3F-6052

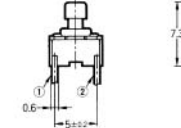
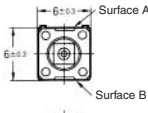
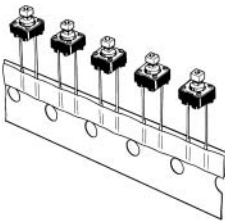

**PCB Mounting
(Top View)**
(Single-sided PCB, t=1.6)

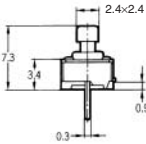
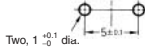

**Terminal Arrangement
(Top View)**

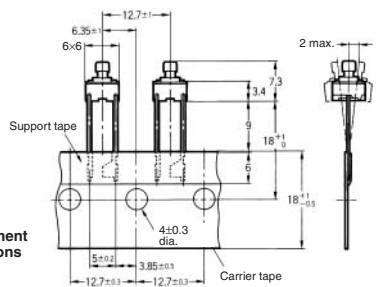

Note: The tape is random between surface A and surface B.

**Projected Plunger Type
(with Ground Terminal)**
B3F-6150, B3F-6152

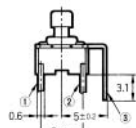
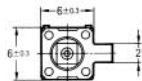
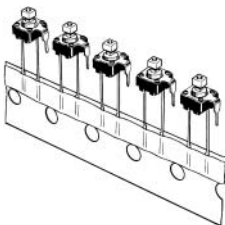

**PCB Mounting
(Top View)**
(Single-sided PCB, t=1.6)

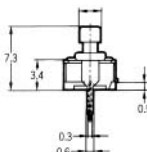
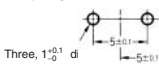

**Terminal Arrangement
(Top View)**

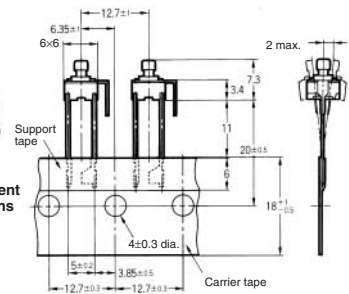
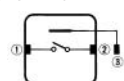

Key Tops

B32-series Special Key Tops are available for projected plunger models.