

Distinctive Characteristics

Wide selection of illumination effects is achieved with single and bicolor, 1- or 6-element LEDs, in flat, beveled, or sculptured caps. LED colors include red, amber, green, white, blue, and orange (achieved by lighting red and green simultaneously).

Combination of PCB mountability and short body allows use in compact applications.

Small behind panel dimension for snap-in mounting in tight spaces.

Snap-acting contact mechanism provides sensitive actuation with audible feedback; quick-make, quick-break characteristic limits arcing and prolongs electrical life.

Patented latchdown mechanism, independent of switching mechanism, gives outstanding stability and reliability plus visible and tactile indication of circuit status.

Terminals are epoxy sealed to lock out flux, solvents, and other contaminants.

Momentary and alternate action circuits available in the same space-saving body size.

Nonilluminated models available and shown in Pushbutton section.

Matching indicators available and shown in Indicator section.

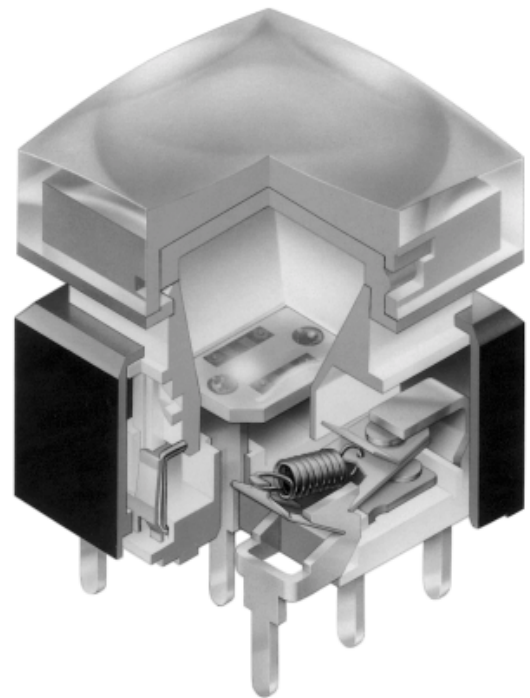

Actual Size

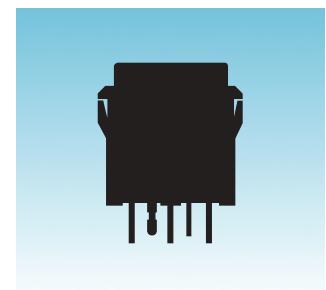

General Specifications

Electrical Capacity (Resistive Load)

Power Level (code W): 5A @ 125/250V AC or 5A @ 30V DC
Logic Level (code G): 0.4VA maximum @ 28V AC/DC maximum
 Note: See Supplement Index (page Z1) to find explanation of operating range.

Other Ratings

Contact Resistance: 50 milliohms maximum for silver; 100 milliohms maximum for gold
Insulation Resistance: 200 megohms minimum @ 500V DC
Dielectric Strength: 1,000V AC minimum between contacts for 1 minute minimum;
 1,500V AC minimum between contacts & case for 1 minute minimum
Mechanical Life: 1,000,000 operations minimum for momentary &
 200,000 operations minimum for alternate action
Electrical Life: 10,000 operations minimum for silver;
 200,000 operations minimum for gold
Nominal Operating Force: Single Pole: 194 grams
 Double Pole: 260 grams
Contact Timing: Break before make
Travel: 1.7mm (.067") pretravel; 0.6mm (.024") overtravel; 2.3mm (.091") total travel

Materials & Finishes

Housing/Bezel: Glass fiber reinforced polyamide
Snap-in Frame: Stainless steel
Movable Contactor: Phosphor bronze
Movable Contacts: Silver alloy or copper with gold plating
Stationary Contacts: Silver alloy or copper with gold plating
Switch Terminals: Phosphor bronze with silver or gold plating
Lamp Terminals: Brass with silver plating
Base: Glass fiber reinforced liquid crystal polymer

Environmental Data

Operating Temp Range: -25°C through +50°C (-13°F through +122°F) for Bright & Bicolor LEDs
 -20°C through +50°C (-4°F through +122°F) for Super Bright LEDs
Humidity: 90 ~ 95% humidity for 240 hours @ 40°C (104°F)
Vibration: 10 ~ 55Hz with peak-to-peak amplitude of 1.5mm traversing the frequency range
 & returning in 1 minute; 3 right angled directions for 2 hours
Shock: 50G (490m/s²) acceleration (tested in 6 right angled directions, with 5 shocks in each direction)

Installation

Cap Installation Force: 15.00N (3.37 lbf) maximum downward force on cap
Soldering Time & Temperature: 3 seconds @ 350°C or 5 seconds @ 270°C
Process Seal: Not available

Standards & Certifications

Flammability Standards: UL94V-0 rated base
UL & C-UL Recognized: All single & double pole models recognized at 5A @ 125/250V AC or
 0.014A @ 28V DC; UL File No. WOYR2.E44145 & C-UL File No. WOYR8.E44145;
 add "/U" to end of part number to order UL mark on switch & add "/U-C" to end of
 part number to order C-UL mark on switch (equivalent to CSA certification)



TYPICAL SWITCH ORDERING EXAMPLE

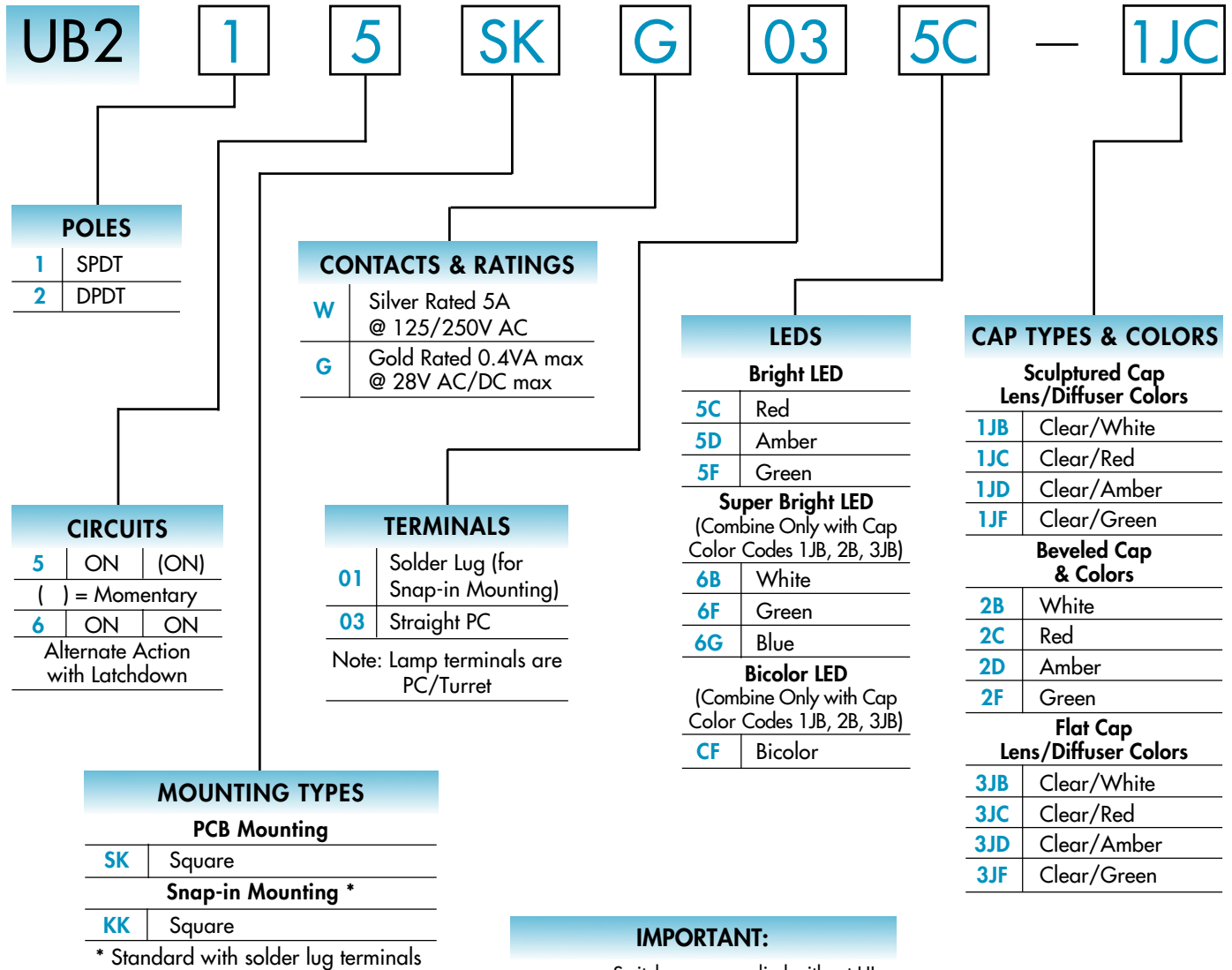

IMPORTANT:



Switches are supplied without UL & C-UL marking unless specified. Specific models & ratings noted on General Specifications page.

DESCRIPTION FOR TYPICAL ORDERING EXAMPLE

UB215SKG035C-1JC

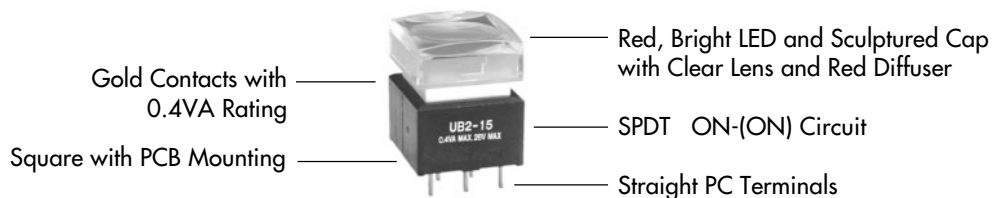

POLES & CIRCUITS

Pole	Model	Plunger Position () = Momentary		Connected Terminals		Throw & Schematics
		Normal	Down	Normal	Down	
SP	UB215 UB216*	ON ON	(ON) ON	1-3	1-2	SPDT Notes: Switch is marked with NC, NO, COM, L+ & L-.
DP	UB225 UB226*	ON ON	(ON) ON	1-3 4-6	1-2 4-5	DPDT

* When in latchdown position for the alternate circuit, cap positions above the housing are:
1.5mm (.059") for snap-in models & 7.0mm (.276") for PCB models.

SHAPES & MOUNTING TYPES

PCB Mounting

SK

Square

SP, Single Color LED

DP, Single Color LED

SP, Bicolor LED

DP, Bicolor LED

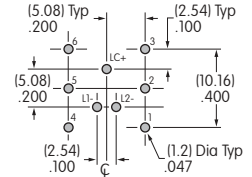
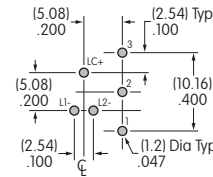
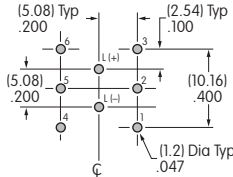
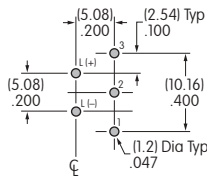
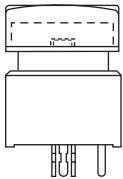

Snap-In Mounting (Solder Lug)

KK

Square with Bezel

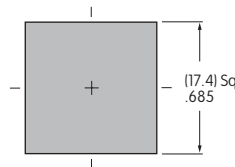
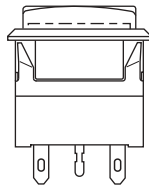

Panel Thickness
1.0 ~ 3.2mm
(.039 ~ .126")

CONTACT MATERIALS & RATINGS

W

Silver Contacts

Power Level

5A @ 125V AC & 250V AC

G

Gold Contacts

Logic Level

0.4VA maximum @ 28V AC/DC maximum

See Supplement Index (page Z1) for complete explanation of operating range.

TERMINALS

01

Solder Lug

.032" x .063" oblong hole accommodates two solid or stranded 24-gauge wires.

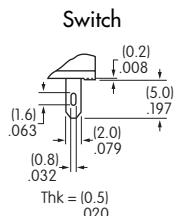

Lamp

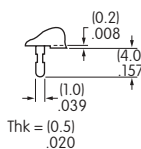

03

Straight PC

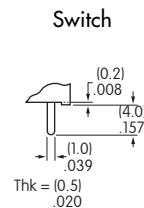

Lamp

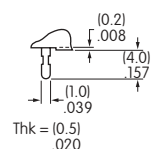

LED COLORS & SPECIFICATIONS

Electrical specifications are determined at a basic temperature of 25°C. LED circuit is independent of switch operation.
 If the source voltage is greater than rated voltage, a ballast resistor is required.
 The ballast resistor calculation and more lamp detail are shown in the Supplement; see Supplement Index (page Z1).

Bright, Super Bright, & Bicolor LEDs

Super Bright LED is Electrostatic Sensitive	Attention Electrostatic Sensitive Devices	Color	Bright LEDs			Units	Super Bright LEDs			Bicolor	Units
			5C Red	5D Amber	5F Green		6B White	6F Green	6G Blue	CF Red/Green	
Forward Peak Current		I_{FM}	30	30	25	mA	25	25	25	60/60	mA
Continuous Forward Current		I_F	20	20	20	mA	20	20	20	48/48	mA
Forward Voltage		V_F	1.85	2.0	2.1	V	3.6	3.5	3.6	1.8/2.0	V
Reverse Peak Voltage		V_{RM}	5	5	5	V	5	5	5	5/5	V
Current Reduction Rate Above 25°C		ΔI_F	0.40	0.42	0.46	mA/°C	0.40	0.40	0.40	1.0/1.0	mA/°C
Ambient Temperature Range			-25°C ~ +50°C				-20°C ~ +50°C			-25°C ~ +50°C	

Bright Single Color LED with 1 element



Super Bright Single Color LED with 1 element



Bicolor LED with 6 elements

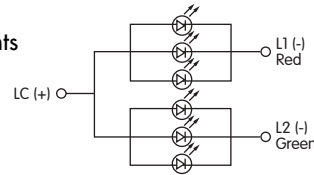

Super Bright and Bicolor LEDs combine only with cap color codes 1JB, 2B, and 3JB.

Orange color can be achieved by lighting red and green simultaneously on the bicolor LED.

CAP TYPES & COLOR COMBINATIONS

1 AT3074 Sculptured

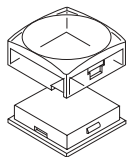
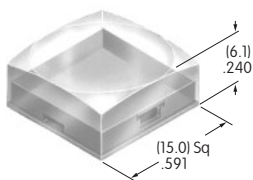

Clear Lens
Translucent Colored Diffuser

Lens/Diffuser Colors Available:

JB Clear/White	JD Clear/Amber
JC Clear/Red	JF Clear/Green

Material: Polycarbonate
Finish: Glossy

2 AT3075 Beveled

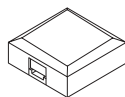
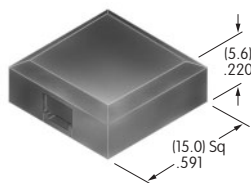

Translucent Colored Cap

Cap Colors Available:

B White	D Amber
C Red	F Green

Material: Polycarbonate
Finish: Glossy

3 AT3076 Flat

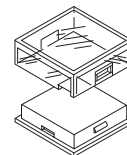
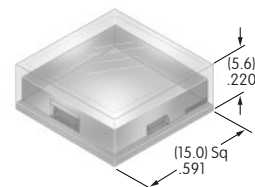

Clear Lens
Translucent Colored Diffuser

Lens/Diffuser Colors Available:

JB Clear/White	JD Clear/Amber
JC Clear/Red	JF Clear/Green

Material: Polycarbonate
Finish: Glossy

TYPICAL SWITCH DIMENSIONS

Single Pole • PCB Mount

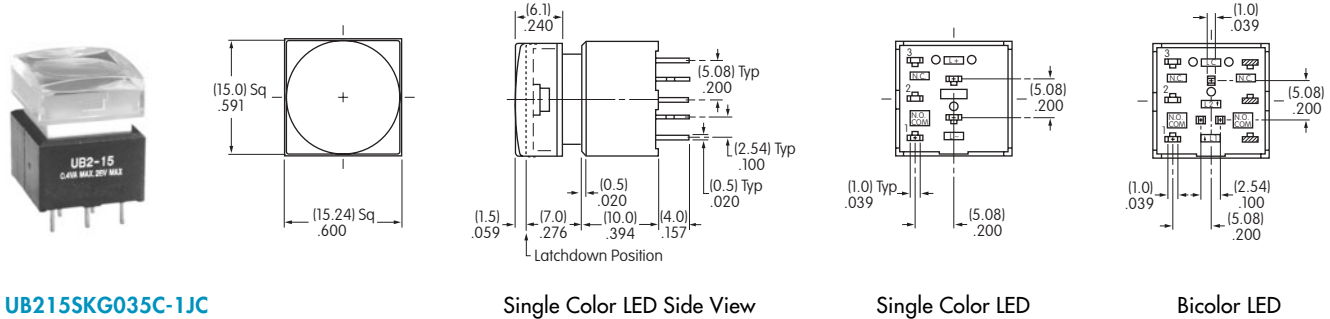

Double Pole • PCB Mount

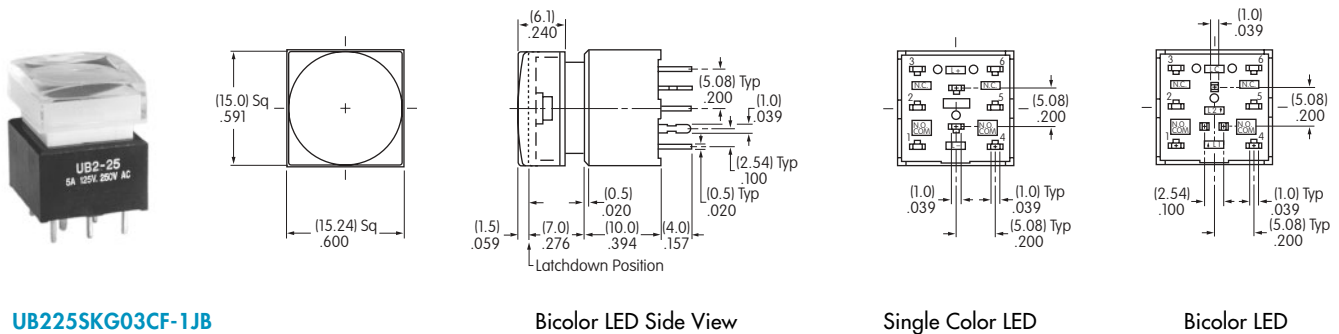

Single Pole • Snap-in Mount • Solder Lug

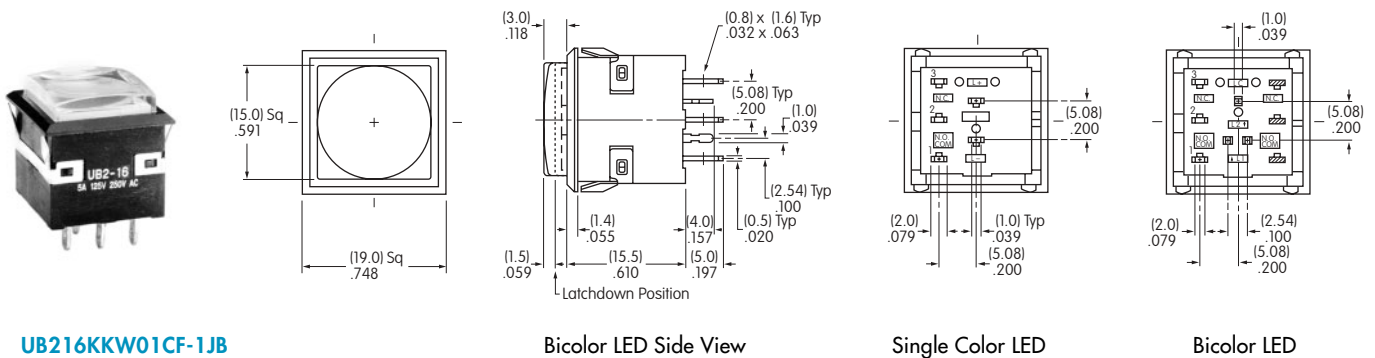

Double Pole • Snap-in Mount • Solder Lug

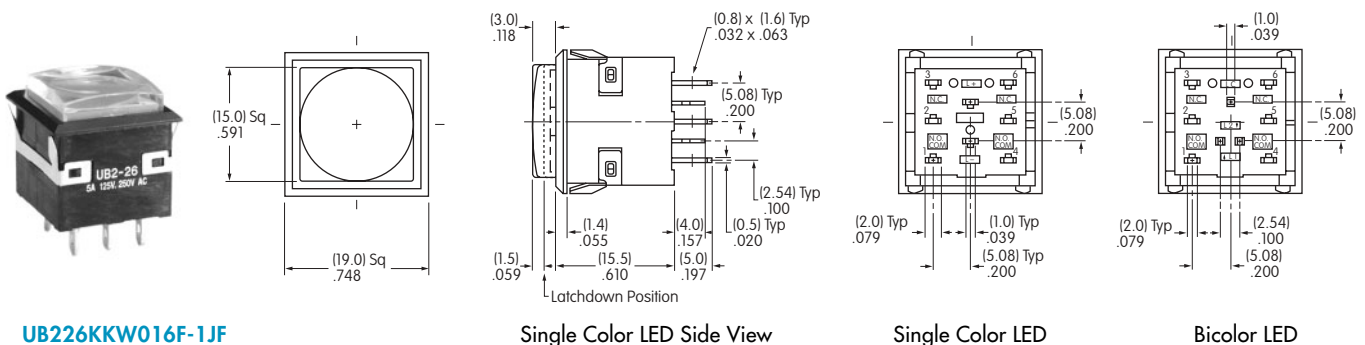

OPTIONAL ACCESSORIES

Protective Guard for Snap-in Mount

AT4141

Opens 90°
Closes manually

Materials:

Cover: Clear Polycarbonate
Base: Black GFR Polyamide

Recommended Panel Thickness:

1.0 ~ 2.7mm (.039" ~ .106")

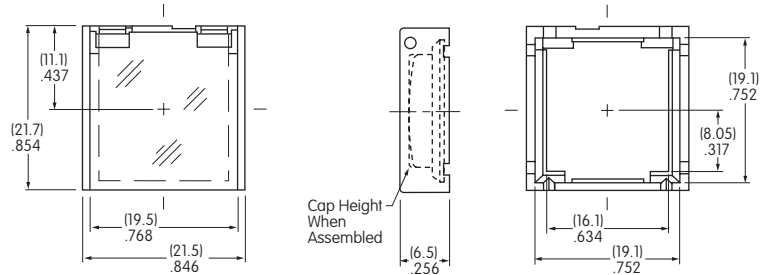
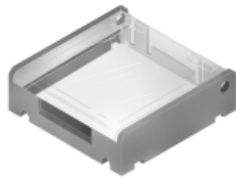

Spring Loaded Protective Guard for Snap-in Mounting of PCB Model

AT4170

Opens 180°
Closes Automatically

Materials:

Cover: Clear Polycarbonate
Base: Black Polyamide
Coil Spring: Stainless Steel

Recommended Panel Thickness:

1.0 ~ 3.2mm (.039" ~ .126")

Recommended Panel-to-PCB Range:

13.5 ~ 15.8mm (.531" ~ .622")

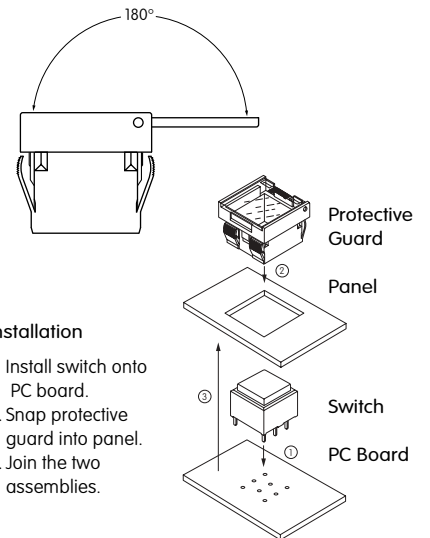
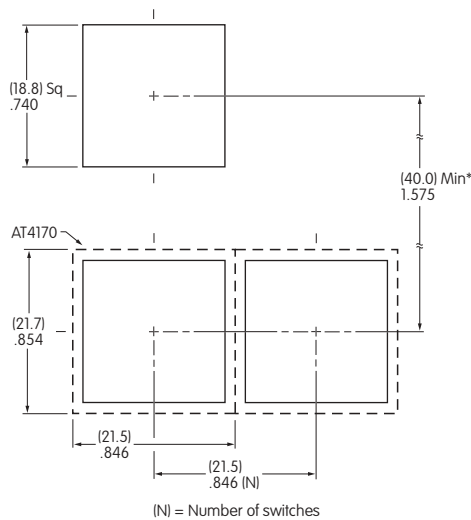
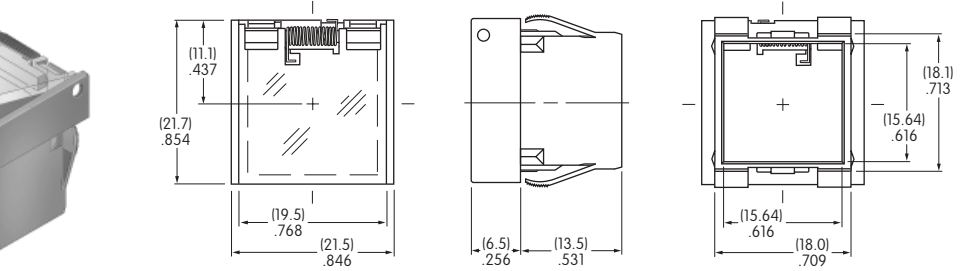
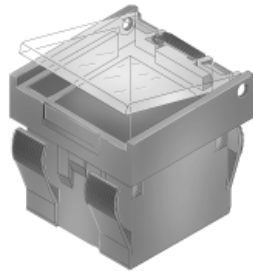

Spring Loaded Protective Guard for Snap-in Mount

AT4142

Opens 180°
Closes automatically

Materials:

Cover: Clear Polycarbonate
Base: Black GFR Polyamide
Coil Spring: Stainless Steel

Recommended Panel Thickness:

1.0 ~ 2.7mm (.039" ~ .106")

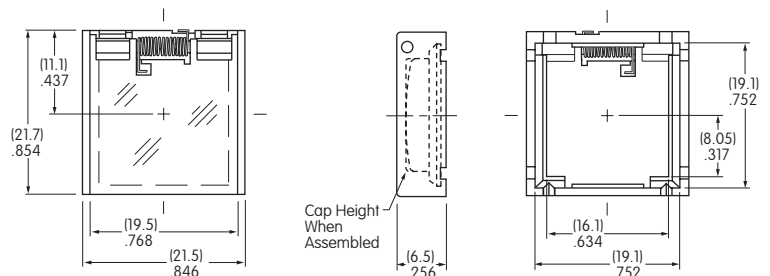

OPTIONAL ACCESSORIES

Splash Cover

AT4145 Square Not for use with barrier type models.

Materials:

Lid: Clear PVC

Operating temperature range:

0°C ~ +70°C (32°F ~ 158°C).

Gasket: Polyethylene

Recommended Panel Thickness

1.0mm ~ 2.5mm (.039" ~ .098")

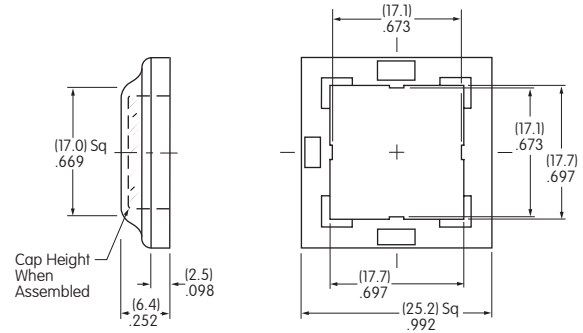
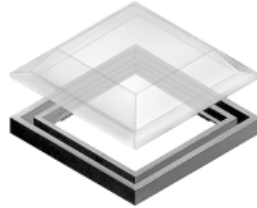

Barriers for Snap-in Mount

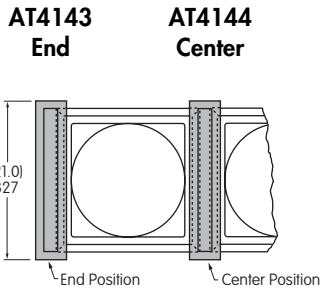

Material:
Polyamide

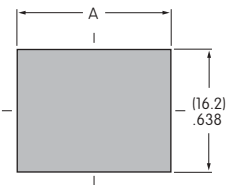
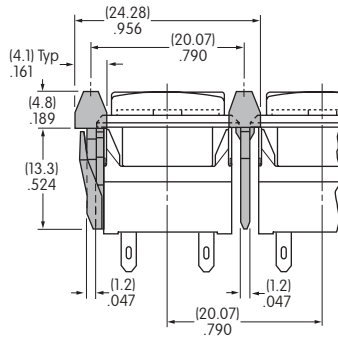

Cutouts for More Than 1 Switch:
 $A = .786" \times \text{Number of Switches} + .051"$

LEGENDS

General information and basic specifications are presented here for customers who want to do their own legends. Shaded areas are printable areas.

Beveled Cap

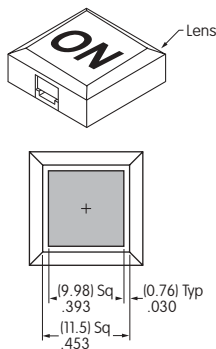

Flat Cap

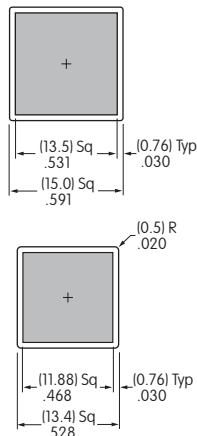

Sculptured Cap

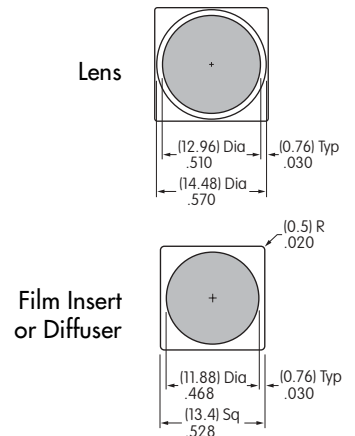

Recommended Print Methods:

Screen Print on Lens, Film Insert, or Diffuser; Pad Print on Lens. Epoxy based ink is recommended.

Film Insert: Clear Polyester
4 mil max. thickness

LEGEND PACKET



1. To order caps with legends, contact the factory and request the UB/UB2 Legend Packet.
2. Once you determine your desired legend, fill out the ordering work sheet included in the packet.
3. Return the completed work sheet to receive a quotation.