

RECOMMENDED PANEL MOUNTING

PANEL THICKNESS	X±0.05
0.75-1.25	29.6-29.7
1.25-2.00	30.1-30.2
2.00-3.00	30.45-30.55

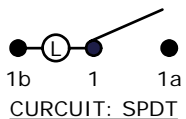

SWITCH FUNCTION	
POS. 1	POS. 2
ON	OFF
1-1a	OPEN

NOTES:

- ALL DIMENSIONS IN MM [INCH]
- GENERAL TOLERANCE: X.X=±0.4
X.XX=±0.25
- TERM. NOS. FOR REF. ONLY
- ▲ 4. RATING: 20A @ 125VAC
16A @ 250VAC (B)
- MATERIAL: BODY & ROCKER, NYLON 6/6 UL94 V-2
- LAMP VOLTAGE: NEON-250VAC
- ELECTRICAL LIFE: 10,000 CYCLES
- INSULATION RESISTANCE: 1,000 MEGA-OHMS
- ▲ DENOTES CRITICAL PARAMETER.
- 2002/95/EC (ROHS) COMPLIANT

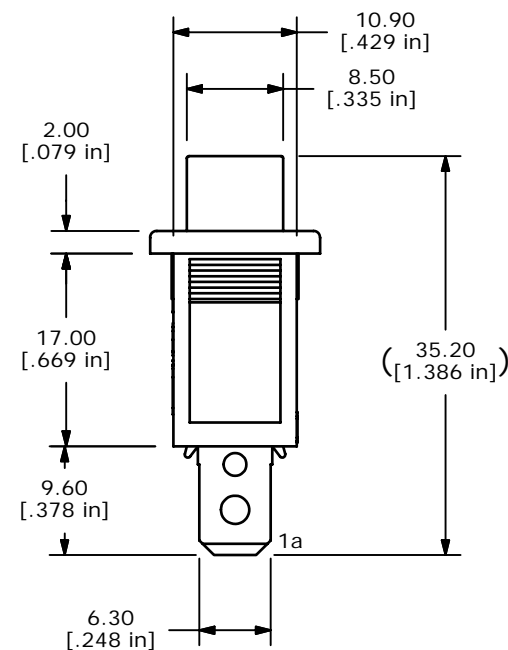
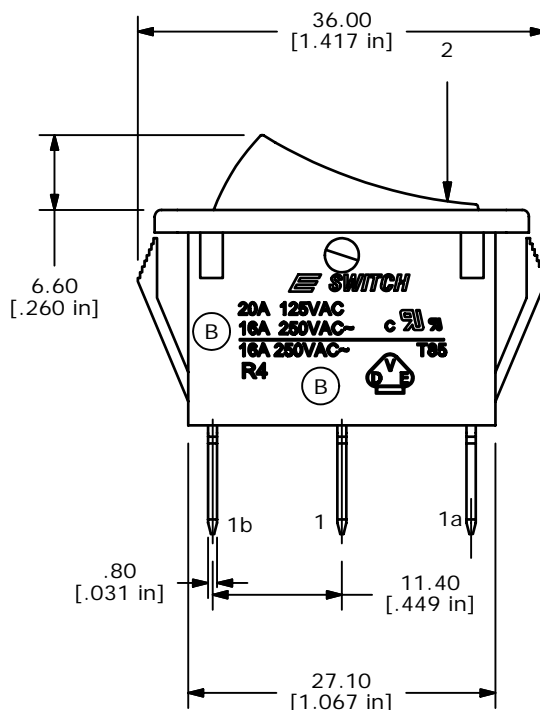
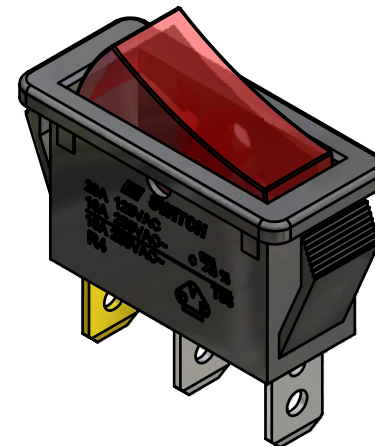
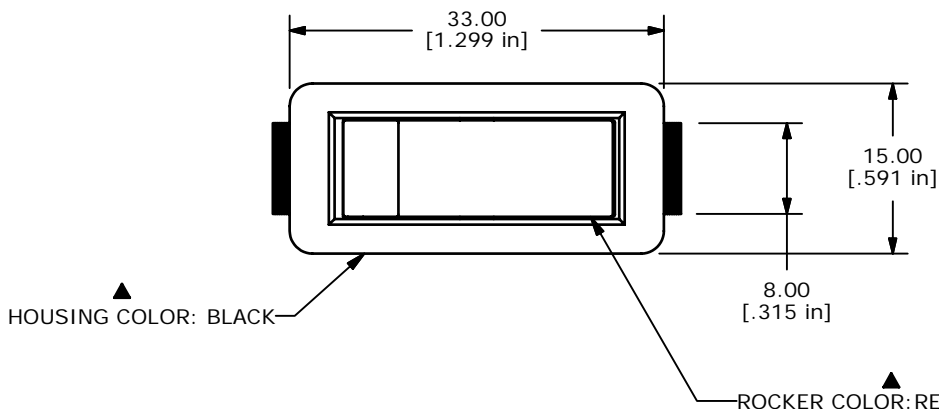

REV	PCR NO	DESCRIPTION	DATE	BY
B	15815	EDIT RATING	2/23/06	PH
A	15795	NEW RELEASE	2/20/06	PH

TITLE R4JBLKRILEF2				
SCALE 1:1	DATE 2/20/2006	DR PH	DWG M041001	REV B

THE INFORMATION CONTAINED IN THIS DOCUMENT IS PROPRIETARY TO E-SWITCH AND IS NOT TO BE COPIED OR TRANSFERRED