

DIMENSIONS IN INCHES (MILLIMETERS)  
DO NOT SCALE DRAWING

Dwg. No.

GRS-4012-0026

PANEL PIERCING

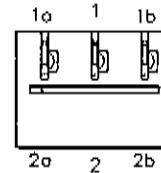
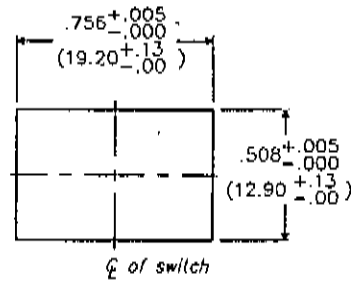
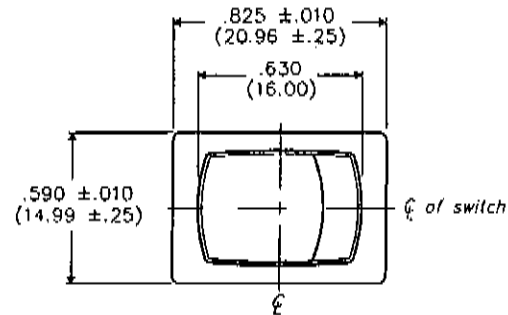

BOTTOM VIEW

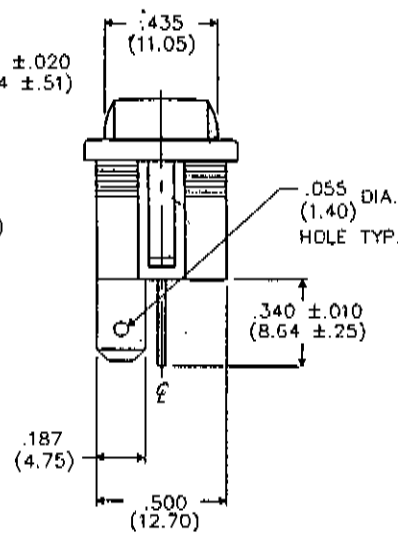
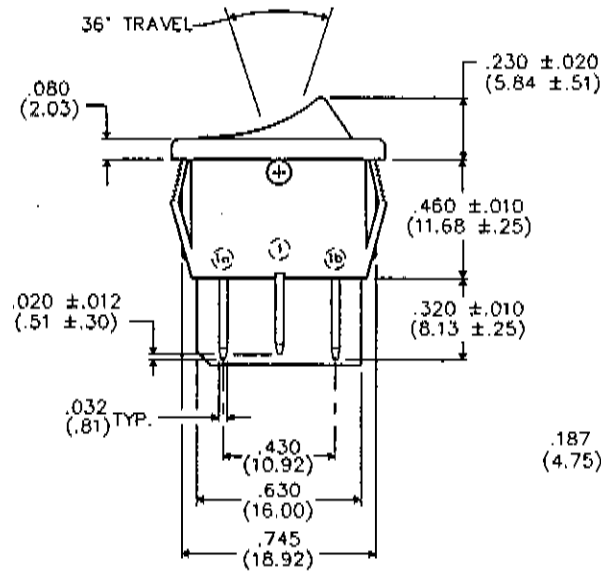

1 2 3 4 5 6 7 8 9 10

FORM-B4  
REVISIONS  
L-17-2002  
JAN 22 2002

**CW INDUSTRIES**  
Southampton, Pa. 18966

TOLERANCES UNLESS OTHERWISE SPECIFIED

2 Place Decimal ±.010	METRIC
3 Place Decimal ±.005	1 Place Dec. ±.25mm
Angles ..... ±1°	2 Place Dec. ±.10mm

Made for: CW IND.  
Drawn by: DGW 1-17-2002  
Checked by: G Guld 1-21-2002  
Approval: [Signature]

TITLE: **ROCKER SWIDGET ASSEMBLY (POP IN) S.P. - D.T.**

Division: **SWITCH**

Dwg. No. **GRS-4012-0026**

MASTER