

Whatever your application, our Contura switches deliver the performance you demand

— and the flexibility you need. There's no challenge these sealed switches can't help you address. Especially since they're IP66/IP68 certified, UL1500 recognized, and able to withstand temperatures from -40°C to +85°C. Never have such rugged switches been available in such attractive packages. A dazzling array of light, lens and legend options on several actuator styles, plus countless circuit combinations, and valuable accessories, make our Contura switches the ideal choice.

Maximum Design Options with minimum inventories

Panel redesign is a snap, requiring no tooling change, with our removable interchangeable actuators. A unique balance between aesthetics and functionality.

Withstands Extreme Temperatures

Roller pin mechanism eliminates need for lubricants, so it can withstand from -40°C to +85°C.

Seals out water, dust and debris

Dual seal protection locks out elements. Certified to IP66/IP68.

Clean Connections

Offered in both eight and ten terminal base options. AMP & Packard compatible connectors available.

Multiple Lighting Options

Incandescent lamps & LED illumination. Our LED illumination is offered in a wide array of light intensities, colors, as well as dual level illumination and flashing options.

Optional Panel Seal

Prevents water/dust egress behind panel.

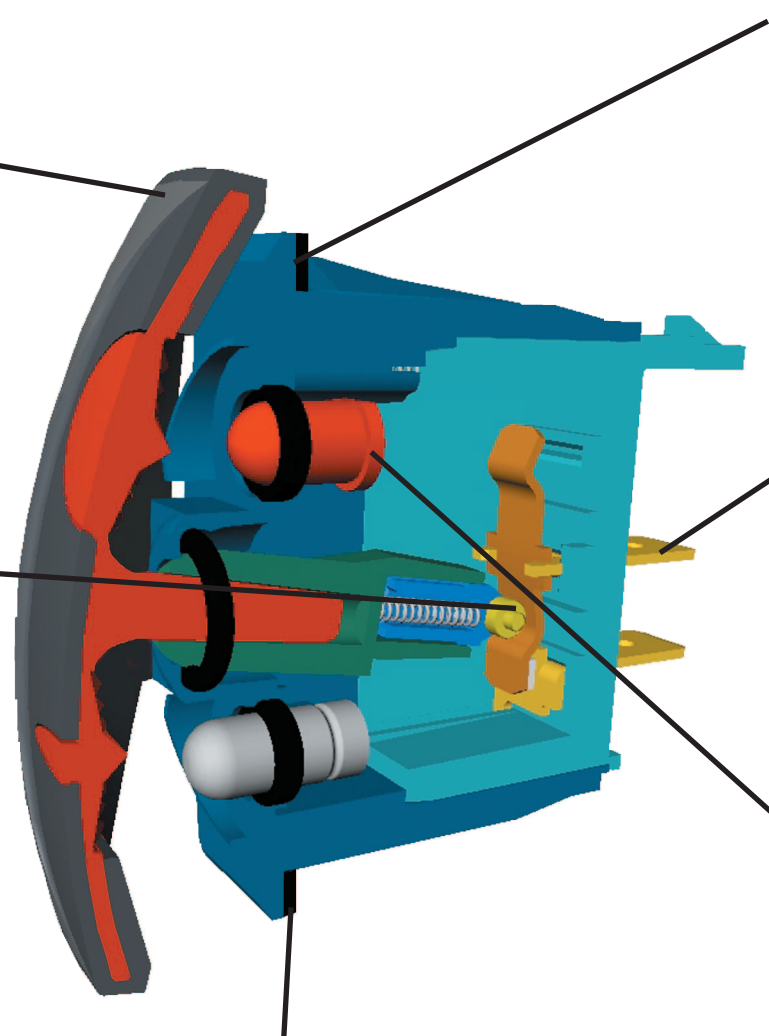

V-Series Contura Switches

V-Series switches offer countless unique options including choices for ratings, colors, illuminations and symbols. These switches feature removable actuators in a choice of actuator styles and colors, and are available in single or double pole configurations. The V-Series switches can be illuminated with either square, oval and/or bar shaped lenses.



Contura II

The Contura II actuators are constructed of thermoplastic polycarbonate, and are offered with either a hard nylon overlay, or a “soft-touch” elastomer overlay. The Contura II incorporates an aesthetic design of two rows of raised “bumps” on the top and bottom of the rocker.

Contura III

The Contura III actuators are constructed of thermoplastic polycarbonate, and are offered with either a hard nylon overlay, or a “soft-touch” elastomer overlay. The Contura III incorporates three rows of bars on the top and bottom of the rocker.

Contura IV

The Contura IV’s “Shape to create a Shape” actuator supports the designer, by working with the curves, contours and advanced styling of the latest panel designs, flowing with these advanced curves and radii. This actuator style fits on the Contura II & III flush bracket/bezel.

Contura V

The symmetrically curved Contura V actuator provides the perfect complement to the Contura IV’s “Shape to create a Shape” design concept. It can be mounted in between two Contura IV’s, by itself, or in groups. This actuator style is available with all flush style mounting brackets.



Contura X

The raised bracket/bezel on the Contura X helps prevent inadvertent actuation of the rocker, as well as preventing debris from being trapped under the actuator. The conventionally designed actuators are available with one-piece bar lenses, or square lenses in either one or two part construction with backlit legends, for increased durability of lens symbols.

Contura XI

The raised bracket/bezel on the Contura XI helps prevent inadvertent actuation of the rocker, as well as preventing debris from being trapped under the actuator. The actuators are available with one-piece bar lenses, or square lenses in either one or two part construction with backlit legends, for increased durability of lens symbols.

Contura XII

The Contura XII version incorporates a paddle style handle on the raised bracket/bezel, also used in the Contura X and XI switch. The contoured handle design provides intuitive recognition and ease of operation for a variety of transportation related applications, and is available with all Contura X and XI lens and legend offerings.

Illuminated Plug

The Illuminated Plug is offered with removable/replaceable lamps, Contura II, V and X styling, and LED illumination. As a critical safety feature, it’s illumination alerts the operator of essential system functions or malfunctions like: oil pressure, high temperature, transmission or other fluid levels, parking brake, or general system malfunction.

V-Series Accessories/Options

Carling Technologies also offers many V-Series accessories including connectors, mounting panels, hole plugs, panel seals, and actuator removal tools.

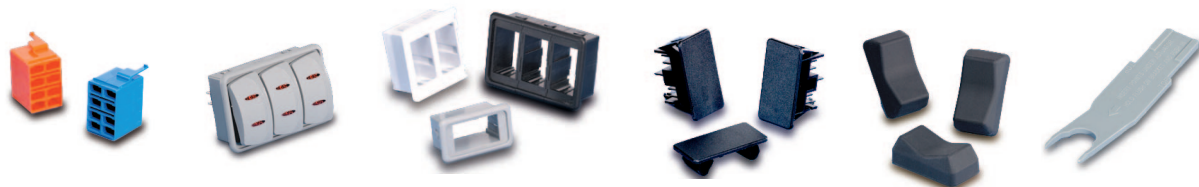

Electrical

Contact Rating4VA @ 24VDC (MAX) resistive 15 amps, 125 VAC 10 amps, 250 VAC 1/2 HP 125-250 VAC 20 amps, 4-14 VDC 15 amps, 15-28 VDC 10A 14VT 6A 125 VAC L
Dielectric Strength	1500 Volts RMS
Insulation Resistance . . .	50 Megohms
Initial Contact Resistance.	10 milliohms max. @ 4 VDC
Life	50,000- 100,000 cycles circuit dependent
Contacts	Silver cad-oxide, silver tin-oxide, fine silver
Terminals	Brass or copper/silver plate 1/4" (6.3mm) Quick Connect terminations standard. Solder lug, Wire Lead

Mechanical

Endurance	150,000 cycles minimum
---------------------	------------------------

Physical

Lighted	Incandescent - rated 10,000 hours Neon - rated 25,000 hours LED - rated 100,000 hours 1/2 life (LED is internally ballasted for voltages to 24 VDC)
Seals	Internal Optional external gasket panel seal
Base	Polyester blend rated to 125C with a UL flammability rating of 94 V-O.
Contura II, III, IV, V Actuator	Hard Surface: Basic actuator structure molded of thermoplastic polycarbonate with a hard Nylon 66 thermoplastic surface overlay. Soft Surface: Basic actuator structure molded of thermoplastic polycarbonate with an elastomer overlay.
Contura X, XI, XII Actuator, VP	Nylon 66 Reinforced rated to 105°C
Lens	Polycarbonate rated at 100°C

Actuator Travel (Angular Displacement)

2 position	18°
3 positions	9° from center

Mounting Specifications

Panel Thickness Range	
# of gaskets	Acceptable Panel Thickness
0	.030 to .250 (.76mm to 4.76mm)
1	.030 to .109 & .147 to .157 (.76 to 2.77mm & 3.73 to 3.98mm)
Recommended: No gasket with panel thickness of .032, .062, .093, .125, .187 or .250	

Agency Certifications

Environmental

Environmental	Sealed version: IP68, in accordance with IEC 529, BS 5490, DIN 400 50 & NFC 20 010. This rating applies to front panel components and signifies protection against dust and the prolonged effects of immersion under pressure. The standard test for immersion under pressure requires submersion under one meter of water for 30 minutes. The V-Series switch has exceeded these parameters, having been actuated and illuminated during submersion. NOTE: Sealed switch with optional panel gasket will meet IP67 rating.
Corrosion	Flowing Mixed Gas (FMG) Class III 3 year accelerated exposure per ASTM B-827, B-845 Silver and gold contacts
Operating Temperature . .	-40° C to + 85° C
Vibration 1	Per Mil-Std 202F, Method 204D Test Condition A 0.06 DA or 10G's 10-500 Hz. Tested with VCH connector. Test criteria - No loss of circuit during test and pre and post test contact resistance.
Vibration 2	Resonance search 24-50 Hz 0.40 DA 50-2000 ±10 G's peak Results Horizontal Axis 3-5 G's max. Random 24 Hz 0.06 PSD-Gsq/Hz 60 Hz 0.50 100 Hz 0.50 200 Hz 0.025 2000 Hz 0.025 No loss of circuit during test; <10µ seconds chatter.
Shock	Per Mil-Std 202F, Method 213B, Test Condition K @ 30G's. Tested with VCH connector. Test criteria - No loss of circuit during test, pre and post test contact resistance.
Salt Spray	Per Mil-Std 202F, Method 101D, Test Condition A, 48 Hrs. Sealed version only.
Dust	Per Mil-Std 810C, Method 510.2 Air Velocity 300 ±200 Feet/Min, Test Duration 16 Hrs.
Thermal Shock	Per Mil-Std 202F, Method 107F, Test Condition A, -55°C to 85°C. Test criteria - pre and post test contact resistance
Moisture Resistance	Per Mil-Std 202F, Method 106F, Test Criteria - pre and post test contact resistance
Ignition Protection	All Contura switches with sealed construction meet the requirements of UL1500/ISO8846 for ignition protection, in addition to conformance with EC directive 94/25/EC for marine products.

Dimensional Specifications: in. [mm]

CONTURA II STYLE

SHOWN WITH SQUARE LENS

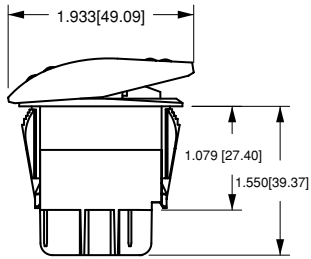
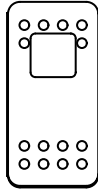

8 TERMINAL BASE W/BARRIERS

CONTURA III STYLE

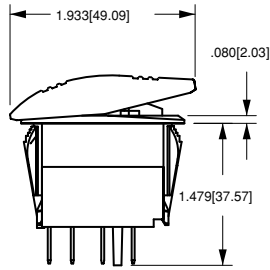
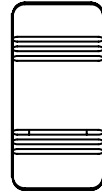

8 TERMINAL BASE W/O BARRIERS

CONTURA IV & V STYLE

IV - SHOWN WITH BAR LENS

V - SHOWN WITH ROUND LENS

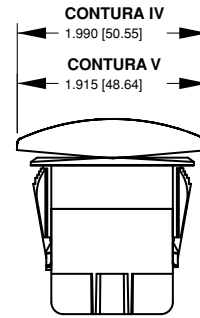
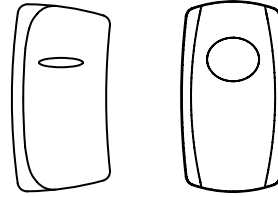

10 TERMINAL BASE W/BARRIERS

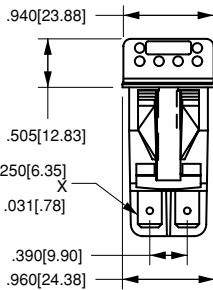

8 TERMINAL BASE W/BARRIERS

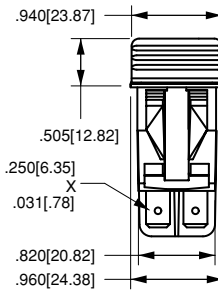

10 TERMINAL BASE W/O BARRIERS

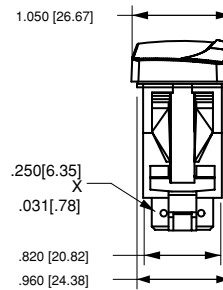

10 TERMINAL BASE W/O BARRIERS

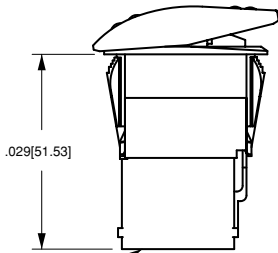

SWITCH SHOWN WITH VCH CONNECTOR 8 TERMINAL

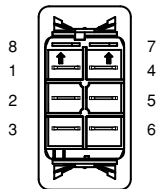

BOTTOM VIEW TERMINAL ARRANGEMENT 8 TERMINAL BASE

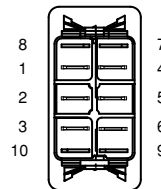

BOTTOM VIEW TERMINAL ARRANGEMENT 10 TERMINAL BASE

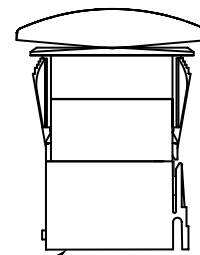

SWITCH SHOWN WITH VC1 CONNECTOR 10 TERMINAL

Dimensional Specifications: in. [mm]

CONTURA X STYLE
SHOWN WITH RAISED BRACKET

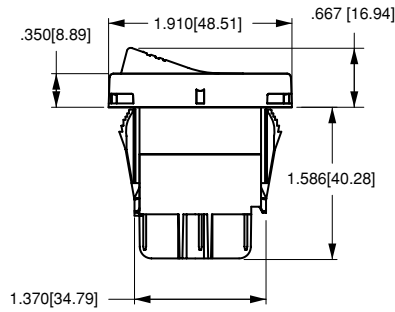
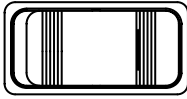

8 TERMINAL BASE W/BARRIERS

CONTURA XI STYLE
SHOWN WITH RAISED BRACKET AND TWO SQUARE LENSES

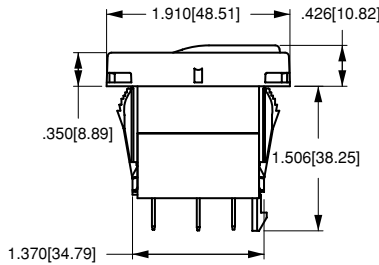
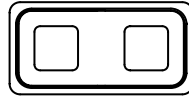

10 TERMINAL BASE W/O BARRIERS

CONTURA XII STYLE
SHOWN WITH PADDLE ACTUATOR

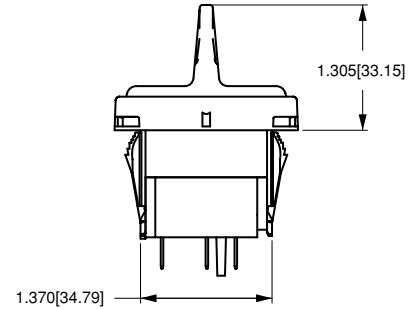
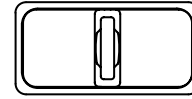

8 TERMINAL BASE W/O BARRIERS

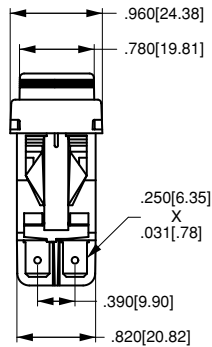

8 TERMINAL BASE W/BARRIERS

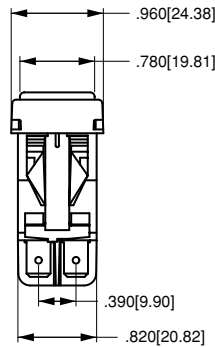

10 TERMINAL BASE W/BARRIERS

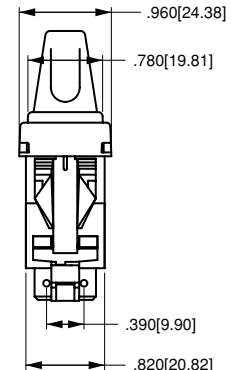

10 TERMINAL BASE W/O BARRIERS

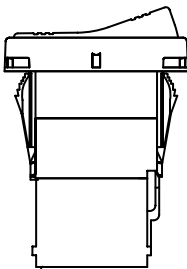

SWITCH SHOWN WITH VCH CONNECTOR 8 TERMINAL

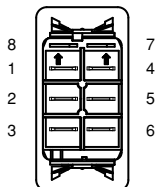

BOTTOM VIEW TERMINAL ARRANGEMENT 8 TERMINAL BASE

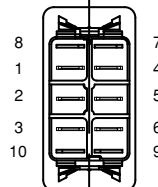

BOTTOM VIEW TERMINAL ARRANGEMENT 10 TERMINAL BASE

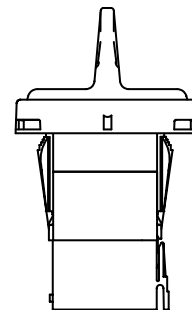

SWITCH SHOWN WITH VC1 CONNECTOR 10 TERMINAL

V 1 D A B 6 0 1 - 6 P Z 00 - 0 00

1 Series 2 Circuit 3 Rating 4 Termination Illumination 5 Lamp 6 Lamp 7 Lamp 8 Bracket 9 Actuator 10 Lens 11 Lens 12 Legend 13 Legend Orientation 14 Actuator Lens Legend

1 SERIES
V

2 CIRCUIT
Terminal Connections as viewed from bottom of switch:
8 terminal 10 terminal
8 - -7 8 - -7
1 - -4 1 - -4
2 - -5 2 - -5
3 - -6 3 - -6
10 - -9

() - momentary
SP - single pole - uses terminals 1, 2 & 3.
DP - double pole uses terminals 1, 2, 3, 4, 5 & 6.
Terminals 7, 8, 9 & 10 for lamp circuit only.

Position:	1	2	3
SP	DP	2 & 3, 5 & 6	Connected Terminals
1	A	ON	NONE
2	B	(ON)	NONE
3	C	ON	NONE
4	D	ON	NONE
5	F	ON	NONE
6	J	ON	OFF
7	L	(ON)	OFF
8	K	(ON)	OFF

SPECIAL CIRCUITS

	2 & 3	2 & 3, 5 & 4	5 & 4
H*	2 & 3	2 & 3	OFF
G*	2 & 3, 5 & 6	2 & 3	1 & 2
S	2 & 3, 5 & 6	2 & 3	OFF
M*	(2 & 3, 5 & 6)	2 & 3	1 & 2
R	(2 & 3, 5 & 6)	2 & 3	5 & 4
E*	5 & 6	5 & 3	5 & 4

* Jumper between terminals 2 & 5 for circuits H, G, & M are specified in selection 4.
External jumper between terminals 2 & 4 for circuit E are provided by customer. Circuit E may be used for SP OFF-ON-ON circuit. Circuits H, M & E not available with ratings 5 - 9.

3 RATING*

1 .4VA @ 28VDC Resistive
4 10A 250VAC 1/2 HP, 15A 125VAC 1/2 HP, No Listings
5 10A 250VAC 1/2 HP, 15A 125VAC 1/2 HP, UL Recognized, CSA Certified
8* 10A 250VAC, 15A 125VAC, 1/2 HP 125-250VAC, 12(2)A 250 VAC μ T85
9* 10A 250VAC, 15A 125VAC, 1/2 HP 125-250 VAC, 12(6)A 250 VAC T85
B 15A 24V
C 20A 18V
D 20A 12V

* Ratings 8 & 9 are UL, CSA, VDE, DEMKO, SEMKO, NEMKO, FIMKO & BEAB certified, require terminations A or B for double pole circuits, & are not available with illumination circuits 4, 8, D, J, N, & T or with wire lead or solder lug terminations. Circuits 1, 4, A & D are not available with rating 8. Rating 9 only available with circuits 1, 4, A & D. Ratings 8 & 9 must specify lamp code 2 (250VAC neon).

4 TERMINATION/BASE STYLE

8 term	10 term	Termination	Jumper
1	2	.250 TAB (QC) no barriers	No
A	B	.250 TAB (QC) with barriers	No
J	K	.250 TAB (QC) no barriers	Yes T2 to 5
3	4	Solder Lug no barriers	No
C	D	Solder Lug	No
5	F	Wire Leads no barriers	No
E	F	Wire Leads	No

Note: Codes J & K for circuits H, G & M. Ratings 8 & 9 require terminations A or B only.

5 ILLUMINATION & SWITCH SEALING
Lamp #1: above terminals 1 & 4 end of switch.; Lamp #2 above terminals 3 & 6 end of switch.
Positive (+) and negative (-) symbols apply to LED lamps only

Sealed	Unsealed	Lamps	Actuator Lens position when Illuminated	Lamp wired to Terminals
S	0	None		
A	1	# 1	Independent	8+ 7-
B	2	# 1	Down	3+ 7-
C	3	# 2	Up	3+ 7-
D	4	# 1	Down	3+ 7-
E	5	& # 2	Down	1+ 7-
F	6	# 1	Up	1+ 7-
G	7	& # 2	Up	3+ 7-
H	Z	# 1	Independent	8+ 7-
U	Y	# 1	Independent	8+ 7-
		& # 2	Independent	10+ 9-

Selections for Single Pole Switches Only:

J	8	# 1	Down	3+ 8-
K	W	& # 2	Independent	6+ 7-
		# 1	Independent	8+ 7-
		& # 2	Independent	6+ 7-

Selections for Double Pole Switches Only:

L	9	# 1	Down	3+ 6-
M	R	# 2	Up	3+ 6-
N	T	# 1	Down	3+ 6-
		& # 2	Down	1+ 4-
P	V	# 1	Up	1+ 4-
		& # 2	Up	3+ 6-
U	Y	# 1	Independent	8+ 7-
		& # 2	Independent	10+ 9-

6,7 LAMP (same coding for both selections)
Selection 6: above terminals 1 & 4; Selection 7: above terminals 3 & 6

No lamp 0
Neon 1 125VAC 2 250VAC
Incandescent 4 3V 5 6V 6 12V 7 18V 8 24V
LED*
2VDC A Red L Amber F Green R superbright
6VDC B C M G H S Red
12VDC C N H T
24VDC D P J V

* Consult factory for "daylight bright" LED options. Typical current draw for LED is 20ma.

8 BRACKET COLOR¹, PANEL SEAL (external foam gasket)

# of gaskets	X & XI w/Flush Bracket	X, XI, XII w/Raised Bracket
Black	B	C
White	W	Y
Gray	G	H

9 ACTUATOR

No Actuator	Black	Gray	White	Red
Contura X	1	2	3	4
Contura XI	6	7	8	9
Contura XII	J	K	N	M

Actuator orientation above terminals: 3,6 1,4

10 LENS - above lamp #1 terminals 1,4
11 LENS - above lamp #2 terminals 3,6
Lens color for LEDs must be clear, white, or match color of LED.
Green or blue lenses are not recommended with Neon lamps.

0 - No Actuator	Z - No Lens	Lens Style
Clear	White	Bar
3	8	D
4	9	E
5	A	F
		J
		K
		L
		M
		N
		O
		P
		Q
		R
		S
		T
		U
		V
		W
		X
		Y

One piece Square
Two piece Square*
(w/ clear top protective lens)
Two piece Square*
(w/ smoke top protective lens)
Two piece Square*
(w/ white top protective lens)

* All bottom lenses are molded of opaque material. Consult factory for other lens colors.

12 ACTUATOR LENS OR BODY LEGEND²

00	No Legend this location/No actuator			
11	ON	12 OFF	13 I	14 O
15	O O	16 O O	17 O I	18 I O
	F N	N F	O	I
	F	F		
21	OFF	22 ON	23 O	24 I
25	O	26 O	27 O	28 I
	F	N		
	F			

For additional legend options & codes, see page 69 of this catalog

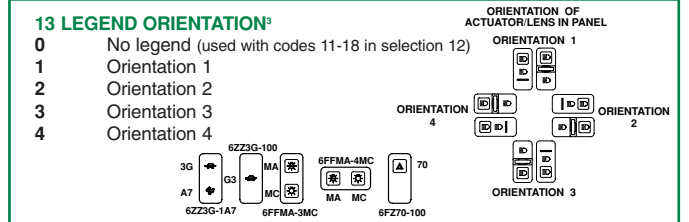

14 ACTUATOR LENS LEGEND

00 No legend this location/no actuator (used with codes 11-18 in selection 12)

Selection 14 required when switch requires two legends. If the two legends consist of one lens & one body legend, lens legend must be specified in selection 12; body legend specified in selection 14. For legend options & codes, see page 69 of this catalog.

NOTES
Consult factory to verify horsepower rating for your particular circuit choice.
1 Custom colors are available. Consult factory.
2 White imprinting is standard on black actuators; Black imprinting is standard on white, red & gray actuators. Custom colors are available, consult factory.
3 With 2 square lenses, use sel. 12 for lens above lamp 1, & selection 14 for lens above lamp 2.
4 Additional ratings available. See page 57.
5 Not available with Contura XI rockers.

V 1 D A S W O 1 - 1 P B 00 - 0

1 Series 2 Circuit 3 Rating 4 Termination 5 Illumination 6 Lock 7 Lamp 8 Bracket 9 Actuator 10 Lens 11 Function 12 Legend 13 Legend Orientation

1 SERIES
V

2 CIRCUIT
Terminal Connections as viewed from bottom of switch:
8 terminal 10 terminal
8 - -7 8 - -7
1 - -4 1 - -4
2 - -5 2 - -5
3 - -6 3 - -6
10 - -9

() - momentary
SP - single pole - uses terminals 1, 2 & 3.
DP - double pole uses terminals 1, 2, 3, 4, 5 & 6.
Terminals 7, 8, 9 & 10 for lamp circuit only.

Position:

SP	DP	2 & 3, 5 & 6	Connected Terminals	1 & 2, 4 & 5
1 A	ON		NONE	OFF
4 D	ON		NONE	ON
6 J	ON		OFF	ON
7 K	ON		OFF	(ON)
8 L	(ON)		OFF	(ON)
9 N	OFF		NONE	(ON)

SPECIAL CIRCUITS

H*	2 & 3	2 & 3, 5 & 4	5 & 4
G*	2 & 3, 5 & 6	2 & 3	OFF
S	2 & 3, 5 & 6	2 & 3	1 & 2
M*	(2 & 3, 5 & 6)	2 & 3	OFF
R*	(2 & 3, 5 & 6)	2 & 3	1 & 2
E*	5 & 6	5 & 3	5 & 1

* Jumper between terminals 2 & 5 for circuits H, G, & M are specified in selection 4.
External jumper between terminals 2 & 4 for circuit E are provided by customer. Circuit E may be used for SP OFF-ON-ON circuit. Circuits H, M & E not available with ratings 5, 8 & 9.

3 RATING⁵

1 .4VA @ 28VDC Resistive
4 10A 250VAC 1/2 HP, 15A 125VAC 1/2 HP, No Listings
5 10A 250VAC 1/2 HP, 15A 125VAC 1/2 HP, UL Recognized, CSA Certified
8* 10A 250VAC, 15A 125VAC, 1/2 HP 125-250VAC, 12(2)A 250 VAC μ T85
9* 10A 250VAC, 15A 125VAC, 1/2 HP 125-250 VAC, 12(6)A 250 VAC T85
B 15A 24V
C 20A 18V
D 20A 12V

* Ratings 8 & 9 are UL, CSA, VDE, DEMKO, SEMKO, NEMKO, FIMKO & BEAB certified, require terminations A or B for double pole circuits, & are not available with illumination circuits 4, 8, D, J, N, & T or with wire lead or solder lug terminations. Circuits 1, 4, A & D are not available with rating 8. Rating 9 only available with circuits 1,4,A & D. Ratings 8 & 9 must specify lamp code 2 (250VAC neon).

4 TERMINATION/BASE STYLE

8 term	10 term	Termination	Jumper
1	2	.250 TAB (QC) no barriers	No
A	B	.250 TAB (QC) with barriers	No
J	K	.250 TAB (QC) no barriers	Yes T2 to 5
3	4	Solder Lug no barriers	No
C	D	Solder Lug	No
5	6	Wire Leads no barriers	No
E	F	Wire Leads	No

Note: Codes J & K for circuits H, G & M. Ratings 8 & 9 require terminations A or B only.

5 ILLUMINATION & SWITCH SEALING
Lamp above terminals 3 & 6 end of switch.
Positive (+) and negative (-) symbols apply to LED lamps only

Sealed	Unsealed	Lamps	Actuator Lens position when illuminated	Lamp wired to Terminals
0	0	None	Up	3+ 7-
3	Z	#2	Independent	8+ 7-
Selections for Double Pole Switches Only:				
M	R	#2	Up	3+ 6-

6 LOCK
Lock above terminals 1 & 4 end of switch.
W lock

NOTES
Consult factory to verify horsepower rating for your particular circuit choice.

- 1 Custom colors are available. Consult factory.
- 2 White imprinting is standard on black actuators; Black imprinting is standard on white, red and gray actuators; Custom colors are available, consult factory.
- 3 Located over T1-4 end of switch.
- 4 Only available with 3 position circuits. Center OFF and special circuits only available with center position lock function.
- 5 Additional ratings available. See page 57.

7 LAMP
Lamp above terminals 3 & 6 end of switch.
No lamp 0
Neon 1 125VAC 2 250VAC
Incandescent 4 3V 5 6V 6 12V 7 18V 8 24V
LED* Red Amber superbright Green superbright Red

2VDC	A	L	F	R
6VDC	B	M	G	S
12VDC	C	N	H	T
24VDC	D	P	J	V

* Consult factory for "daylight bright" LED options. Typical current draw for LED is 20ma.

8 RAISED BRACKET COLOR¹, PANEL SEAL (external foam gasket)

	Black	White	Gray
No Gasket	1	2	3
One Gasket	4	5	6

9 HARD SURFACE ACTUATOR¹

	Black	Gray	Red	White
Contura X	1	2	3	4

Actuator orientation above terminals: 3,6 1,4

10 LENS - above lamp #2 terminals 3,6
Z - No Lens

Clear	White	Amber	Green	Red	Blue	Lens Style
3	8	D	J	P	V	Bar
4	9	E	K	R	W	One piece Square
5	A	F	L	S	Y	Two piece Square*
(w/ clear top protective lens)						
2	7	C	H	N	U	Two piece Square*
(w/ smoke top protective lens)						
1	6	B	G	M	T	Two piece Square*
(w/ white top protective lens)						

* All bottom lenses are molded of opaque material. Consult factory for other lens colors.
Lens color for LEDs must be clear, white, or match color of LED.
Green or blue lenses are not recommended with Neon lamps.

11 ACTUATOR LOCK FUNCTION AND COLOR³

Lock Color	Up	Down	Up & Down	Center ⁴
Match Actuator	A	H	R	1
Black	B	J	S	2
White	C	K	T	3
Red	D	L	V	4
Safety Orange	E	M	W	5

12 ACTUATOR, LENS OR BODY LEGENDS²
00 - No Legend

21	22	23	24
OFF	ON	O	I
25	26	27	28
O	O	O	I
F	N		

For additional legend options & codes, see page 69 of this catalog

13 LEGEND ORIENTATION³
0 No legend (used with codes 11-18 in selection 12)

ORIENTATION OF ACTUATOR/LENS IN PANEL

1 Orientation 1
2 Orientation 2
3 Orientation 3
4 Orientation 4

ORIENTATION 1

ORIENTATION 4

ORIENTATION 5

13DMC-1 1PM4F-1 4F 45 18K45-2

Reduce inventory levels and cost by stocking actuators and base switches separately.

Contura II, III, IV, V, X, XI, XII Base switches separately: specify V with code selections 2-8 in the ordering schemes.

Contura II, III, IV, V Actuator only: VV with code A or C for selection 9, & with selections 10-14 in the ordering schemes.

Panel Seal: VPS

Contura II, III, IV, V Actuator only: VV with code A, C, E, G or P for selection 9 & with selections 10-14 in the ordering schemes.

Contura X, XI, XII actuators with lenses separately: VV with code selections 9-14 in the ordering schemes.

Contura X & XI actuators without lenses separately:

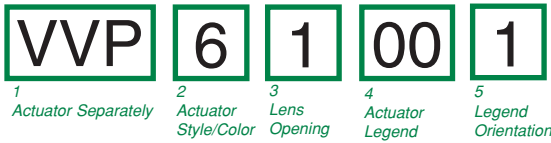

1 CONTURA X & XI ACTUATOR SEPARATELY VVP								
2 ACTUATOR STYLE & COLOR								
	Black	Gray	White	Red				
Contura X	1	2	3	4				
Contura XI	6	7	8	9				
3 LENS OPENING FOR¹								
1	One bar lens	4	Two Square lens					
2	One bar lenses	5	Square lens on top/ bar lens on bottom (Contura X only)					
3	One Square lens							
4 ACTUATOR LENS OR BODY LEGEND								
00 - No Legend this location								
11	ON	12	OFF	13	I	14	O	
	OFF		ON		O		I	
15	O	16	O	17	O	18	I	O
	F		N		N		F	
	F		F		F			
For additional legend options & codes, see page 69 of this catalog								
5 LEGEND ORIENTATION²								
0	No legend							
1	Orientation 1							
2	Orientation 2							
3	Orientation 3							
4	Orientation 4							

Contura X, XI & XII top piece of 2-piece lens separately:

VVT 1		1 TOP OF LENS SEPARATELY VVT
1	2	
Lens Separately	Color	
2 COLOR		
1	2	3
Clear	Smoke	White

Contura X, XI & XII actuator lens assembly:

actuator stem top lens

posts mount toward actuator stem bottom lens } two piece lens assembly

1 piece lens/bar lens are positioned the same as bottom lens for assembly, minus the top lens. Lenses snap in from bottom.

- NOTES**
- 1 If actuator lens opening for 2 bar or 2 square lenses, legend orientation 0, 1, or 2 must be chosen.
 - 2 Center of actuator marking not available for Contura XII.
 - 3 Legend is not available for bar style lens.
 - 4 Not recommended with neon lamps.
 - 5 Must also order top piece of 2 piece square lens separately.

Contura XII actuators without lenses separately:

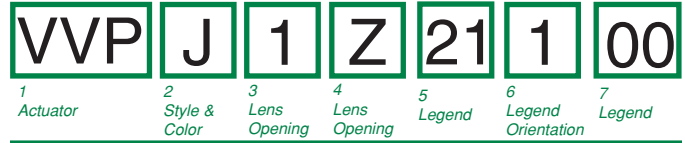

1 CONTURA XII ACTUATOR SEPARATELY VVP										
2 ACTUATOR STYLE & COLOR										
J	K	N	M							
Black	Gray	White	Red							
3,4 LENS OPENING FOR										
Z	1	2								
No lens	Bar lens	Square lens								
5, 7 LENS OR BODY LEGEND²										
00	no legend	21	OFF	22	ON	23	O	24	I	
		25	O	26	O	27	O	28	I	
			F		N		F			
For additional legend options & codes, see page 69 of this catalog.										
6 LEGEND ORIENTATION³										
0	No legend									
1	Orientation 1									
2	Orientation 2									

Contura X, XI & XII actuator lens assembly separately:

VVL 2 1 00 0								
1	2	3	4	5				
Lens Separately	Lens Style	Lens Color	Legend	Legend Orientation				
1 CONTURA X, XI & XII LENS SEPARATELY VVL								
2 LENS STYLE³								
1	2	3						
Bar lens	One Piece Square lens	Bottom of Two-Piece Square lens ⁵						
3 TRANSLUCENT LENS COLOR								
1	2	3	4	5	6			
Clear	White	Amber	Green ⁴	Red	Blue ⁴			
4 LENS OR BODY LEGEND²								
00	No legend							
21	OFF	22	ON	23	O	24	I	
	25	O	26	O	27	O	28	I
		F		N		F		
For additional legend options & codes, see page 69 of this catalog.								
5 LEGEND ORIENTATION³								
0	No legend							
1	Orientation 1							
2	Orientation 2							
3	Orientation 3							
4	Orientation 4							

Easily integrate Contura products into your system, with Contura Accessories

Contura Connectors

Q.C. SELECTION GUIDE					
COMPANY SERIES	PART NO		WIRE RANGE		ORIENTATION
	PLAIN BRASS	TIN PLATED BRASS	AWG	MM (REF)	
PACKARD 58 SERIES	02965580		12	3.0	B
	02965471	12010601	(2)16-14	(2)1.0-2.0	
	02965470		16-14	1.0-2.0	
	02965469	06288318	20-18	.5-.8	
PACKARD METRI-PACK 630 SERIES		12084590	12	3.0	A
		12052224	12	3.0	
		12015870	16-14	1.0-2.0	
		12020035	(2)22-18	(2).5-.8	
	12015832	12015869	20-18	.5-.8	
		12052222	20-22	.35-.5	
AMP 250 SERIES FASTIN-FASTON	60253-1	60253-2	16-12 (2) 16	1.3-3 (2) 1.3	B
	42100-1	42100-2	18-14	.8-2	
	60295-1	60295-2	22-18	.3-.9	

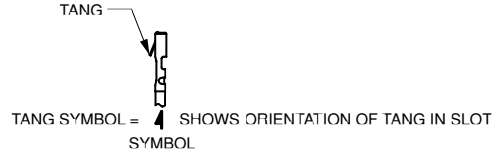

NOTE: Consult Delphi Packard and/or Amp or actual part numbers and availability.
AMP is a registered trademark of AMP Inc. Harrisburg, PA
Delphi Packard is a registered trademark of Delphi-Packard Electrical Systems Warren, Ohio

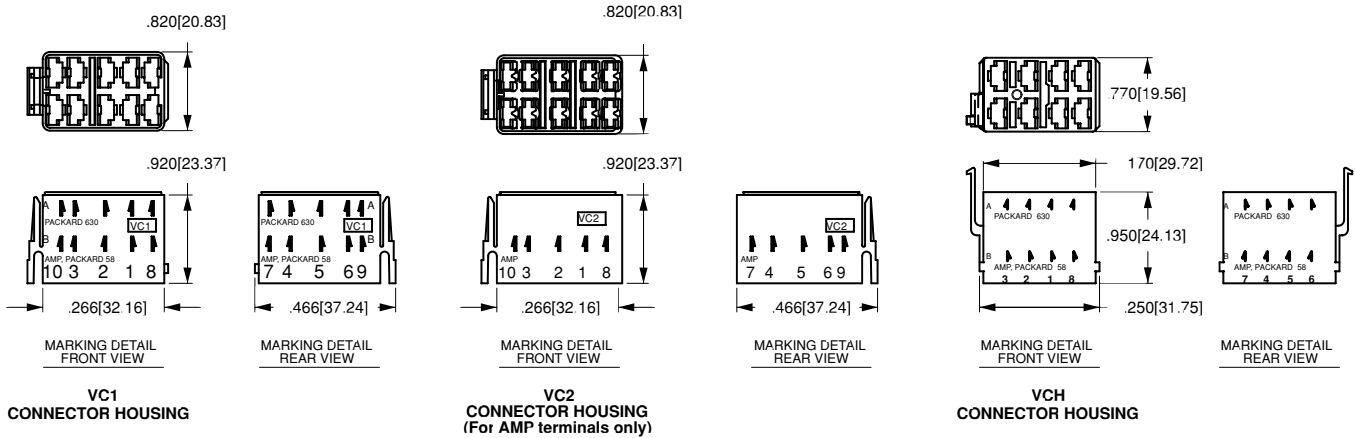

Contura X Boot

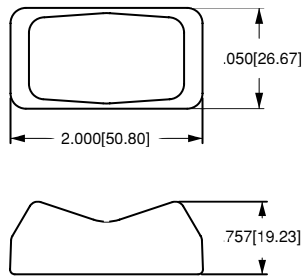

VB1-01
CONTURA X BOOT

Contura II, III, IV & V Actuator Removal Tool

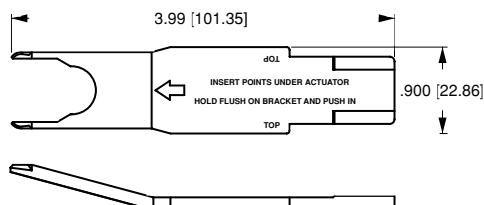

VRT
ACTUATOR REMOVAL
TOOL
(For flush bracket)



Contura Mounting Panels

Dimensional Specifications: in. [mm]

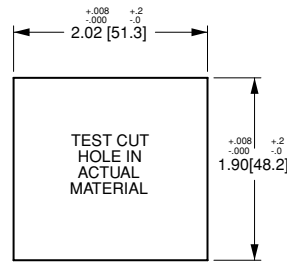
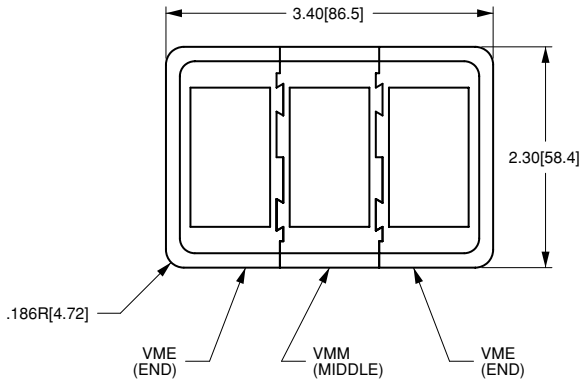

PANEL OPENING
(2) UNITS
SEE NOTE 1

PANEL THICKNESS:
TOLERANCE:

- .062[1.57]
- .093[2.36]
- .125[3.17]
- .187[4.75]
- .250[6.35]
- .375[9.52]

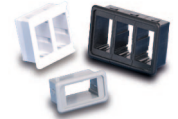

NOTES:

1. FOR ADDITIONAL UNITS, ADD 1.03 [26.2] PER UNIT.
2. FOR MORE THAN 2 V-SERIES SWITCHES, ADD MIDDLE SECTION.

Contura Hole Plug

Dimensional Specifications; in. [mm]

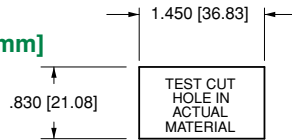

VHP
MOUNTING PANEL PLUG

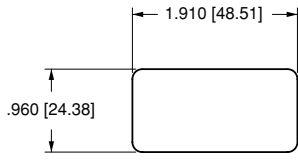

(TYP. FOR VHP, VH1 & VH2)

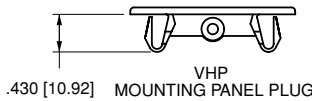

VHP
MOUNTING PANEL PLUG

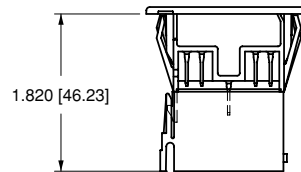

VH1
STANDARD HOLE PLUG
(No wing serrations)
(With VC1 connector attached)

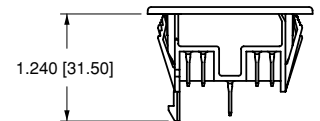

VH2
STANDARD HOLE PLUG
(With wing serrations)

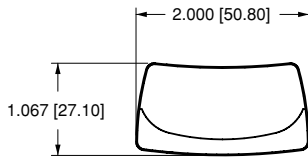

(TYP. FOR VH3 & VH4)

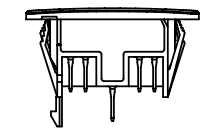

VH3
CONTURA IV HOLE PLUG
(No wing serrations)

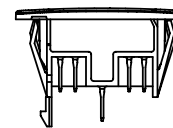

VH4
CONTURA IV HOLE PLUG
(With wing serrations)



DETAIL VIEW
VH1, VH3 & VH5
HOLE PLUGS
(No wing serrations
for ease of removal)

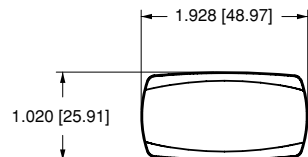

(TYP. FOR VH5 & VH6)

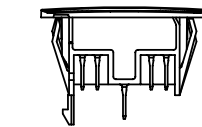

VH5
CONTURA V HOLE PLUG
(No wing serrations)

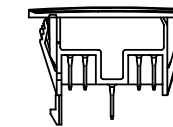

VH6
CONTURA V HOLE PLUG
(With wing serrations)

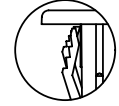

















DETAIL VIEW
VH2, VH4 & VH6
HOLE PLUGS
(With wing serrations)

















Additional V-Series Ratings

- | | |
|---|---|
| <p>1 .4VA @ 28VDC Resistive</p> <p>4 10A 250VAC 1/2 HP, 15A 125 VAC 1/2 H, No Agency Listings</p> <p>5 10A 250VAC 1/2 HP, 15A 125 VAC 1/2 HP, UL Recognized, CSA Certified</p> <p>6* 15A 125VAC 1/2 HP, 12(2)A 125 VAC μ T85</p> <p>7* 15A 125VAC 1/2 HP, 12(6)A 125 VAC T85</p> <p>8* 10A 250VAC, 15A 125VAC, 1/2 HP 125-250VAC, 12(2)A 250 VAC μ T85</p> <p>9* 10A 250VAC, 15A 125VAC, 1/2 HP 125-250VAC, 12(6)A 250 VAC T85</p> <p>B 15A 24V</p> <p>C 20A 18V</p> <p>D 20A 12V</p> <p>E 20A 14V, 10A 14VT (circuits 1, 4, A, & D only)</p> <p>F 10A 14V, 6A, 14VT (circuit G only)</p> <p>G 20A 6V</p> <p>H 20A 3V</p> | <p>L 15A 125 VAC, 10A 250VAC, 1/2 HP 125-250 VAC; 6A 125 VAC L</p> <p>M .4VA/20A 12V (combi-contact)
(combination gold/silver contacts for borderline dry circuit applications)</p> <p>N .4VA/15A 24V (combi-contact)
(combination gold/silver contacts for borderline dry circuit applications)</p> |
|---|---|

NOTES

Consult factory to determine availability for individual circuits.
 * Ratings 6 - 9 are UL, CSA, VDE, DEMKO, SEMKO, NEMKO, FIMKO & BEAB certified, require terminations A or B for double pole circuits, & are not available with illumination circuits 4, 8, D, J, N, & T or with wire lead or solder lug terminations. Circuits 1, 4, A & D are not available with rating 6 & 8. Rating 7 & 9 only available with circuits 1, 4, A & D. Circuits 2, 3, 5, 7, 8, K, L are 1/2 HP 250VAC only with rating 8. Ratings 6 & 7 must specify lamp code 1 (125VAC neon). Ratings 8 & 9 must specify lamp code 2 (250VAC neon). Rating L available with circuits 1, 4, A & D only.

LEGEND		LEGEND CODE		
SYMBOL	NAME <small>(SYMBOL MEANING)</small>	BODY	LENS	
			NEGATIVE ¹	POSITIVE
	RUNNING LIGHTS (UNDER POWER)	AA	NA	MA
	LIGHT	AB	NB	MB
	MASTER LIGHT SWITCH	AC	NC	MC
	HORN	AD	ND	MD
	PROPULSION SYSTEM TRIM TRIMMING OPERATION	AE	NE	ME
	VENTILATION FAN OR BLOWER	AF	NF	MF
	WINDSHIELD WASHER	AG	NG	MG
	WINDSHIELD WIPER	AH	NH	MH
	BILGE PUMP	AJ	NJ	MJ
	BILGE BLOWER	AK	NK	MK
	POTABLE WATER PRESSURE	AL	NL	ML
	ENGINE START	AM	ED	MM
	ENGINE STOP	AN	EE	MN
	DRIVE TILT TILT OPERATION	30		31
	EMERGENCY START	32		33
	UP/DOWN LIFT	34		
	TRIM TAB TRIMMING OPERATION	35		36

LEGEND		LEGEND CODE		
SYMBOL	NAME <small>(SYMBOL MEANING)</small>	BODY	LENS	
			NEGATIVE ¹	POSITIVE
	ANCHOR LIGHT	37		38
	ANCHOR	39		40
	WATER FLUSHING TAP FOR OUTBOARDS	41		42
	HIGH BEAM	43	44	45
	LOW / DIPPED BEAM	46	47	48
	SIDE MARKER LIGHT	DG	49	DF
	INTERIOR LIGHT	50	51	52
	WORK LIGHT	53	54	55
	WORK LAMP	56	57	58
	LOADING FLOOR LAMP	CW	59	CY
	ON -WIPER-INT DELAY	60		
	ROTARY BEACON	61	62	63
	LAMP TEST	DK	64	DL
	WINDSHIELD WIPER/WASHER	65	66	67
	HAZARD WARNING	68	69	70
	WARM AIR BLOWER	71	72	73
	HORN REAR	AX	74	Y4

NOTE

¹ Negative lens not available on L or LD-Series.
Additional Standard Markings available. Consult factory.