

Distinctive Characteristics

High performance and high quality at a low price.

Molded cover and case of high insulating material withstand 12 kilovolts of electrostatic discharge (ESD), providing antistatic feature.

Cover and case UL 94V-0 flammability rated.

Epoxy sealed terminals to lock out flux, dust, and other contaminants.

Suited for a wide variety of applications including telecommunications, electronic controls, audio devices, and household appliances.

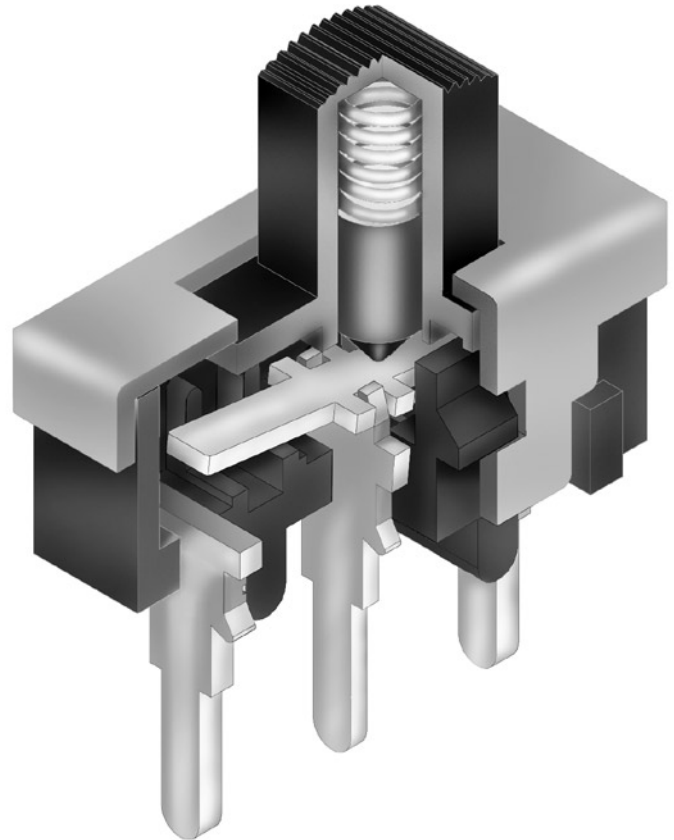

Actual Size

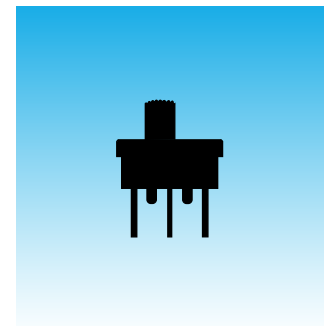

General Specifications

Electrical Capacity (Resistive Load)

Power Level: 3A @ 125V AC or 2A @ 250V AC

Other Ratings

Contact Resistance: 10 milliohms maximum
Insulation Resistance: 1,000 megohms minimum @ 500V DC
Dielectric Strength: 1,000V AC minimum between contacts for 1 minute minimum;
 1,500V AC minimum between contacts & case for 1 minute minimum
Mechanical Life: 50,000 operations minimum
Electrical Life: 20,000 operations minimum
Static Capability: Withstands 12 kilovolts ESD
Contact Timing: Nonshorting (break-before-make)
Total Travel: .087" (2.2mm)

Materials & Finishes

Actuator: Glass fiber reinforced polyamide
Cover & Case: Glass fiber reinforced polyamide (UL94V-0)
Movable Contacts: Copper with silver plating
Stationary Contacts: Silver capped copper with silver plating
Terminals: Copper with silver plating

Environmental Data

Operating Temp Range: -30°C through +85°C (-22°F through +185°F)
Humidity: 90 ~ 95% humidity for 240 hours @ 40°C (104°F)
Vibration: 10 ~ 55Hz with peak-to-peak amplitude of 1.5mm traversing the frequency range & returning in 1 minute; 3 right angled directions for 2 hours
Shock: 50G (490m/s²) acceleration (tested in 6 right angled directions, with 5 shocks in each direction)

Installation

Soldering Time & Temp: Wave Soldering: See Profile A in Supplement section.
 Manual Soldering: See Profile B in Supplement section.
Cleaning: These devices are not process sealed. Hand clean locally using alcohol based solution.

Standards & Certifications

Flammability Standard: UL94V-0 cover & case

TYPICAL SWITCH ORDERING EXAMPLE

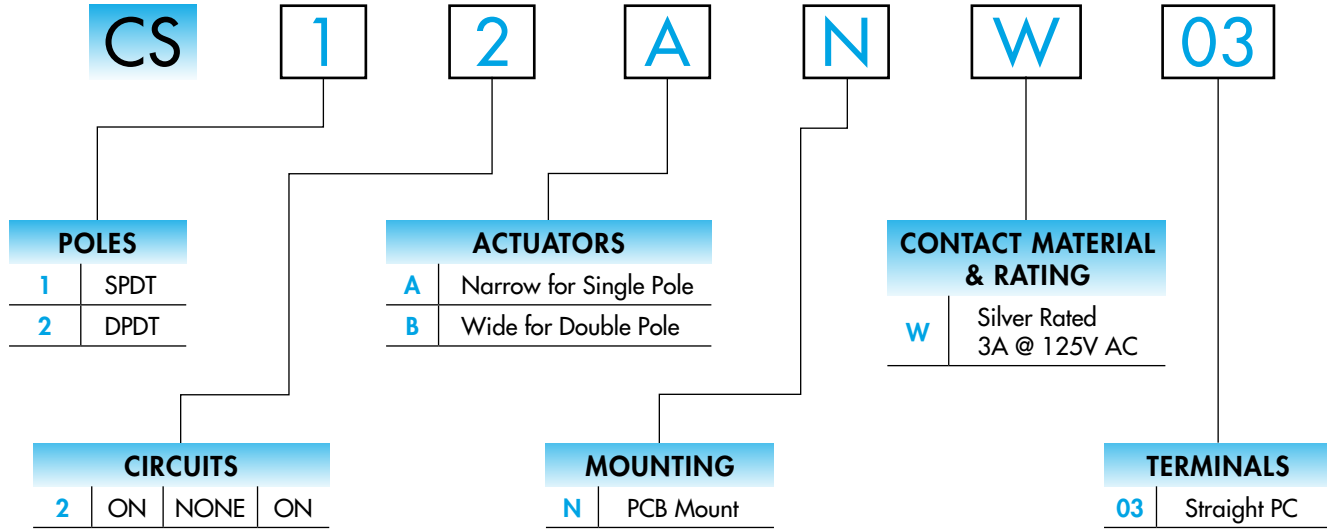

DESCRIPTION FOR TYPICAL ORDERING EXAMPLE

CS12ANW03

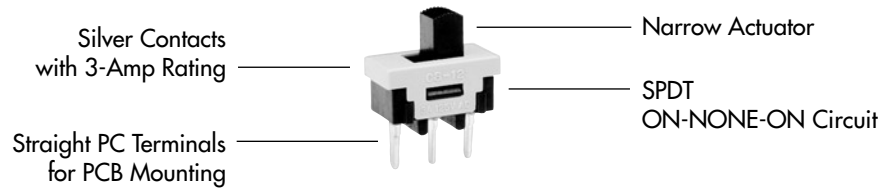

POLES & CIRCUITS

Pole	Model	Slide Position			Connected Terminals			Throw & Schematics
		Left	Center	Right	Left	Center	Right	
SP	CS12	ON	NONE	ON	2-1	OPEN	2-3	SPDT Note: Terminal numbers are not actually on switch.
DP	CS22	ON	NONE	ON	2-1 5-4	OPEN	2-3 5-6	DPDT

MOUNTING

Panel Cutouts

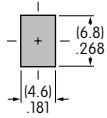

Single Pole

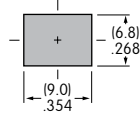

Double Pole

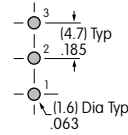

Single Pole

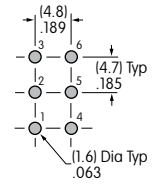

Double Pole

TYPICAL SWITCH DIMENSIONS

Single Pole

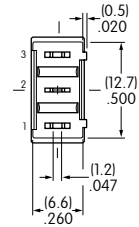
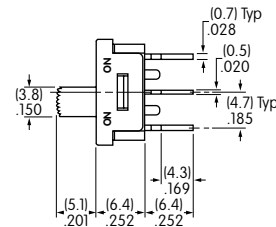
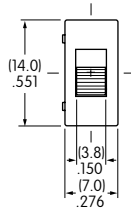

CS12ANW03

Actuator shown in LEFT position

Double Pole

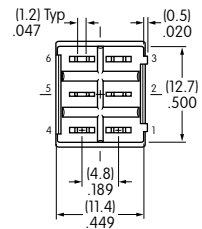
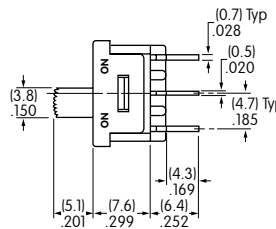
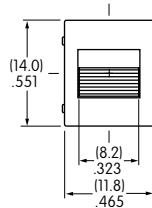

CS22BNW03

Actuator shown in LEFT position