



SERIES EG SWITCHES

SLIDE SWITCHES

TACT. SWITCHES

NAVIGATION SWITCHES

PUSHBUTTON SWITCHES

TOGGLE SWITCHES

ROCKER SWITCHES

SLIDE SWITCHES

SNAP-ACTION SWITCHES

DIP SWITCHES

KEYLOCK SWITCHES

ROTARY SWITCHES

DETECTOR SWITCHES

CAP. OPTIONS



SPECIFICATIONS

Contact Resistance:	Less than 20 milliohms
Insulation Resistance:	500VDC – 100 milliohms
Dielectric Strength:	500V AC for 1 minute between any terminal and frame
Operating Temperature:	-20°C to +70°C (-4°F to +158°F)

FEATURES & BENEFITS

- ▶ Variety of package styles & sizes
- ▶ Up to 6 poles
- ▶ Variety of functions
- ▶ Positive detent
- ▶ SMT options

APPLICATIONS/MARKETS

- ▶ Computer servers/peripherals
- ▶ Consumer electronics
- ▶ Instrumentation
- ▶ Test & measurement

MATERIALS

Contact: Silver plated copper alloy

▶ ▶ ▶ Example Ordering Number
EG-1201A

HOW TO ORDER

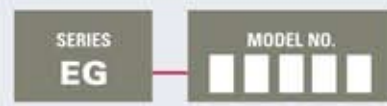

Specifications subject to change without notice.

EG 1201

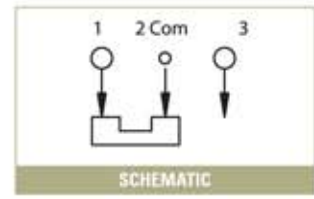
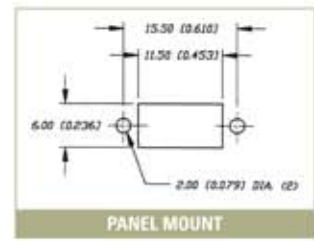
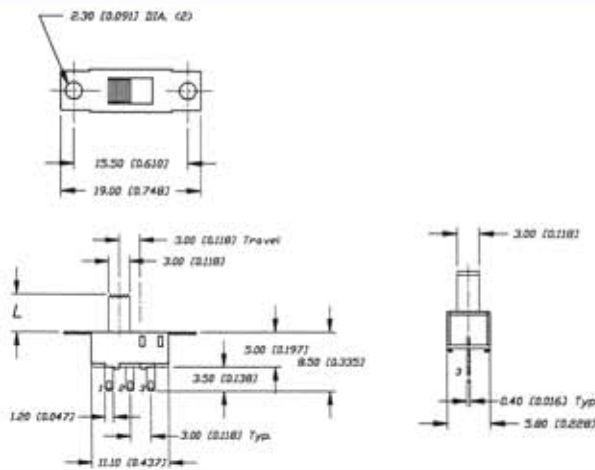

Model No.	L
EG1201	4
EG1201A	5.5

EG 1205

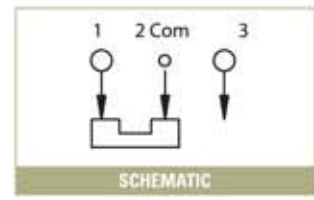
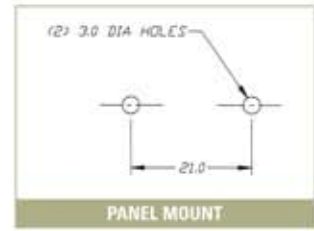
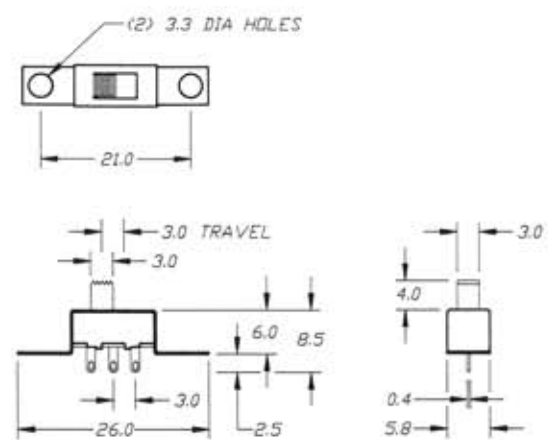

Model No.	L
EG1205	4
EG1205A	5.5



EG 1206



Model No.	L
EG1206	3
EG1206A	6

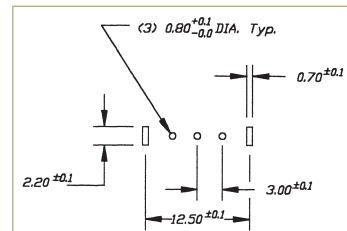
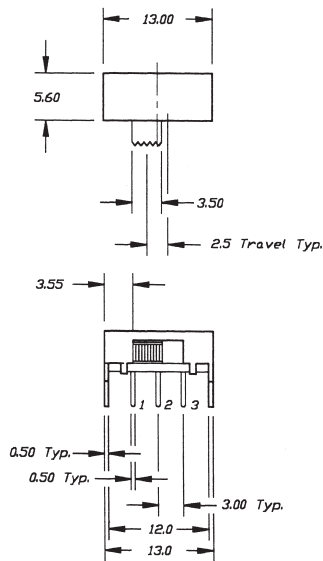

P.C. MOUNTING

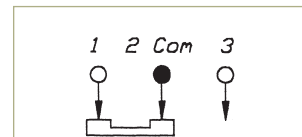

SCHEMATIC

EG 1213

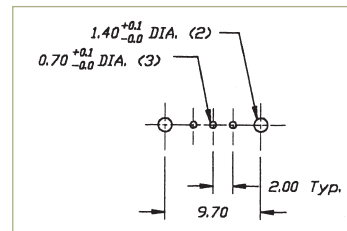
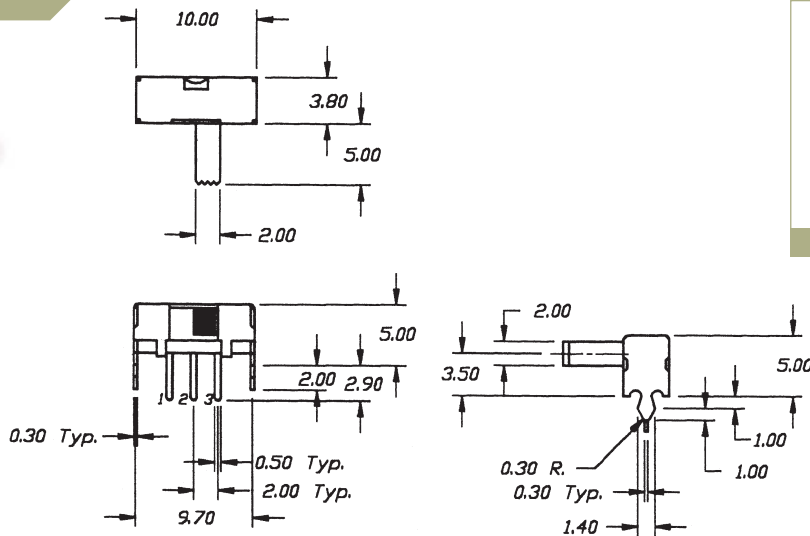
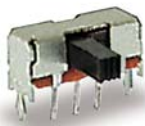

P.C. MOUNTING

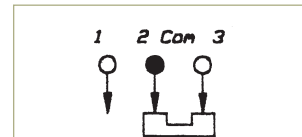

SCHEMATIC

EG 1218

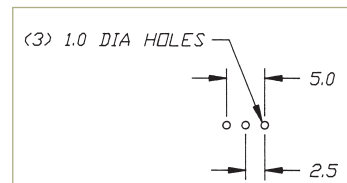
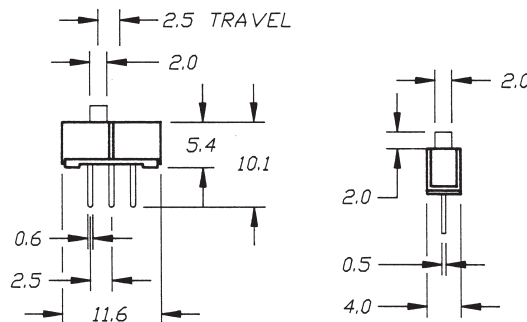

P.C. MOUNTING

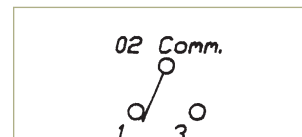

SCHEMATIC

TACT SWITCHES

NAVIGATION SWITCHES

PUSHBUTTON SWITCHES

TOGGLE SWITCHES

ROCKER SWITCHES

SLIDE SWITCHES

SNAP-ACTION SWITCHES

DIP SWITCHES

KEYLOCK SWITCHES

ROTARY SWITCHES

DETECTOR SWITCHES

CAP OPTIONS



SERIES EG SWITCHES

SLIDE SWITCHES

TACT SWITCHES

NAVIGATION SWITCHES

PUSHBUTTON SWITCHES

TOGGLE SWITCHES

ROCKER SWITCHES

SLIDE SWITCHES

SNAP-ACTION SWITCHES

DIP SWITCHES

KEYLOCK SWITCHES

ROTARY SWITCHES

DETECTOR SWITCHES

CAP OPTIONS

EG 1224

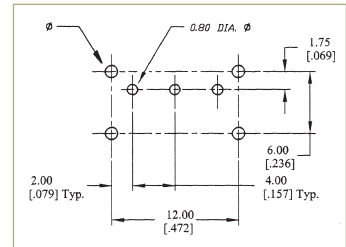
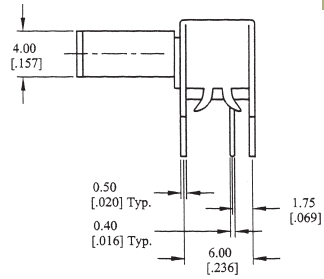
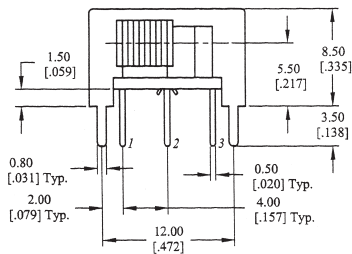
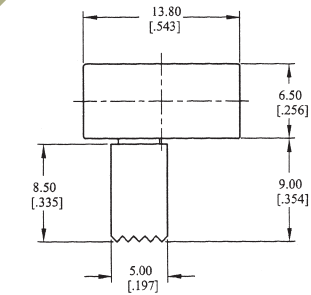

P.C. MOUNTING

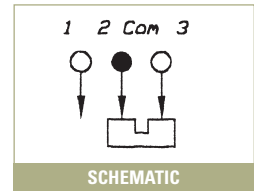

SCHEMATIC

EG 1247

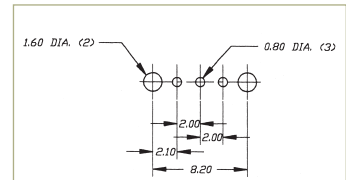
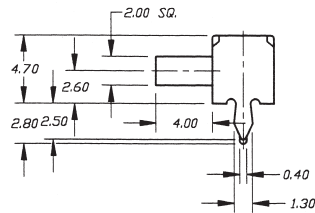
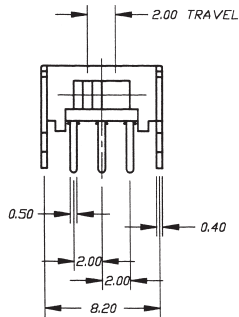
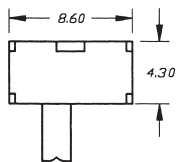

P.C. MOUNTING

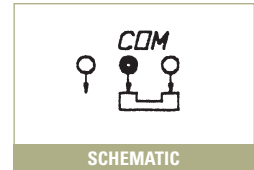

SCHEMATIC

EG 1248

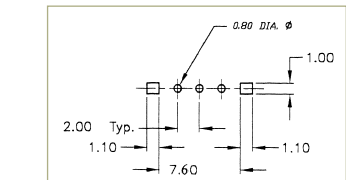
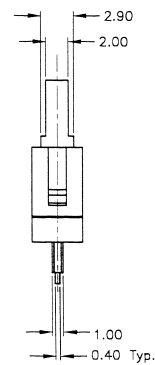
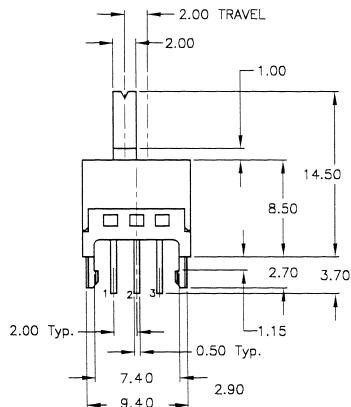
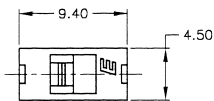

P.C. MOUNTING

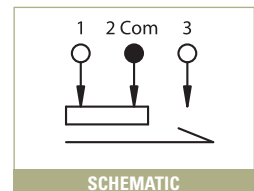

SCHEMATIC



EG 1249

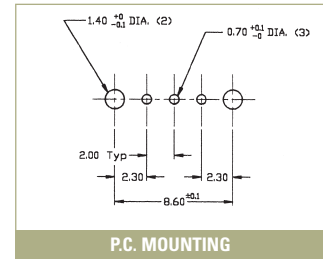
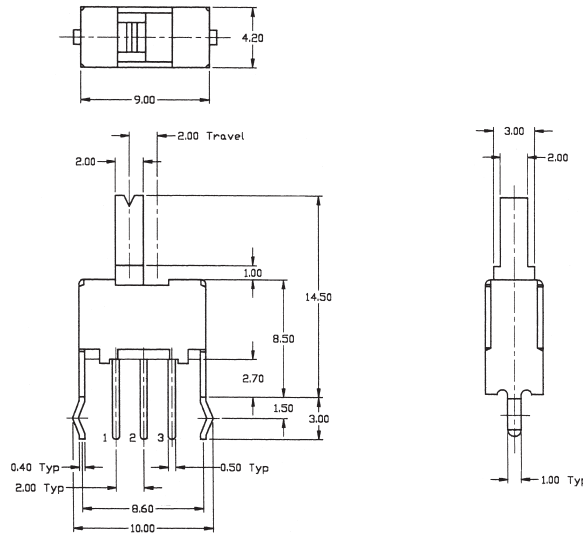

P.C. MOUNTING

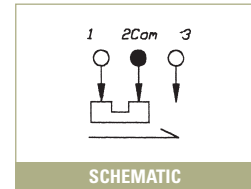

SCHEMATIC

EG 1253



Momentary Only

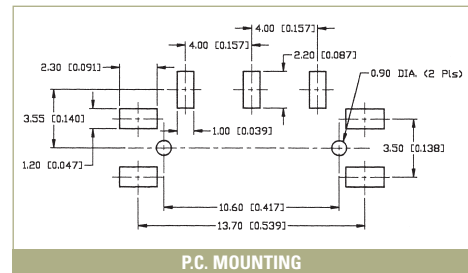
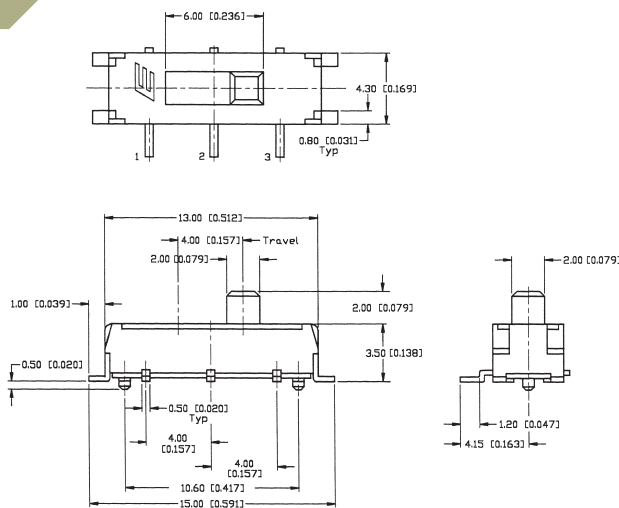

P.C. MOUNTING

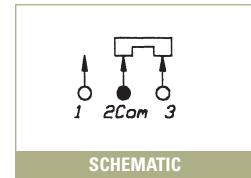

SCHEMATIC

EG 1260

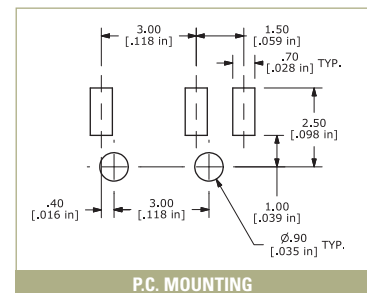
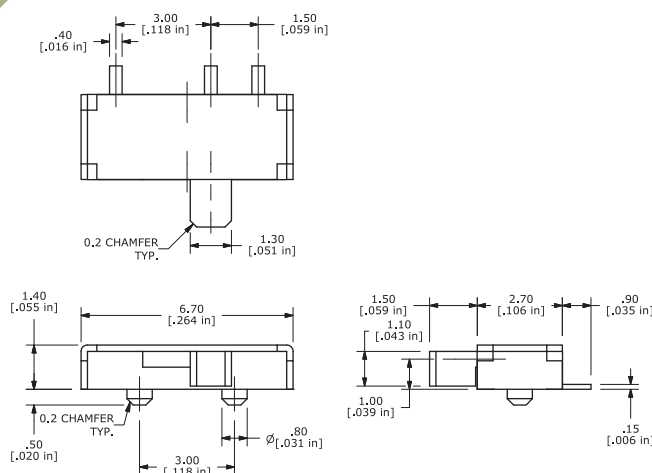

P.C. MOUNTING

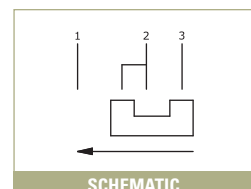

SCHEMATIC

TACT SWITCHES

NAVIGATION SWITCHES

PUSHBUTTON SWITCHES

TOGGLE SWITCHES

ROCKER SWITCHES

SLIDE SWITCHES

SNAP-ACTION SWITCHES

DIP SWITCHES

KEYLOCK SWITCHES

ROTARY SWITCHES

DETECTOR SWITCHES

CAP OPTIONS

SERIES EG SWITCHES

SLIDE SWITCHES

TACT SWITCHES

NAVIGATION SWITCHES

PUSHBUTTON SWITCHES

TOGGLE SWITCHES

ROCKER SWITCHES

SLIDE SWITCHES

SNAP-ACTION SWITCHES

DIP SWITCHES

KEYLOCK SWITCHES

ROTARY SWITCHES

DETECTOR SWITCHES

CAP OPTIONS

EG 1270

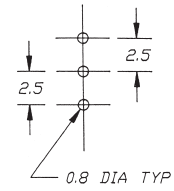
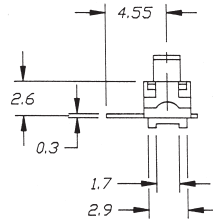
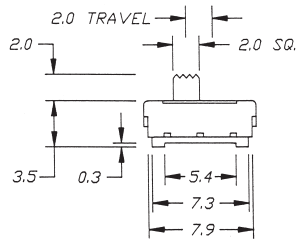
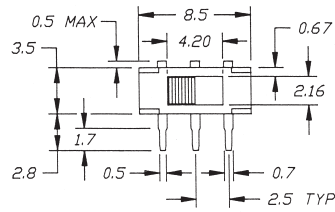

P.C. MOUNTING

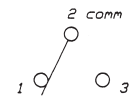

SCHEMATIC

EG 1271

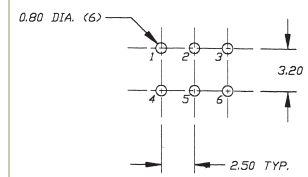
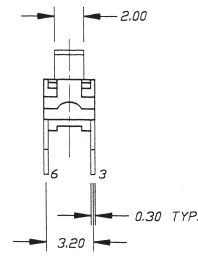
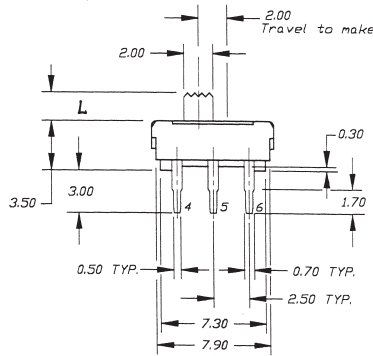
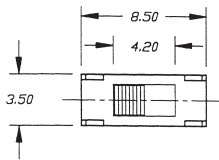

P.C. MOUNTING

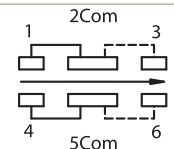

SCHEMATIC

Model No.	L
EG1271	2
EG1271A	4.4

EG 1302

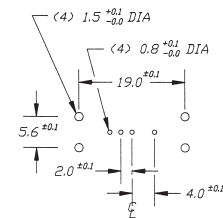
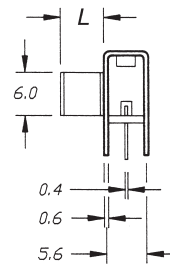
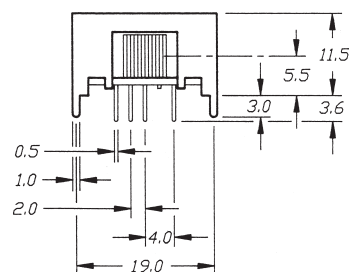
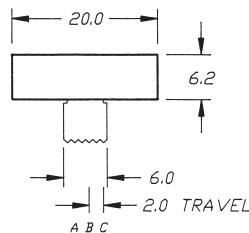

P.C. MOUNTING

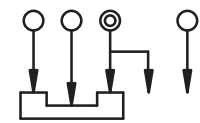

SCHEMATIC

Model No.	L
EG1302	6
EG1302A	9



EG 1307

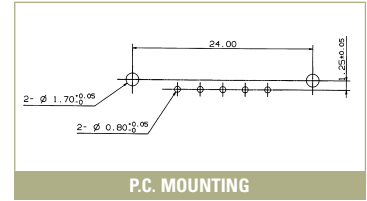
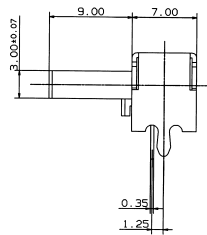
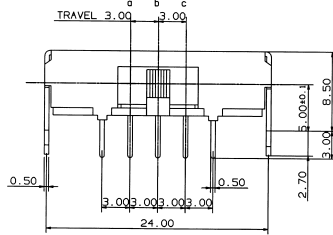
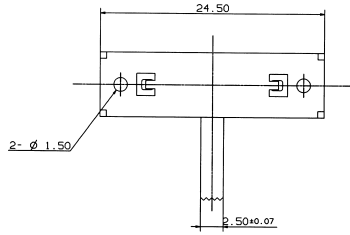

P.C. MOUNTING

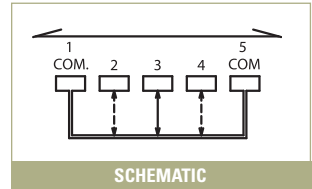

SCHEMATIC

EG 1313

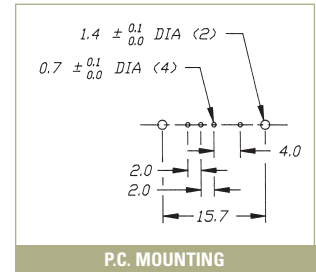
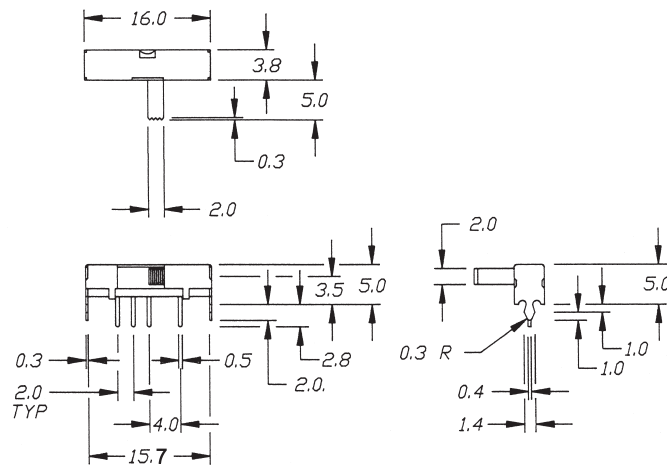

P.C. MOUNTING

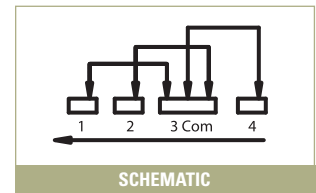

SCHEMATIC

EG 2201



Model No.	L
EG2201	3
EG2201A	6
EG2201B	9
EG2201C	12
EG2201D	4.5

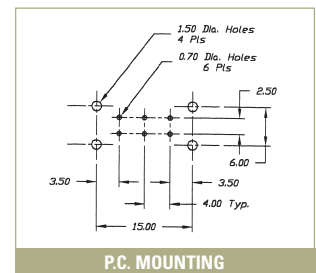
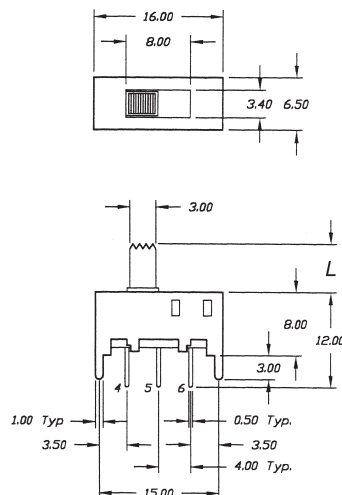

P.C. MOUNTING

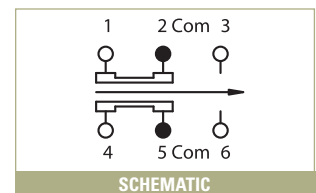

SCHEMATIC

TACT SWITCHES

NAVIGATION SWITCHES

PUSHBUTTON SWITCHES

TOGGLE SWITCHES

ROCKER SWITCHES

SLIDE SWITCHES

SNAP-ACTION SWITCHES

DIP SWITCHES

KEYLOCK SWITCHES

ROTARY SWITCHES

DETECTOR SWITCHES

CAP OPTIONS



SERIES EG SWITCHES

SLIDE SWITCHES

TACT SWITCHES

NAVIGATION SWITCHES

PUSHBUTTON SWITCHES

TOGGLE SWITCHES

ROCKER SWITCHES

SLIDE SWITCHES

SNAP-ACTION SWITCHES

DIP SWITCHES

KEYLOCK SWITCHES

ROTARY SWITCHES

DETECTOR SWITCHES

CAP OPTIONS

EG 2202



Model No.	L
EG2202	5
EG2202A	7.5
EG2202B	9

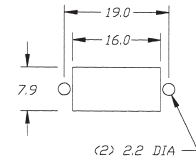
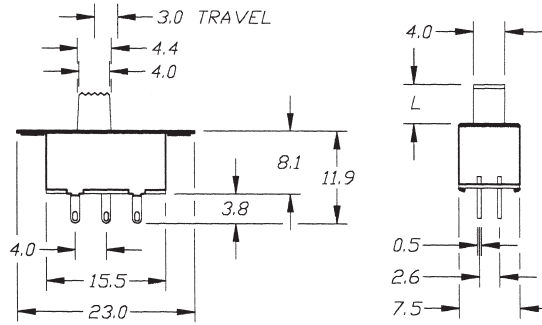
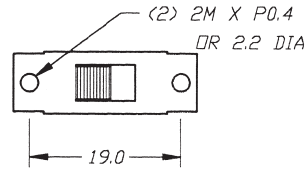

P.C. MOUNTING

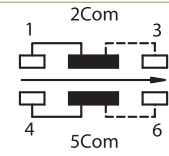

SCHEMATIC

EG 2205



Model No.	L
EG2205	4
EG2205A	2

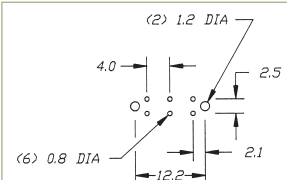
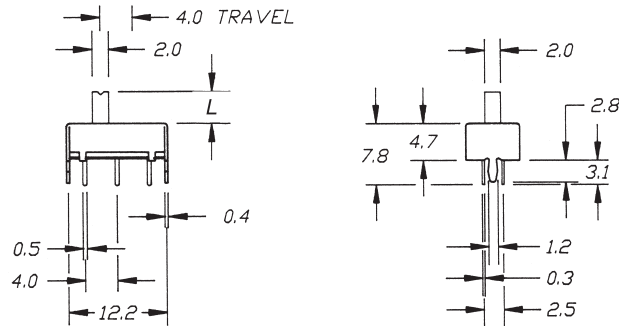
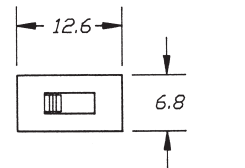

P.C. MOUNTING

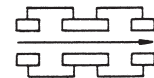

SCHEMATIC

EG 2207

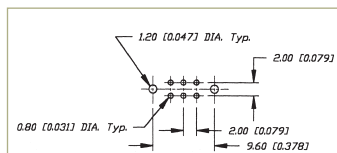
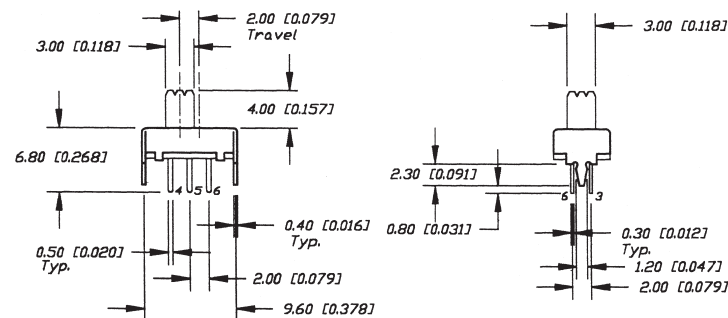
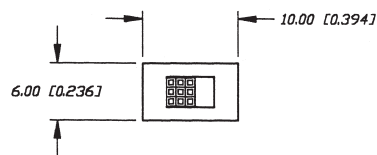

P.C. MOUNTING

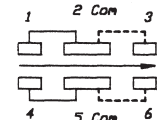

SCHEMATIC



EG 2208



Model No.	L
EG2208	4
EG2208A	6

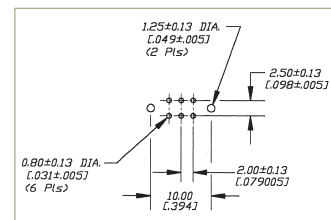
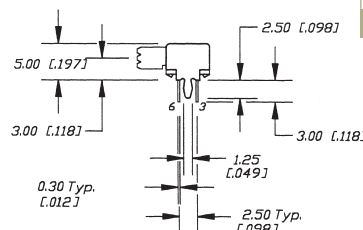
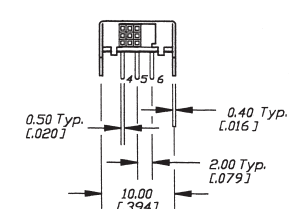
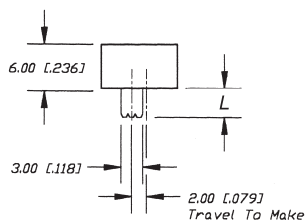

P.C. MOUNTING

SCHEMATIC

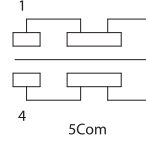

EG 2209



Model No.	L
EG2209	2
EG2209A	4

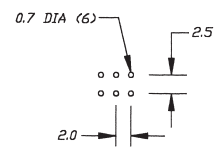
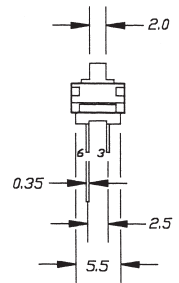
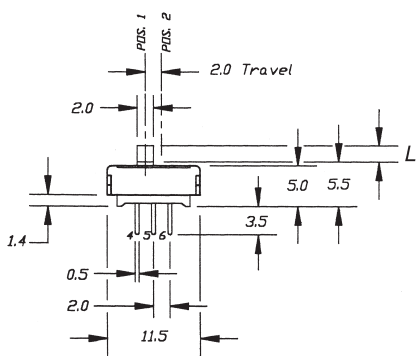
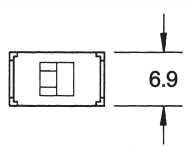

P.C. MOUNTING

SCHEMATIC



EG 2210

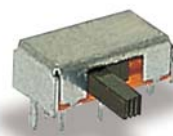

Model No.	L
EG2210	6
EG2210A	4
EG2210D	2

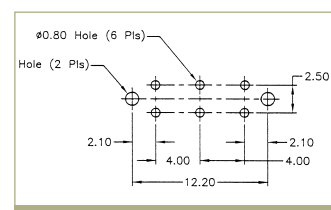
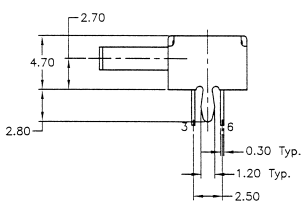
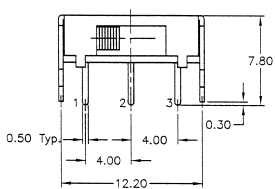
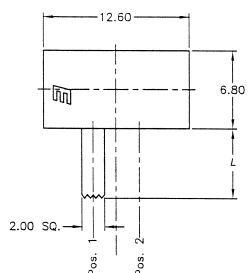

P.C. MOUNTING

SCHEMATIC

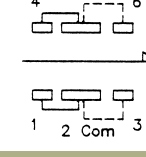

TACT SWITCHES

NAVIGATION SWITCHES

PUSHBUTTON SWITCHES

TOGGLE SWITCHES

ROCKER SWITCHES

SLIDE SWITCHES

SNAP-ACTION SWITCHES

DIP SWITCHES

KEYLOCK SWITCHES

ROTARY SWITCHES

DETECTOR SWITCHES

CAP OPTIONS



SERIES EG SWITCHES

SLIDE SWITCHES

TACT SWITCHES

NAVIGATION SWITCHES

PUSHBUTTON SWITCHES

TOGGLE SWITCHES

ROCKER SWITCHES

SLIDE SWITCHES

SNAP-ACTION SWITCHES

DIP SWITCHES

KEYLOCK SWITCHES

ROTARY SWITCHES

DETECTOR SWITCHES

CAP OPTIONS

EG 2211



Model No.	L
EG2211	4
EG2211A	2

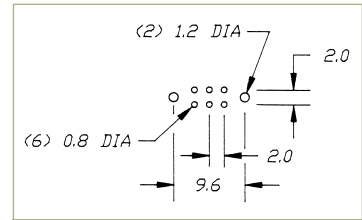
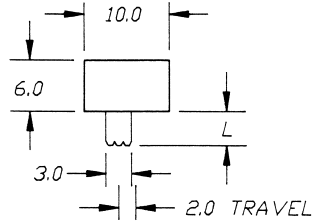

P.C. MOUNTING

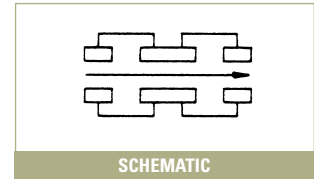
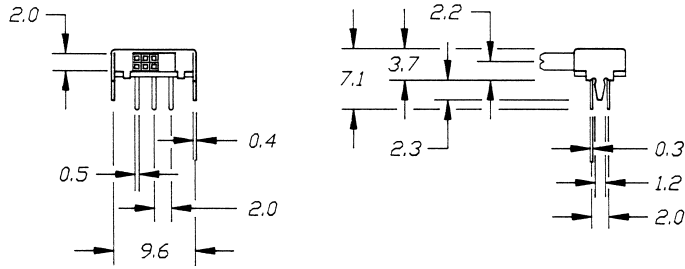

SCHEMATIC

EG 2214

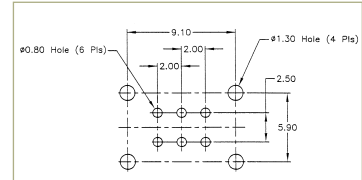
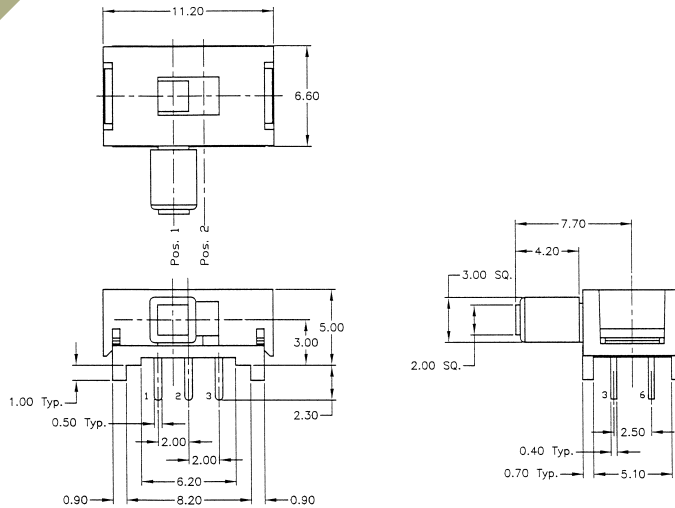

P.C. MOUNTING

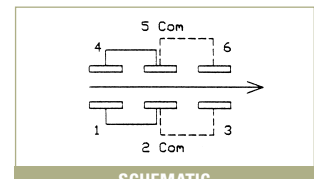

SCHEMATIC

EG 2215



Model No.	L
EG2215	3.5
EG2215A	6

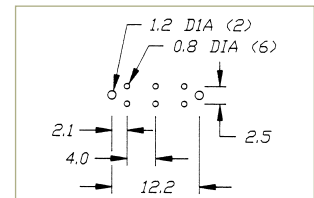
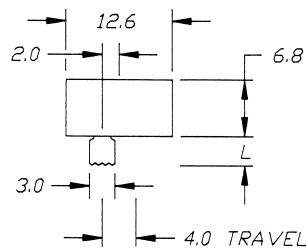

P.C. MOUNTING

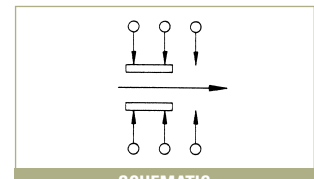
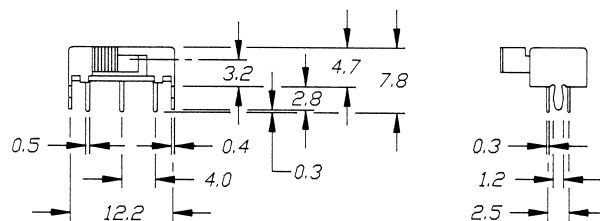

SCHEMATIC



EG 2219

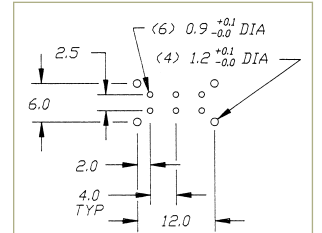
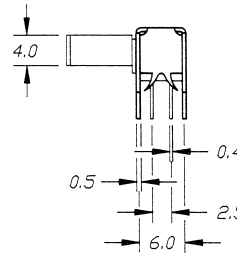
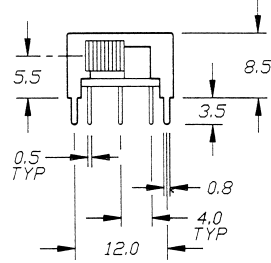
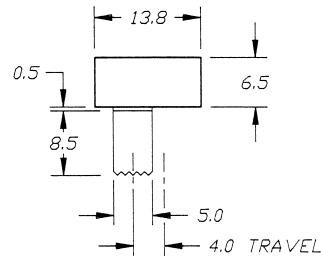

P.C. MOUNTING

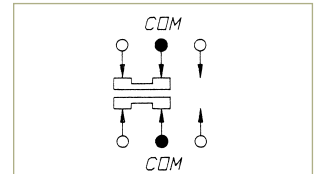

SCHEMATIC

EG 2301



Model No.	L
EG2301	3
EG2301A	6
EG2301B	9
EG2301C	12

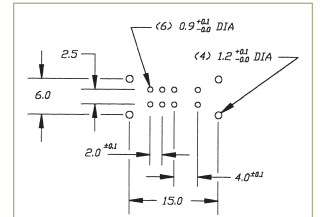
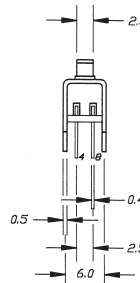
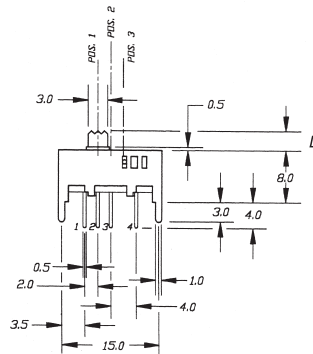
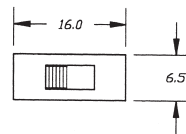

P.C. MOUNTING

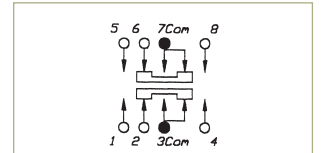

SCHEMATIC

EG 2303

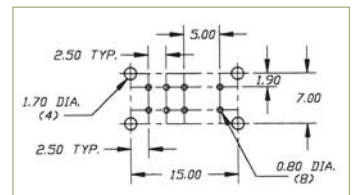
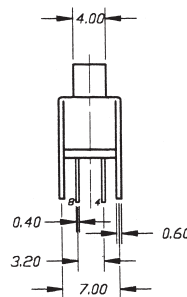
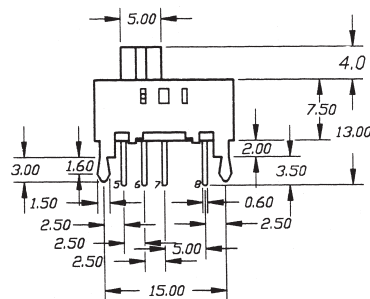
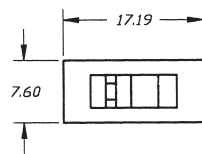

P.C. MOUNTING

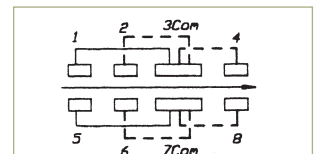

SCHEMATIC



SERIES EG SWITCHES

SLIDE SWITCHES

TACT SWITCHES

NAVIGATION SWITCHES

PUSHBUTTON SWITCHES

TOGGLE SWITCHES

ROCKER SWITCHES

SLIDE SWITCHES

SNAP-ACTION SWITCHES

DIP SWITCHES

KEYLOCK SWITCHES

ROTARY SWITCHES

DETECTOR SWITCHES

CAP OPTIONS

EG 2305

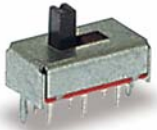

Model No.	L
EG2305	4
EG2305A	2

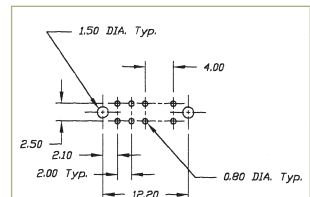
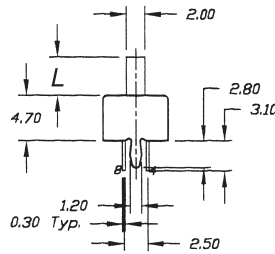
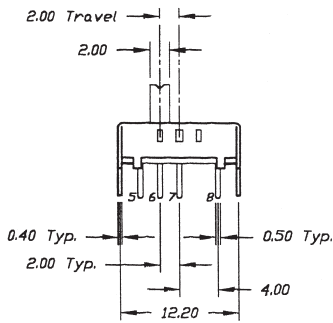
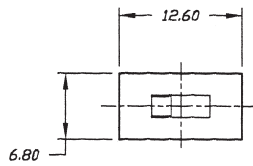

P.C. MOUNTING

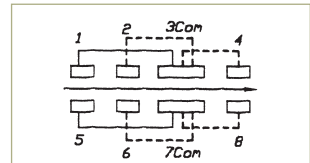

SCHEMATIC

EG 2308



Model No.	L
EG2308	4
EG2308A	6

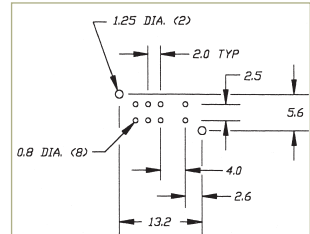
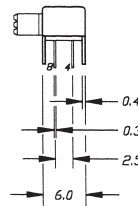
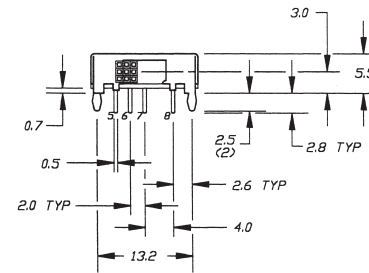
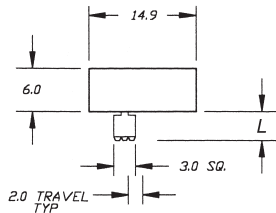

P.C. MOUNTING

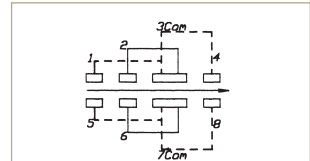

SCHEMATIC

EG 2310



Model No.	L
EG2310	6
EG2310A	4

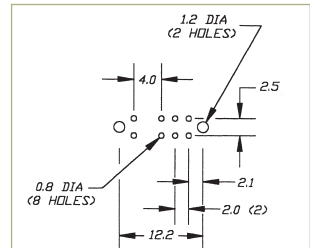
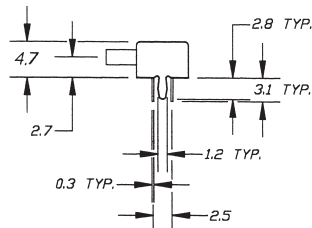
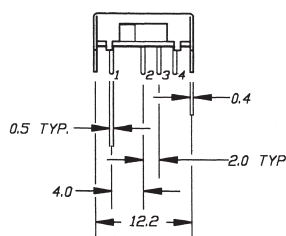
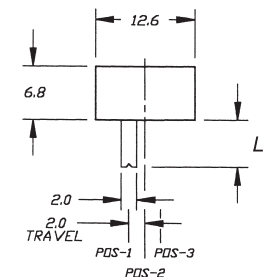

P.C. MOUNTING

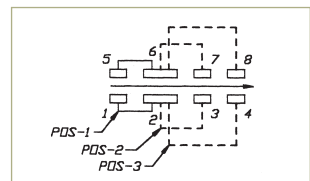

SCHEMATIC



EG 2315



Model No.	L
EG2315	3.5
EG2315A	6

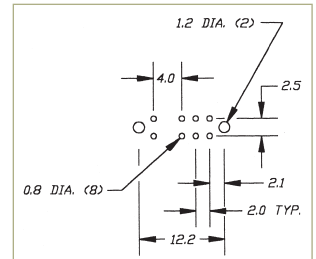
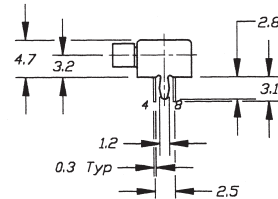
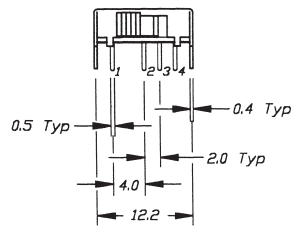
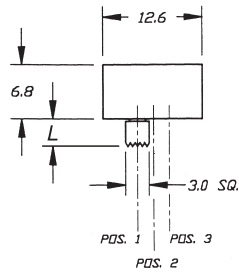

P.C. MOUNTING

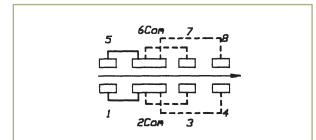

SCHEMATIC

EG 2319

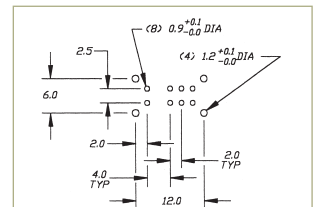
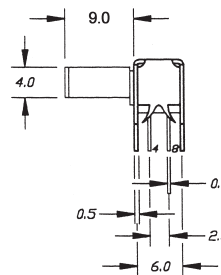
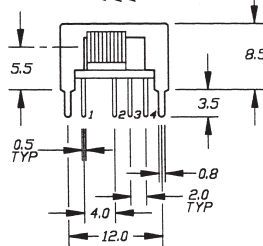
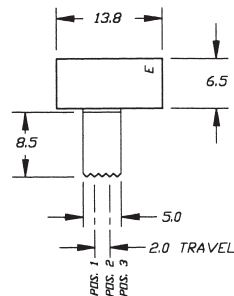

P.C. MOUNTING

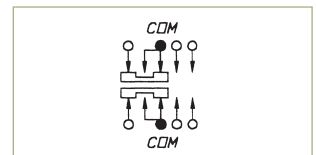

SCHEMATIC

EG 2322

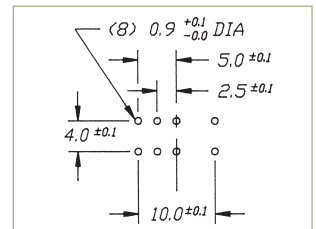
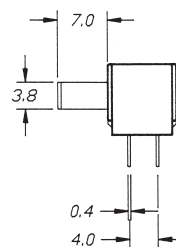
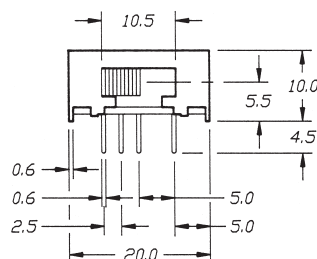
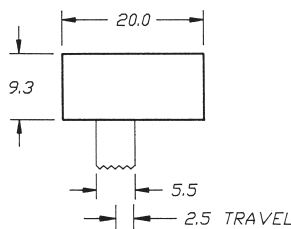

P.C. MOUNTING

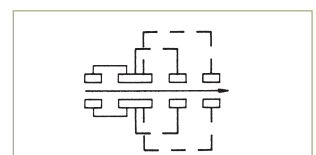

SCHEMATIC

TACT SWITCHES
 NAVIGATION SWITCHES
 PUSHBUTTON SWITCHES
 TOGGLE SWITCHES
 ROCKER SWITCHES
 SLIDE SWITCHES
 SNAP-ACTION SWITCHES
 DIP SWITCHES
 KEYLOCK SWITCHES
 ROTARY SWITCHES
 DETECTOR SWITCHES
 CAP OPTIONS



SERIES EG SWITCHES

SLIDE SWITCHES

TACT SWITCHES

NAVIGATION SWITCHES

PUSHBUTTON SWITCHES

TOGGLE SWITCHES

ROCKER SWITCHES

SLIDE SWITCHES

SNAP-ACTION SWITCHES

DIP SWITCHES

KEYLOCK SWITCHES

ROTARY SWITCHES

DETECTOR SWITCHES

CAP OPTIONS

EG 2323

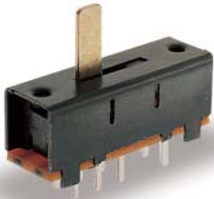

Model No.	Mtg. Hole
EG2323	None
EG2323A	M2.6 x P0.45

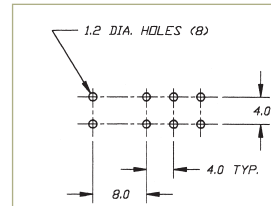
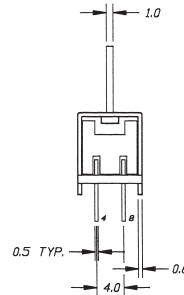
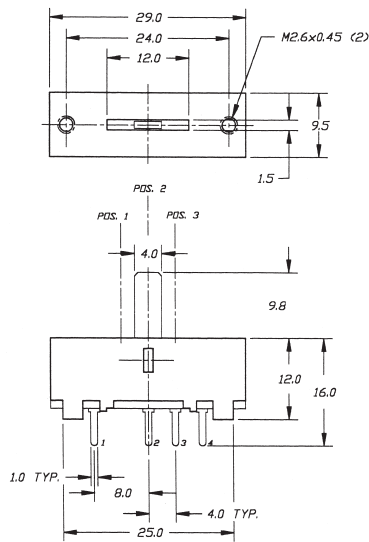

P.C. MOUNTING

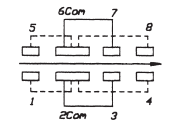

SCHEMATIC

EG 2324

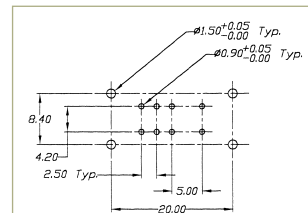
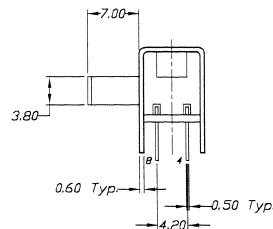
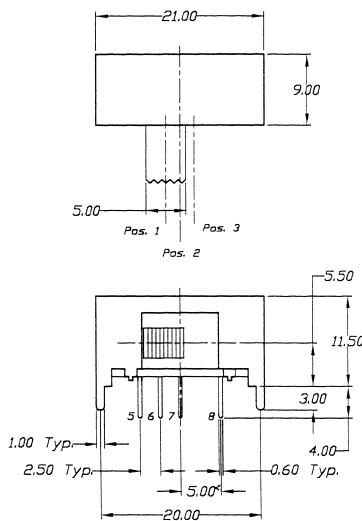
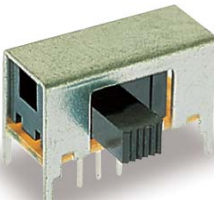

P.C. MOUNTING

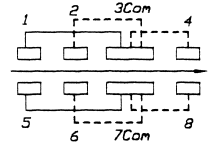

SCHEMATIC

EG 2325



Model No.	L
EG2325	2
EG2325A	6

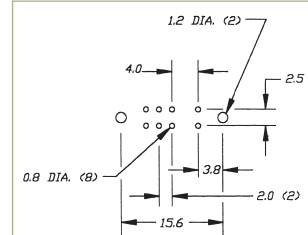
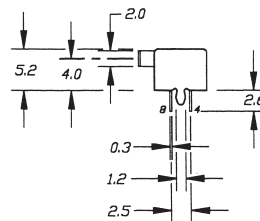
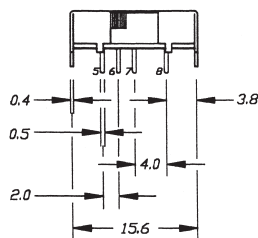
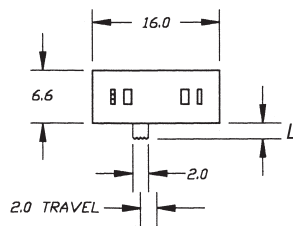

P.C. MOUNTING

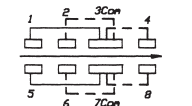

SCHEMATIC



EG 2601

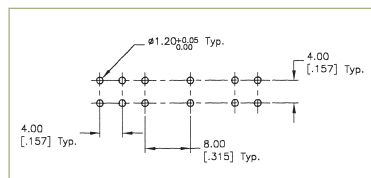
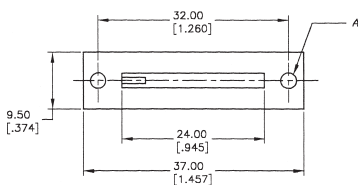
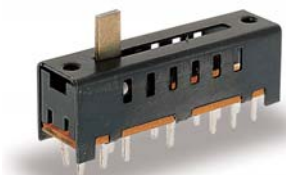

P.C. MOUNTING

Model No.	L	"A"
EG2601	9.8	None
EG2601A	9.8	M2.6 x P0.45
EG2601B	6.5	M2.6 x P0.45
EG2601C	6.5	None

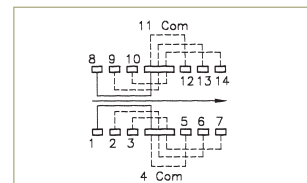
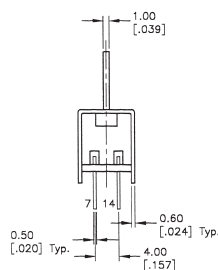
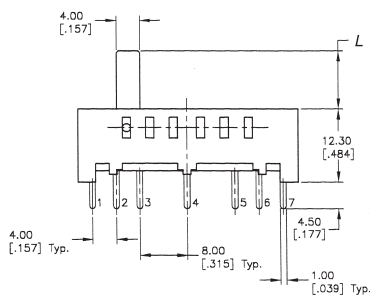

SCHEMATIC

EG 4208

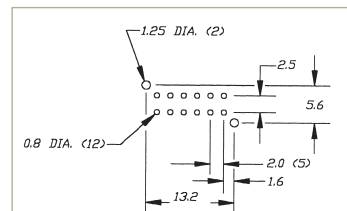
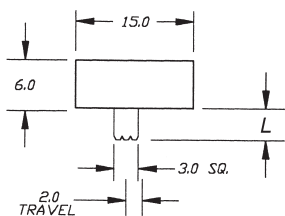

P.C. MOUNTING

Model No.	L
EG4208	4
EG4208A	6

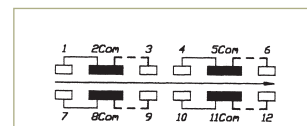
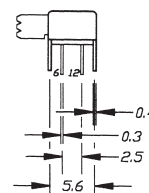
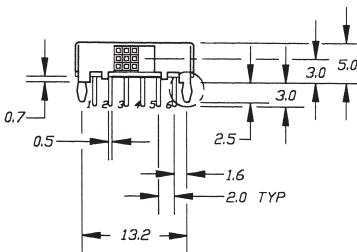

SCHEMATIC

EG 4311

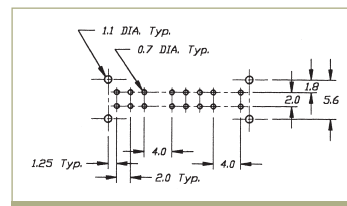
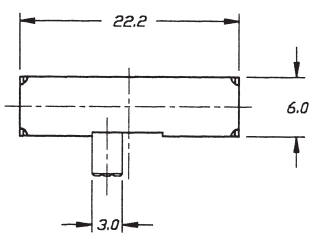

P.C. MOUNTING

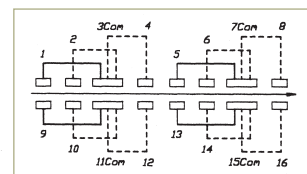
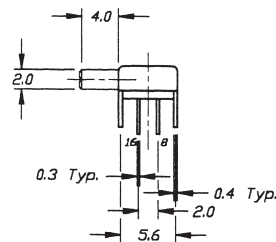
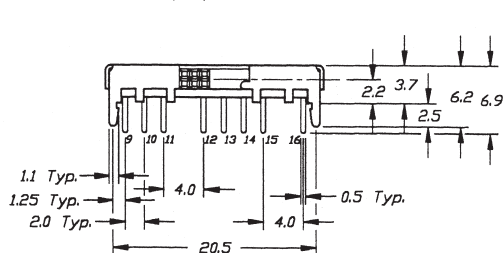

SCHEMATIC

TACT SWITCHES

NAVIGATION SWITCHES

PUSHBUTTON SWITCHES

TOGGLE SWITCHES

ROCKER SWITCHES

SLIDE SWITCHES

SNAP-ACTION SWITCHES

DIP SWITCHES

KEYLOCK SWITCHES

ROTARY SWITCHES

DETECTOR SWITCHES

CAP OPTIONS

SERIES EG SWITCHES

SLIDE SWITCHES

TACT SWITCHES

NAVIGATION SWITCHES

PUSHBUTTON SWITCHES

TOGGLE SWITCHES

ROCKER SWITCHES

SLIDE SWITCHES

SNAP-ACTION SWITCHES

DIP SWITCHES

KEYLOCK SWITCHES

ROTARY SWITCHES

DETECTOR SWITCHES

CAP OPTIONS

EG 4319

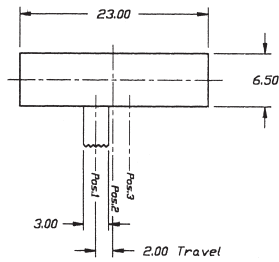
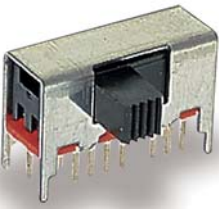

Model No.	L
EG4319	5
EG4319A	6

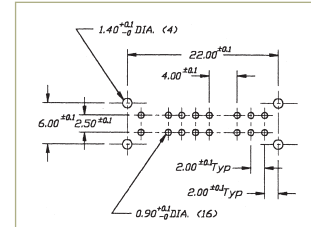
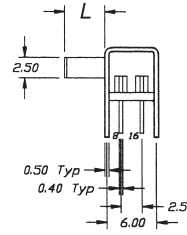
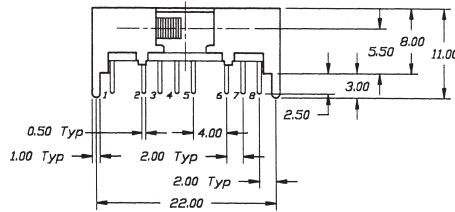

P.C. MOUNTING

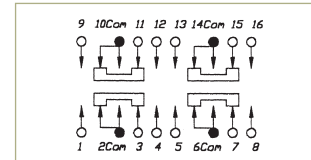

SCHEMATIC

EG 6201

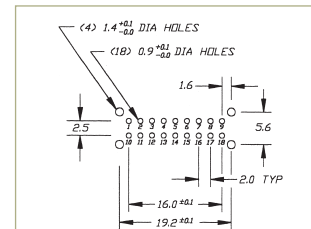
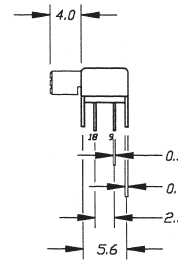
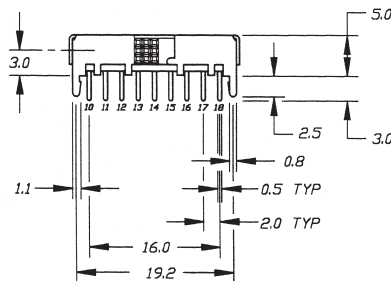
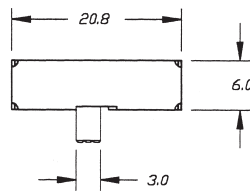

P.C. MOUNTING

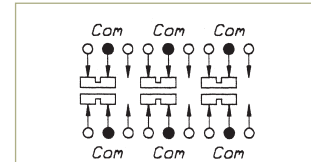

SCHEMATIC