



**SPECIFICATIONS**

Rating: 50mA @ 50 VDC  
 Electrical Life: 100,000 cycles typical  
 Contact Resistance: 50mΩ initial @ 2-4 VDC  
 100mA for both silver and gold plated contacts  
 Insulation Resistance: 100MΩ min.  
 Dielectric Strength: 1,000 Vrms at sea level  
 Operating Force: 130 ± 50 gf, 160 ± 50 gf, 300 ± 50 gf  
 Packaging: Through-hole in tubes

**MATERIALS**

Housing: Liquid Crystal Polymer (LCP)  
 Actuator: Liquid Crystal Polymer (LCP)  
 Cover: Tin plated steel or stainless steel  
 Seal: Silicon rubber  
 Contacts: Silver plated phosphor bronze, gold over nickel phosphor bronze  
 Terminals: Silver plated copper alloy, gold over nickel copper alloy

HOW TO ORDER

Series	Model No.	Actuator Length	Operating Force	Contact Material	Termination
<b>GS</b>	None = Standard E = Earth Ground R = Right Angle	4.70 5.20 6.34* 6.84* 6.90 8.54* 10.00 11.54*	F130 F160 F300	Q = Silver R = Gold	P = PC PIN G = Gull Wing

\*Actuator length for right angle version only.

SPECIFICATIONS SUBJECT TO CHANGE WITHOUT NOTICE.

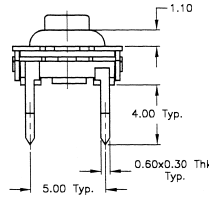
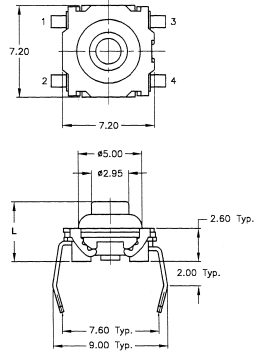

P.C. MOUNTING

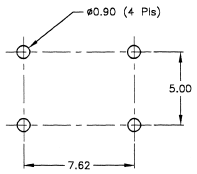

Schematic

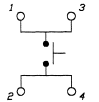

**EARTH GROUND**

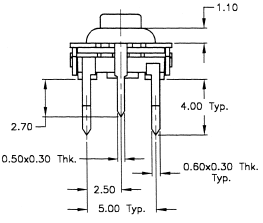
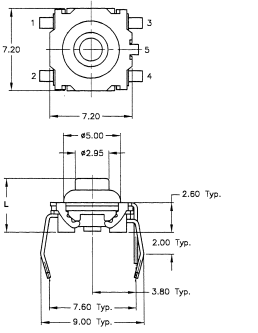

P.C. MOUNTING

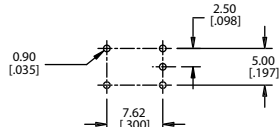

Schematic

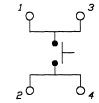

PROCESS SEALED TACT SWITCHES



**GSR**

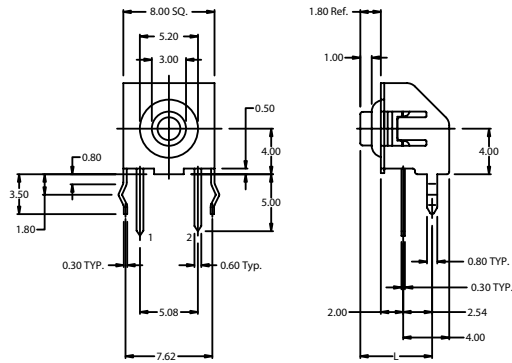

P.C. MOUNTING

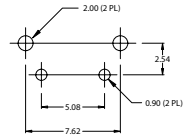

**Schematic**

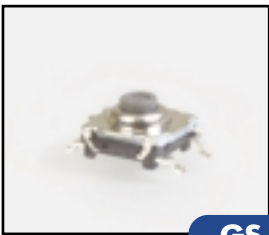
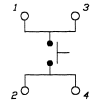

**GS**

**SMT**

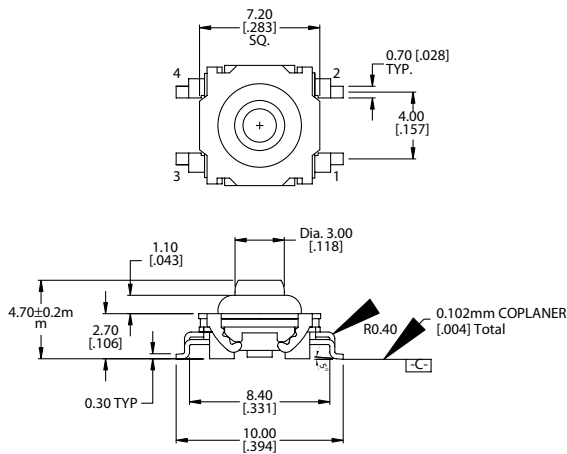

P.C. MOUNTING

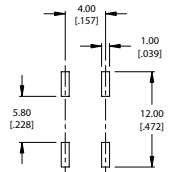

**Schematic**

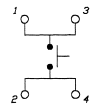

SPECIFICATIONS SUBJECT TO CHANGE WITHOUT NOTICE.