

GENERAL SPECIFICATIONS FOR S301 ~ S339

Electrical Capacity (Resistive & Inductive Load)

Power Level: Shown in the following tables













Other Ratings

- Contact Resistance:** 10 milliohms maximum
- Insulation Resistance:** 1,000 megohms minimum @ 500V DC
- Dielectric Strength:** 2,000V AC minimum
- Mechanical Life:** 50,000 operations minimum
- Electrical Life:** 15,000 operations minimum for S331s; 25,000 operations minimum for all others
- Angle of Throw (α):** Shown on following tables

Materials & Finishes

- Toggle:** Polyamide for flatted lever; brass with chrome plating for all others
- Bushing:** Brass with chrome plating
- Case:** Melamine phenol for S300s; phenolic resin for S330s
- Case Cover:** Steel with zinc plating
- Movable Contact:** Copper with silver plating
- Movable & Stationary Contacts:** Silver alloy capped on copper with silver plating
- Terminals:** Brass with silver plating

SINGLE POLE WITH SOLDER LUG

Model	Approvals	Pole & Throw	Toggle Position/Connected Terminals						Electrical Capacity				Angle of Throw
			Down 	Center 	Up 	Resistive			Inductive				
						AC 125V	AC 250V	DC 30V	AC 125V PF 0.6				
S301	 	SPST	ON 1-3	NONE	OFF —	15A	6A	20A	10A	32°			
S302	 	SPDT	ON 2-3	NONE	ON 2-1	15A	6A	20A	10A	32°			
S303	 	SPDT	ON 2-3	OFF	ON 2-1	15A	6A	20A	10A	32°			
S305	— 	SPDT	ON 2-3	NONE	MOM 2-1	15A	6A	20A	8A	32°			
S308	— 	SPDT	MOM 2-3	OFF	MOM 2-1	15A	6A	20A	8A	32°			
S309	— 	SPDT	ON 2-3	OFF	MOM 2-1	15A	6A	20A	8A	32°			

Throw & Schematics:

SPST  INTERNAL CONNECTION

SPDT  2 (COM)

Note: Terminal numbers are on the switch.

- Standard Hardware: AT503 Face Hex Nut, AT506 Locking Ring, AT508 Lockwasher, AT527M Backup Hex Nut. See Accessories & Hardware Index (page Y1) for details.
- Solder lug terminal hole accommodates one 10-gauge solid or stranded wire.



S301

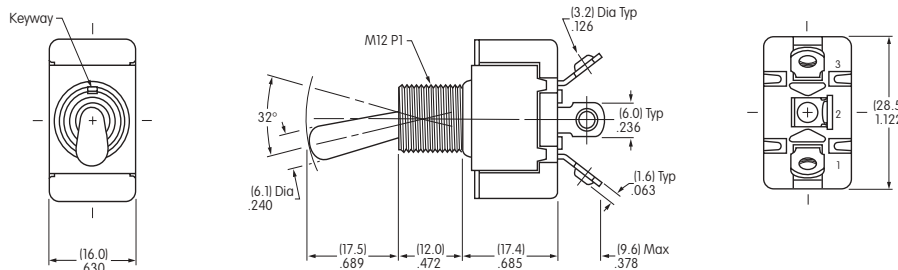

Max. Panel Thickness
4.7mm (.185")

S301 model does not have terminal 2.

DOUBLE POLE WITH SOLDER LUG

Model	Approvals	Pole & Throw	Toggle Position/Connected Terminals						Electrical Capacity				α = Angle of Throw
			Down Keyway	Center	Up		Resistive			Inductive AC 125V PF 0.6			
							AC 125V	AC 250V	DC 30V				
S331	RU SF	DPST	ON	1-3 4-6	NONE	OFF	—	25A	25A	25A	10A	25°	
S332	RU SF	DPDT	ON	2-3 5-6	NONE	ON	2-1 5-4	25A	15A	25A	10A	25°	
S333	RU SF	DPDT	ON	2-3 5-6	OFF	ON	2-1 5-4	25A	15A	25A	10A	30°	
S335	RU SF	DPDT	ON	2-3 5-6	NONE	MOM	2-1 5-4	15A	6A	20A	8A	25°	
S338	RU —	DPDT	MOM	2-3 5-6	OFF	MOM	2-1 5-4	15A	6A	20A	8A	25°	
S339	RU —	DPDT	ON	2-3 5-6	OFF	MOM	2-1 5-4	15A	6A	20A	8A	25°	

Throw & Schematics: DPST INTERNAL CONNECTION DPDT Note: Terminal numbers are on the switch.

- Standard Hardware: AT503 Face Hex Nut, AT506 Locking Ring, AT508 Lockwasher, AT527M Backup Hex Nut. See Accessories & Hardware Index (page Y1) for details.
- Solder lug terminal hole accommodates one 12-gauge solid or stranded wire.

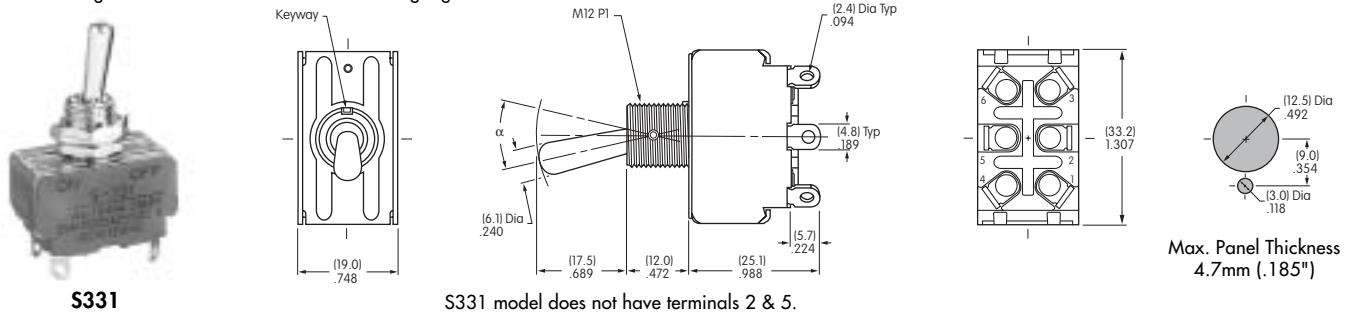

DOUBLE POLE WITH SOLDER LUG & FLATTED LEVER







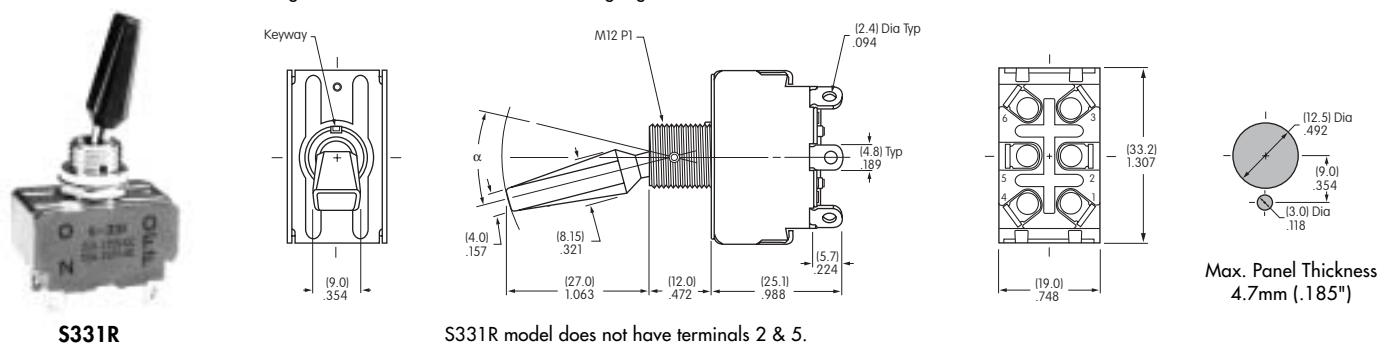





Model	Approvals	Pole & Throw	Toggle Position/Connected Terminals						Electrical Capacity				α = Angle of Throw
			Down Keyway	Center	Up		Resistive			Inductive AC 125V PF 0.6			
							AC 125V	AC 250V	DC 30V				
S331R	RU —	DPST	ON	1-3 4-6	NONE	OFF	—	25A	25A	25A	10A	25°	
S332R	RU —	DPDT	ON	2-3 5-6	NONE	ON	2-1 5-4	25A	15A	25A	10A	25°	
S333R	RU —	DPDT	ON	2-3 5-6	OFF	ON	2-1 5-4	25A	15A	25A	10A	30°	
S338R	RU —	DPDT	MOM	2-3 5-6	OFF	MOM	2-1 5-4	15A	6A	20A	8A	25°	
S339R	RU —	DPDT	ON	2-3 5-6	OFF	MOM	2-1 5-4	15A	6A	20A	8A	25°	



Throw & Schematics: DPST INTERNAL CONNECTION DPDT Note: Terminal numbers are on the switch.

- Standard Hardware: AT504M Knurled Nut, AT506 Locking Ring, AT508 Lockwasher, AT527M Backup Hex Nut. See Accessories & Hardware Index (page Y1) for details.
- Solder Lug terminal hole accommodates one 12-gauge solid or stranded wire.



SINGLE POLE WITH SCREW LUG

Model	Approvals	Pole & Throw	Toggle Position/Connected Terminals			Electrical Capacity				Angle of Throw
			Down 	Center 	Up 	Resistive			Inductive	
						AC 125V	AC 250V	DC 30V	AC 125V PF 0.6	
S301T	 	SPST	ON 1-3	NONE	OFF —	15A	6A	20A	10A	32°
S302T	 	SPDT	ON 2-3	NONE	ON 2-1	15A	6A	20A	10A	32°
S303T	 	SPDT	ON 2-3	OFF	ON 2-1	15A	6A	20A	10A	32°
S305T	— 	SPDT	ON 2-3	NONE	MOM 2-1	15A	6A	20A	8A	32°
S308T	— 	SPDT	MOM 2-3	OFF	MOM 2-1	15A	6A	20A	8A	32°
S309T	— 	SPDT	ON 2-3	OFF	MOM 2-1	15A	6A	20A	8A	32°

Throw & Schematics: SPST  INTERNAL CONNECTION SPDT  2 (COM)

Note: Terminal numbers are on the switch.

• Standard Mounting Hardware: AT503 Face Hex Nut, AT506 Locking Ring, AT508 Lockwasher, AT527M Backup Hex Nut.





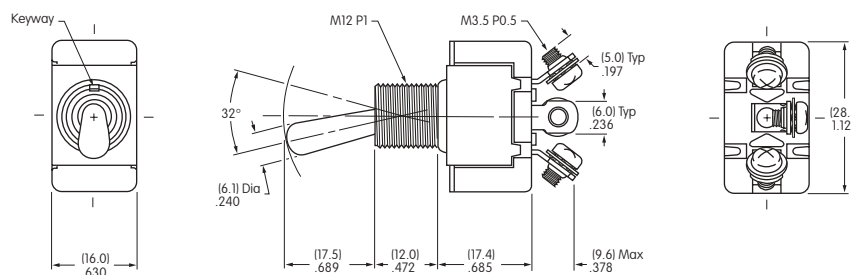





S301T





Max. Panel Thickness
4.7mm (.185")

S301T model does not have terminal 2.

DOUBLE POLE WITH SCREW LUG

Model	Approvals	Pole & Throw	Toggle Position/Connected Terminals			Electrical Capacity				α = Angle of Throw
			Down 	Center 	Up 	Resistive			Inductive	
						AC 125V	AC 250V	DC 30V	AC 125V PF 0.6	
S331T	 —	DPST	ON 1-3 4-6	NONE	OFF —	15A	15A	15A	10A	25°
S332T	 —	DPDT	ON 2-3 5-6	NONE	ON 2-1 5-4	15A	15A	15A	10A	25°
S333T	 —	DPDT	ON 2-3 5-6	OFF	ON 2-1 5-4	15A	15A	15A	10A	30°
S335T	 —	DPDT	ON 2-3 5-6	NONE	MOM 2-1 5-4	15A	6A	20A	8A	25°
S338T	 —	DPDT	MOM 2-3 5-6	OFF	MOM 2-1 5-4	15A	6A	20A	8A	25°
S339T	 —	DPDT	ON 2-3 5-6	OFF	MOM 2-1 5-4	15A	6A	20A	8A	25°

Throw & Schematics: DPST  INTERNAL CONNECTION DPDT  2 (COM) 5

Note: Terminal numbers are on the switch.

• Standard Mounting Hardware: AT503 Face Hex Nut, AT506 Locking Ring, AT508 Lockwasher, AT527M Backup Hex Nut.





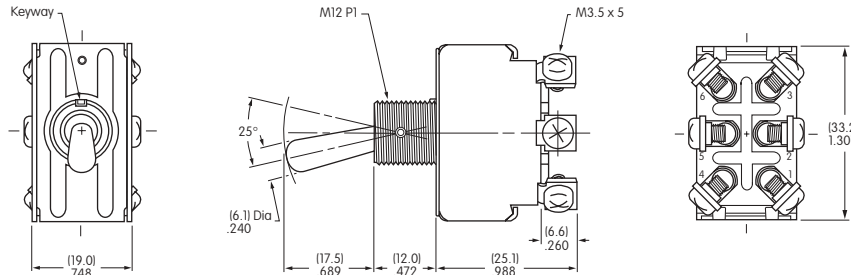







S331T



Max. Panel Thickness
4.7mm (.185")

S331T model does not have terminals 2 & 5.

SINGLE POLE WITH QUICK CONNECT

Model	Approvals	Pole & Throw	Toggle Position/Connected Terminals				Electrical Capacity				Angle of Throw
			Down 	Center 	Up 	Resistive			Inductive		
						AC 125V	AC 250V	DC 30V	AC 125V PF 0.6		
S301F	— 	SPST	ON 1-3 	NONE	OFF — 	15A	6A	20A	10A	32°	
Throw & Schematics: SPST  INTERNAL CONNECTION  SPDT  2 (COM) 						Note: Terminal numbers are on the switch.					

• Standard Mounting Hardware: AT503 Face Hex Nut, AT506 Locking Ring, AT508 Lockwasher, AT527M Backup Hex Nut.

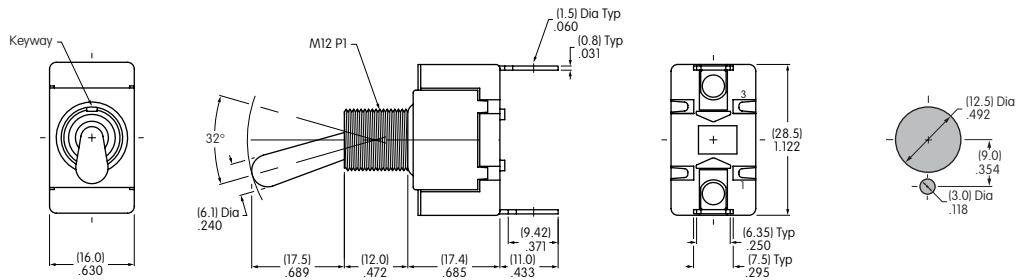













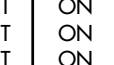
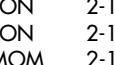

Max. Panel Thickness
4.7mm (.185")

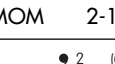
S301F

S301F model does not have terminal 2.

DOUBLE POLE WITH QUICK CONNECT

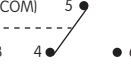
Model	Approvals	Pole & Throw	Toggle Position/Connected Terminals				Electrical Capacity				α = Angle of Throw
			Down 	Center 	Up 	Resistive			Inductive		
						AC 125V	AC 250V	DC 30V	AC 125V PF 0.6		
S331F	 —	DPST	ON 1-3 4-6 	NONE	OFF — 	25A	25A	25A	10A	25°	
S332F	 —	DPDT	ON 2-3 5-6 	NONE	ON 2-1 5-4 	25A	15A	25A	10A	25°	
S333F	 —	DPDT	ON 2-3 5-6 	OFF	ON 2-1 5-4 	25A	15A	25A	10A	30°	
S335F	 —	DPDT	ON 2-3 5-6 	NONE	MOM 2-1 5-4 	15A	6A	20A	8A	25°	
Throw & Schematics: DPST  INTERNAL CONNECTION  DPDT  2 (COM) 						Note: Terminal numbers are on the switch.					

• Standard Mounting Hardware: AT503 Face Hex Nut, AT506 Locking Ring, AT508 Lockwasher, AT527M Backup Hex Nut.

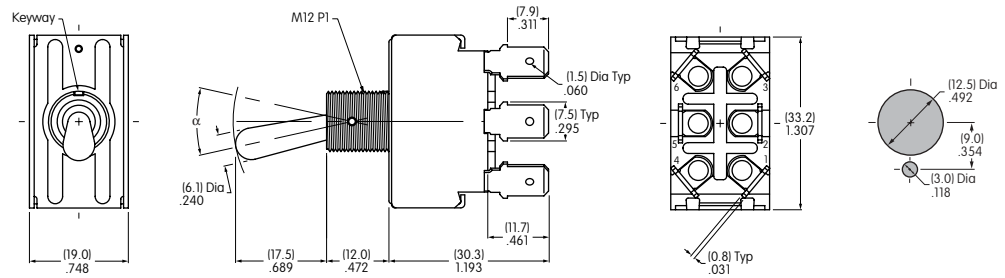

Max. Panel Thickness
4.7mm (.185")

S332F

S331F model does not have terminals 2 & 5.

GENERAL SPECIFICATIONS FOR S31 ~ S49

Electrical Capacity (Resistive & Inductive Load)

Power Level: Shown in the following tables

Other Ratings

Contact Resistance: 10 milliohms maximum
Insulation Resistance: 1,000 megohms minimum @ 500V DC
Dielectric Strength: 2,000V AC minimum
Mechanical Life: 50,000 operations minimum
Electrical Life: 25,000 operations minimum
Angle of Throw (α): Shown on following tables

Materials & Finishes

Toggle: PBT resin for flatted lever; brass with chrome plating for all others
Bushing: Brass with chrome plating
Case: Phenolic resin
Case Cover: Steel with zinc plating
Movable Contactor: Copper with silver plating
Movable Contacts: Silver alloy capped on copper with silver plating
Stationary Contacts: Silver alloy capped on copper with silver plating
Terminals: Brass with silver plating

Environmental Data

Operating Temp Range: -10°C through +70°C (+14°F through +158°F)

Installation

Mounting Torque: 30 kgf/cm (26 lb/in) for double nut; 15 kgf/cm (13 lb/in) for single nut
Maximum Panel Thickness: Shown beneath panel cutout in switch dimension drawings
Soldering Time & Temperature: 3 seconds @ 350°C or 5 seconds @ 270°C

Standards & Certifications

UL Recognized: Designated with UL recognized symbol beside part numbers on following pages
 See Supplement Index (page Z1) to find UL rating details. UL File No. E44145
 Add "/U" to end of part number to order UL mark on switch.
CSA Certified: Designated with CSA certified symbol beside part numbers on following pages
 See Supplement Index (page Z1) to find CSA rating details. File No. LR23535
 Add "/C" to end of part number to order CSA mark on switch.

THREE POLE WITH SOLDER LUG

*See page Z1 for UL detail.

Model	Approvals	Pole & Throw	Toggle Position/Connected Terminals						Electrical Capacity				α = Angle of Throw
			Down Keyway	Center	Up	Resistive			Inductive AC 125V PF 0.6				
						AC 125V	AC 250V	DC 30V					
S31	RU* (SF)	3P2ST	ON	1-3 4-6 7-9	NONE	OFF	—	25A	9A	20A	10A	25°	
S32	RU* (SF)	3PDT	ON	2-3 5-6 8-9	NONE	ON	2-1 5-4 8-7	25A	9A	20A	10A	25°	
S33	RU* (SF)	3PDT	ON	2-3 5-6 8-9	OFF	ON	2-1 5-4 8-7	25A	9A	20A	10A	30°	
S35	RU (SF)	3PDT	ON	2-3 5-6 8-9	NONE	MOM	2-1 5-4 8-7	15A	6A	20A	8A	25°	
S38	RU (SF)	3PDT	MOM	2-3 5-6 8-9	OFF	MOM	2-1 5-4 8-7	15A	6A	15A	8A	25°	
S39	RU (SF)	3PDT	ON	2-3 5-6 8-9	OFF	MOM	2-1 5-4 8-7	15A	6A	15A	8A	25°	

Throw & Schematics: 3PST INTERNAL CONNECTION 3PDT (COM) 8

Note: Terminal numbers are on the switch.

- Standard Hardware: AT503 Face Hex Nut, AT506 Locking Ring, AT508 Lockwasher, AT527M Backup Hex Nut. See Accessories & Hardware Index (page Y1) for details.
- Solder lug terminal hole accommodates one 12-gauge solid or stranded wire.



S32

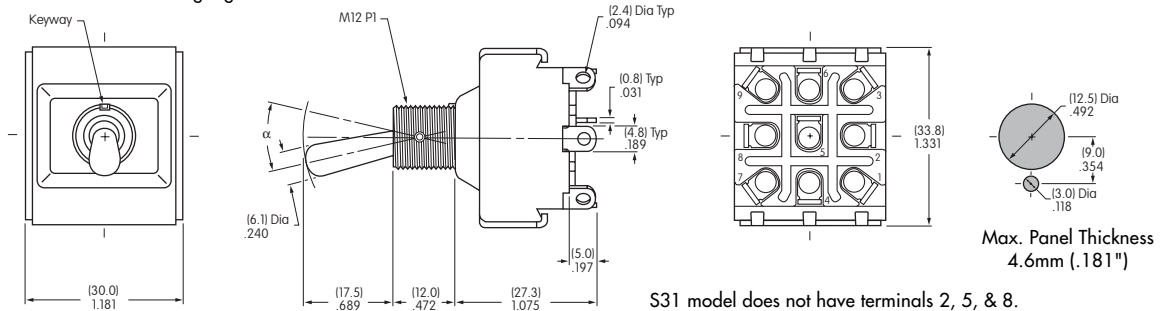

FOUR POLE WITH SOLDER LUG

*See page Z1 for UL & CSA details.

Model Suffix R= Flatted Lever	Approvals	Pole & Throw	Toggle Position/Connected Terminals						Electrical Capacity				α = Angle of Throw
			Down Keyway	Center	Up	Resistive			Inductive AC 125V PF 0.6				
						AC 125V	AC 250V	DC 30V					
S41/S41R	RU* (SF)	4PST	ON	1-3 4-6 7-9 10-12	NONE	OFF	—	25A	9A	20A	10A	25°	
S42/S42R	RU* (SF)	4PDT	ON	2-3 5-6 8-9 11-12	NONE	ON	2-1 5-4 8-7 11-10	25A	9A	20A	10A	25°	
S43/S43R	RU* (SF)	4PDT	ON	2-3 5-6 8-9 11-12	OFF	ON	2-1 5-4 8-7 11-10	25A	9A	20A	10A	30°	
S45	RU	4PDT	ON	2-3 5-6 8-9 11-12	NONE	MOM	2-1 5-4 8-7 11-10	15A	6A	20A	8A	25°	
S48/S48R	RU	4PDT	MOM	2-3 5-6 8-9 11-12	OFF	MOM	2-1 5-4 8-7 11-10	15A	6A	20A	8A	25°	
S49/S49R	RU	4PDT	ON	2-3 5-6 8-9 11-12	OFF	MOM	2-1 5-4 8-7 11-10	15A	6A	20A	8A	25°	

Throw & Schematics: 4PST INTERNAL CONNECTION 4PDT (COM) 8

Note: Terminal numbers are on the switch.



- Standard Hardware: AT503 Face Hex Nut, AT506 Locking Ring, AT508 Lockwasher, AT527M Backup Hex Nut. See Accessories & Hardware Index (page Y1) for details.
- Solder lug terminal hole accommodates one 12-gauge solid or stranded wire.

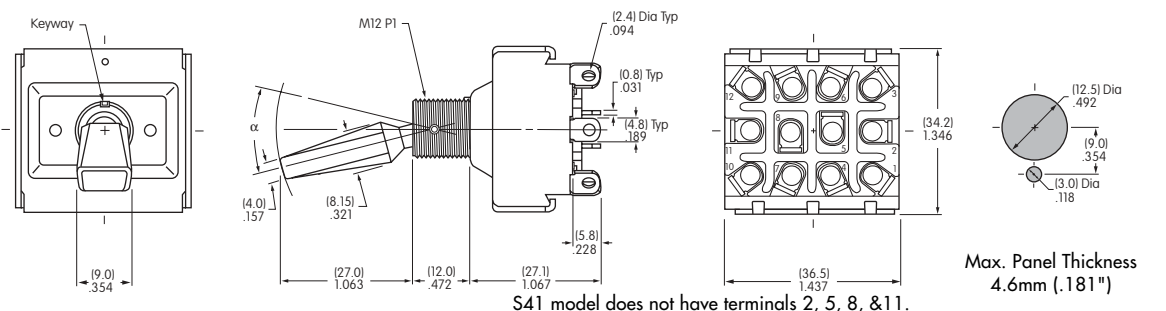

S42R



THREE POLE WITH SCREW LUG

*See page Z1 for CSA detail.			Toggle Position/Connected Terminals					Electrical Capacity					α = Angle of Throw
Model	Approvals	Pole & Throw	Down 	Center 	Up 	Resistive			Inductive				
						AC 125V	AC 250V	DC 30V	AC125V PF 0.6	AC250V PF 0.6			
S31T	— (SP)*	3PST	ON	1-3 4-6 7-9	NONE	OFF	—	25A	9A	20A	10A	5A	25°
S32T	— (SP)*	3PDT	ON	2-3 5-6 8-9	NONE	ON	2-1 5-4 8-7	25A	9A	20A	10A	5A	25°
S33T	— (SP)*	3PDT	ON	2-3 5-6 8-9	OFF	ON	2-1 5-4 8-7	25A	9A	20A	10A	5A	30°

Throw & Schematics:

3PST



INTERNAL CONNECTION

3PDT

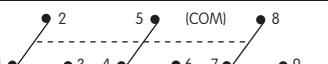

(COM)

Note: Terminal numbers are on the switch.

• Standard Hardware: AT503 Face Hex Nut, AT506 Locking Ring, AT508 Lockwasher, AT527M Backup Hex Nut. See Accessories & Hardware Index (page Y1) for details.



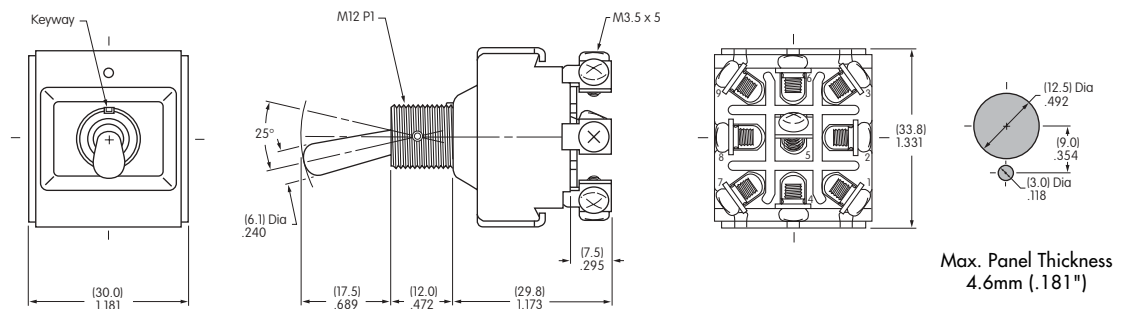

S32T



S31T model does not have terminals 2, 5, & 8.

FOUR POLE WITH SCREW LUG

*See page Z1 for CSA detail.			Toggle Position/Connected Terminals					Electrical Capacity					α = Angle of Throw
Model	Approvals	Pole & Throw	Down 	Center 	Up 	Resistive			Inductive				
						AC 125V	AC 250V	DC 30V	AC125V PF 0.6	AC250V PF 0.6			
S41T	— (SP)*	4PST	ON	1-3 4-6 7-9 10-12	NONE	OFF	—	25A	9A	20A	10A	5A	25°
S42T	— (SP)*	4PDT	ON	2-3 5-6 8-9 11-12	NONE	ON	2-1 5-4 8-7 11-10	25A	9A	20A	10A	5A	25°
S43T	— (SP)*	4PDT	ON	2-3 5-6 8-9 11-12	OFF	ON	2-1 5-4 8-7 11-10	25A	9A	20A	10A	5A	30°

Throw & Schematics:

4PST



INTERNAL CONNECTION

4PDT

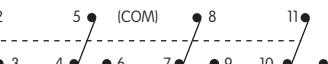

(COM)

Note: Terminal numbers are on the switch.

• Standard Hardware: AT503 Face Hex Nut, AT506 Locking Ring, AT508 Lockwasher, AT527M Backup Hex Nut. See Accessories & Hardware Index (page Y1) for details.





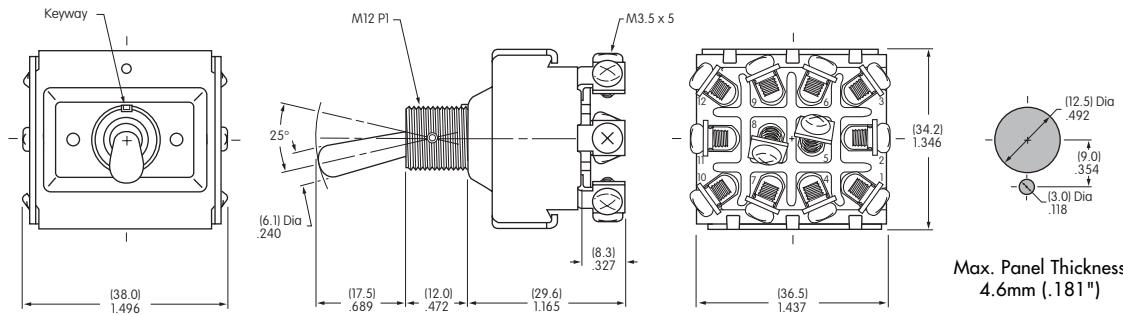





S42T



S41T model does not have terminals 2, 5, 8, & 11.

THREE POLE WITH QUICK CONNECT

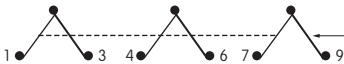
*See page Z1 for UL detail.			Toggle Position/Connected Terminals						Electrical Capacity				α = Angle of Throw
Model	Approvals	Pole & Throw	Down 	Center 	Up 	Resistive			Inductive				
						AC 125V	AC 250V	DC 30V	AC 125V PF 0.6				
S31F	 *	3PST	ON	1-3 4-6 7-9	NONE	OFF	—	25A	9A	20A	10A	25°	
S32F	 *	3PDT	ON	2-3 5-6 8-9	NONE	ON	2-1 5-4 8-7	25A	9A	20A	10A	25°	
S33F	 *	3PDT	ON	2-3 5-6 8-9	OFF	ON	2-1 5-4 8-7	25A	9A	20A	10A	30°	

Throw & Schematics: 3PST  INTERNAL CONNECTION  Note: Terminal numbers are on the switch.

• Standard Hardware: AT503 Face Hex Nut, AT506 Locking Ring, AT508 Lockwasher, AT527M Backup Hex Nut. See Accessories & Hardware Index (page Y1) for details.





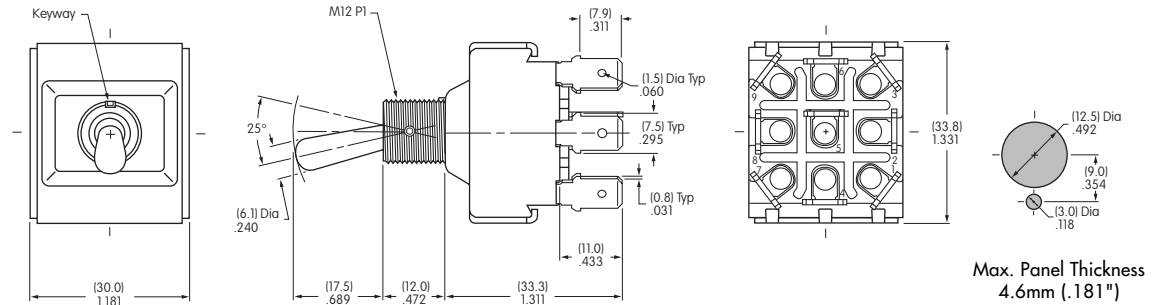





S32F



S31F model does not have terminals 2, 5, & 8.

FOUR POLE WITH QUICK CONNECT

*See page Z1 for UL detail.			Toggle Position/Connected Terminals						Electrical Capacity				α = Angle of Throw
Model	Approvals	Pole & Throw	Down 	Center 	Up 	Resistive			Inductive				
						AC 125V	AC 250V	DC 30V	AC 125V PF 0.6				
S41F	 *	4PST	ON	1-3 4-6 7-9 10-12	NONE	OFF	—	25A	9A	20A	10A	25°	
S42F	 *	4PDT	ON	2-3 5-6 8-9 11-12	NONE	ON	2-1 5-4 8-7 11-10	25A	9A	20A	10A	25°	
S43F	 *	4PDT	ON	2-3 5-6 8-9 11-12	OFF	ON	2-1 5-4 8-7 11-10	25A	9A	20A	10A	30°	

Throw & Schematics: 4PST  INTERNAL CONNECTION  Note: Terminal numbers are on the switch.

• Standard Hardware: AT503 Face Hex Nut, AT506 Locking Ring, AT508 Lockwasher, AT527M Backup Hex Nut. See Accessories & Hardware Index (page Y1) for details.



S42F

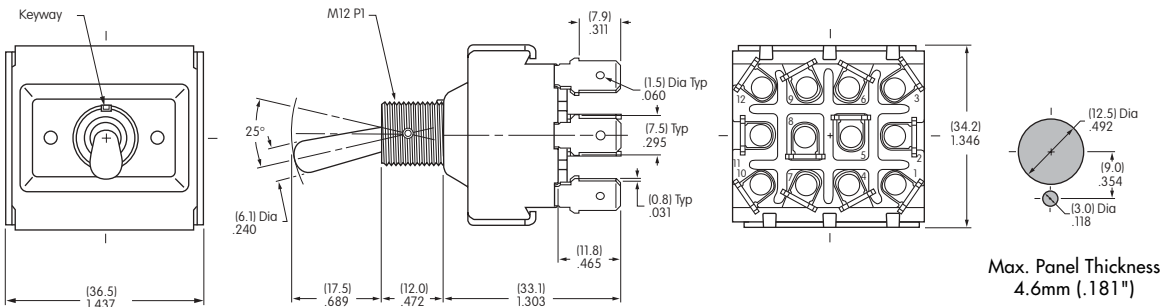

S41F model does not have terminals 2, 5, 8, & 11.

GENERAL SPECIFICATIONS FOR S421 ~ S429

Electrical Capacity (Resistive & Inductive Load)

Power Level: Shown in the following tables

Other Ratings

Contact Resistance:	10 milliohms maximum
Insulation Resistance:	1,000 megohms minimum @ 500V DC
Dielectric Strength:	2,000V AC minimum
Mechanical Life:	50,000 operations minimum for all other models
Electrical Life:	15,000 operations minimum
Angle of Throw (α):	Shown in tables on following pages

Materials & Finishes

Toggle:	Brass with chrome plating
Bushing:	Brass with chrome plating
Case:	Phenolic resin
Case Cover:	Steel with zinc plating
Movable Contactor:	Copper with silver plating
Movable Contacts:	Silver alloy capped on copper with silver plating
Stationary Contacts:	Silver alloy capped on copper with silver plating
Terminals:	Brass with silver plating



Environmental Data

Operating Temp Range: -10°C through +70°C (+14°F through +158°F)

Installation

Mounting Torque:	30 kgf/cm (26 lb/in) for double nut; 15 kgf/cm (13 lb/in) for single nut
Maximum Panel Thickness:	Shown beneath panel cutout in switch dimension drawings
Soldering Time & Temperature:	3 seconds @ 350°C or 5 seconds @ 270°C

DOUBLE POLE WITH SOLDER LUG

Model	Approvals	Pole & Throw	Toggle Position/Connected Terminals					Electrical Capacity				α = Angle of Throw	
			Down 	Center 	Up 	Resistive		Inductive		Motor Load			
						AC 125V	AC 250V	AC 125V	AC 250V	AC 125V			
S421	— —	DPST	ON	1-3 4-6	NONE	OFF	—	25A	25A	25A	25A	750W	24°
S422	— —	DPDT	ON	2-3 5-6	NONE	ON	2-1 5-4	25A	25A	25A	25A	750W	24°
S423	— —	DPDT	ON	2-3 5-6	OFF	ON	2-1 5-4	25A	25A	25A	25A	750W	28°
S425	— —	DPDT	ON	2-3 5-6	NONE	MOM	2-1 5-4	15A	15A	15A	15A	400W	24°
S428	— —	DPDT	MOM	2-3 5-6	OFF	MOM	2-1 5-4	15A	15A	15A	15A	400W	24°
S429	— —	DPDT	ON	2-3 5-6	OFF	MOM	2-1 5-4	15A	15A	15A	15A	400W	24°

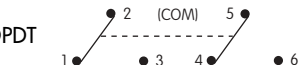

Throw & Schematics: DPST  INTERNAL CONNECTION DPDT  Note: Terminal numbers are on the switch.

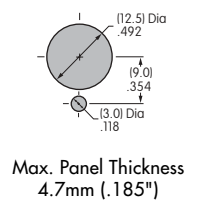
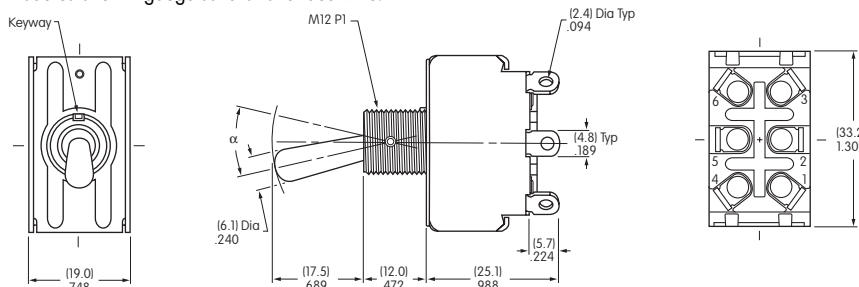
- Standard Hardware: AT503 Face Hex Nut, AT506 Locking Ring, AT508 Lockwasher, AT527M Backup Hex Nut. See Accessories & Hardware Index (page Y1) for details.
- Solder lug terminal hole accommodates one 12-gauge solid or stranded wire.



S421 model does not have terminals 2 & 5.

DOUBLE POLE WITH SCREW LUG

Model	Approvals	Pole & Throw	Toggle Position/Connected Terminals					Electrical Capacity				α = Angle of Throw	
			Down 	Center 	Up 	Resistive		Inductive		Motor Load			
						AC 125V	AC 250V	AC 125V	AC 250V	AC 125V			
S421T	— —	DPST	ON	1-3 4-6	NONE	OFF	—	20A	20A	20A	20A	750W	24°
S422T	— —	DPDT	ON	2-3 5-6	NONE	ON	2-1 5-4	20A	20A	20A	20A	750W	24°
S423T	— —	DPDT	ON	2-3 5-6	OFF	ON	2-1 5-4	20A	20A	20A	20A	750W	28°
S425T	— —	DPDT	ON	2-3 5-6	NONE	MOM	2-1 5-4	15A	15A	15A	15A	400W	24°
S428T	— —	DPDT	MOM	2-3 5-6	OFF	MOM	2-1 5-4	15A	15A	15A	15A	400W	24°
S429T	— —	DPDT	ON	2-3 5-6	OFF	MOM	2-1 5-4	15A	15A	15A	15A	400W	24°

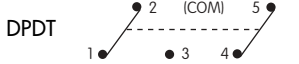
Throw & Schematics: DPST  INTERNAL CONNECTION DPDT  Note: Terminal numbers are on the switch.

- Standard Hardware: AT503 Face Hex Nut, AT506 Locking Ring, AT508 Lockwasher, AT527M Backup Hex Nut. See Accessories & Hardware Index (page Y1) for details.

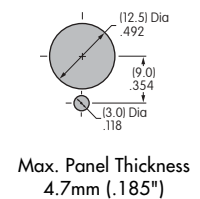
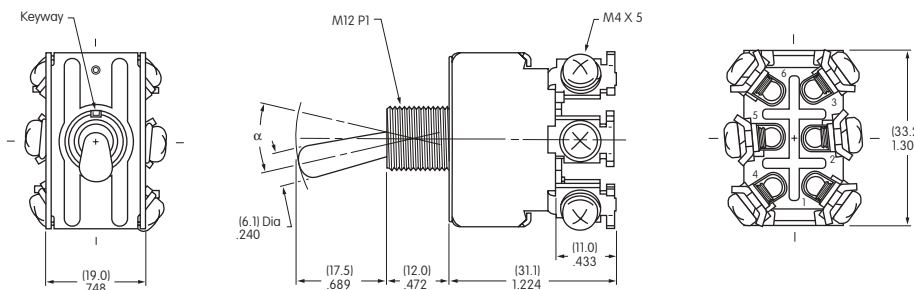

S421T model does not have terminals 2 & 5.