

TST Series - Page C5

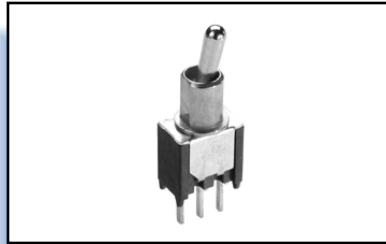

TT Series - Page C8

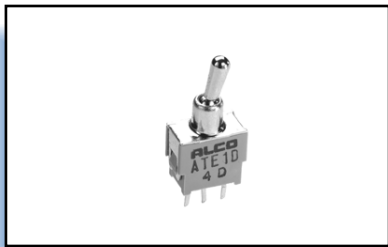

ATE Series - Page C19



A Series - Page C22

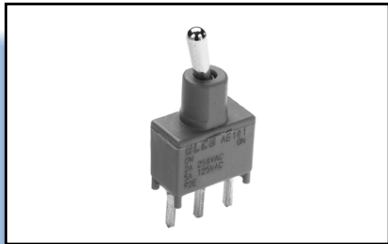

AE Series - Page C35



MT Series - Page C43

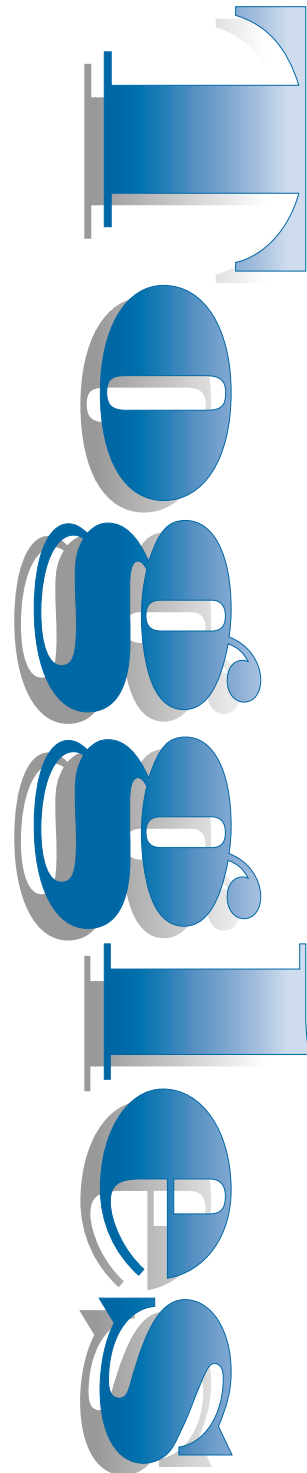

Toggle Switches Part Number Index

A101K1V30BC22	A107KAV2Q.....C22	A208SD9AV2QC22,C31	AE108SD1V30BC35
A101KABC22	A107KZBC22	A208SDCQC30	AE201MD1ABC40
A101KAQC22	A107MD9AV2BC22	A208SYABC28	AE201MD1AQC40
A101KCCC22	A107MD9CQC22	A208SYCBC22,C28	AE201MD1AV2BC41
A101KD9AQC22	A107MD9V30QC22	A208SYCQC22	AE201MD1AV2QC41
A101KZQC22,C31	A107P3YZQC22,C33	A208SYZQC22,C27	AE201MD1CBC41
A101KZQ2C22	A107SYAQC22	A208TIZQC22,C34	AE201MD1CQC41
A101MD9ABC22,C32	A107SYCBC22	A208TZQC22	AE201MD1V30BC35
A101MD9AGC22	A107SYCQC22	A211KZBC22,C31	AE201SD1ABC42
A101MD9AQC22,C32	A107SYZBC27	A211KZQC31	AE201SD1AGC35
A101MD9AV2BC22,C32	A107SYZQC22,C27	A211MD9AQC22	AE201SD1AQC42
A101MD9AV2GC22	A107TZBC22	A211MYCQC22	AE201SD1AV2BC42
A101MD9AV2QC22,C32	A108MD9ABC22,C32	A211P3YCQC22	AE201SD1AV2QC42
A101MD9V30BC22	A108MD9AQC32	A211P3YV40GULC22	AE201SD1CBC39
A101MDAQC22	A108MD9AV2QC32	A211P3YZQC22,C33	AE201SD1CQC39
A101MDAV2BC22	A108MD9CQC22,C32	A211SCWCQOC22	AE201SD1CQULC35
A101MDCGC22	A108MD9AQC32	A211SDZQC22	AE203MD1ABC40
A101MDZGC22	A108MD9AV2QC32	A211SHZQC22	AE203MD1AQC40
A101MYCQC22	A108MD9CQC22,C32	A211SY9AQC22	AE203MD1AV2BC41
A101MYZQC22	A108MD9ABC22	A211SYCQC22	AE203MD1AV2QC41
A101P3CWV30BC22	A108MD9AQC32	A211SYZBC22	AE203MD1CBC41
A101P3YCBC22	A108MD9AV2QC32	A211SYZQC22,C27	AE203MD1CQC41
A101P3YZQC22,C33	A108MD9CQC22,C32	A211TZQC22,C34	AE203MD1V30QC35
A101P4DCBC22	A108MD9AQC32	A212TZQC33	AE203SD1ABC42
A101P4YCBC22	A108MD9AV2QC32	A213P4YZQC22	AE203SD1AQC42
A101SCWCQOC22	A108MD9CQC22,C32	A213SYZQC22,C27	AE203SD1AV2BC42
A101SCWZQC22	A108MD9ABC22	A215P3YZQC33	AE203SD1AV2QC42
A101SD9ABC22,C30	A108MD9AQC32	A215SD9V30BC22	AE203SD1CBC39
A101SD9AQC22,C30	A108MD9AV2QC32	A215SY9AQC22	AE203SD1CQC35,C39
A101SD9AV2BC22	A108MD9CQC22,C32	A215SYZQC22,C27	AE205MD1AV2BC35
A101SD9AV2QC22,C31	A108MD9ABC22	AE101MD1ABC40	AE205MD1CBC41
A101SD9V30BC22	A108MD9AQC32	AE101MD1AGC35	AE205MD1CQC41
A101SD9V30QC22	A108MD9AV2QC32	AE101MD1AGULC35	AE205SD1CBC39
A101SDCQC22,C30	A108MD9CQC22,C32	AE101MD1AQC40	AE205SD1CQC39
A101SDZQC22,C29	A108MD9ABC22	AE101MD1AV2BC40	AE205SD1CQULC35
A101SHZQC22	A108MD9AQC32	AE101MD1AV2QC40	AE207MD1ABC35
A101SY9CQULC22	A108MD9AV2QC32	AE101MD1AV2QULC35	AE207MD1CBC41
A101SYABC22,C28	A108MD9CQC22,C32	AE101MD1CBC41	AE207MD1CQC41
A101SYAQC22	A108MD9ABC22	AE101MD1CGC35	AE207SD1CBC39
A101SYCBC22,C28	A108MD9AQC32	AE101MD1CQC41	AE207SD1CQC39
A101SYCQC22	A108MD9AV2QC32	AE101MD1V30BC35	AE208MD1ABC40
A101SYCQULC22	A108MD9CQC22,C32	AE101MD1V30QULC35	AE208MD1AQC40
A101SYWQC22,C29	A108MD9ABC22	AE101MD1ZQC35	AE208MD1AV2BC41
A101SYZBC22,C27	A108MD9AQC32	AE101SD1ABC42	AE208MD1AV2QC41
A101SYZQC22,C27	A108MD9AV2QC32	AE101SD1AQC42	AE208MD1CBC41
A101SYZQNC22	A108MD9CQC22,C32	AE101SD1AQULC35	AE208MD1CQC41
A101SYZQLC22	A108MD9ABC22	AE101SD1AV2BC42	AE208SD1ABC42
A101TIZBC22	A108MD9AQC32	AE101SD1AV2QC42	AE208SD1AQC42
A101TIZQC22,C34	A108MD9AV2QC32	AE101SD1CBC39	AE208SD1AV2BC42
A101TCQC22	A108MD9CQC22,C32	AE101SD1CQC39	AE208SD1AV2QC42
A101TZQC22,C33	A108MD9ABC22	AE101SD1V30BC35	AE208SD1CBC39
A103KZQC22,C31	A108MD9AQC32	AE101SD1V30QULC35	AE208SD1CQC39
A103MD9ABC22,C32	A108MD9AV2QC32	AE103MD1ABC40	AE211MD1CBC41
A103MD9AGC22	A108MD9CQC22,C32	AE103MD1AQC40	AE211MD1CQC41
A103MD9AQC22,C32	A108MD9ABC22	AE103MD1AV2BC40	AE211MD1V30BC35
A103MD9AV2BC22,C32	A108MD9AQC32	AE103MD1AV2QC40	AE211SD1CBC39
A103MD9AV2QC32	A108MD9AV2QC32	AE103MD1CBC41	AE211SD1CQC39
A103P3YZQC22,C33	A108MD9CQC22,C32	AE103MD1CQC41	AE215MD1CBC41
A103SD9ABC30	A108MD9ABC22	AE103MD1V30BC35	AE215MD1CQC41
A103SD9AQC22,C30	A108MD9AQC32	AE103SD1ABC42	AE215SD1CBC39
A103SD9AV2BC22	A108MD9AV2QC32	AE103SD1AQC42	AE215SD1CQC39
A103SD9AV2QC22,C31	A108MD9CQC22,C32	AE103SD1AV2BC42	ATE1DGPCLC20
A103SDCBC22	A108MD9ABC22	AE103SD1AV2QC42	ATE1DGPC7C20
A103SDCQC22,C30	A108MD9AQC32	AE103SD1CBC39	ATE1DGRA1C21
A103SDZQC22,C29	A108MD9AV2QC32	AE103SD1CQC39	ATE1DGRA7C21
A103SYABC28	A108MD9CQC22,C32	AE103SD1CQULC35	ATE1EGPC1C20
A103SYAQC22	A108MD9ABC22	AE103SD1V30BC35	ATE1EGRA1C21
A103SYAV2QC22	A108MD9AQC32	AE105MD1ABC35	ATE1EGRA7C21
A103SYCBC22,C28	A108MD9AV2QC32	AE105MD1AGC35	ATE1FGPC1C20
A103SYCQC22	A108MD9CQC22,C32	AE105MD1AV2BC35	ATE1FGRA1C21
A103SYWBC22	A108MD9ABC22	AE105MD1CBC41	ATE1FGRA7C21
A103SYWQC22,C29	A108MD9AQC32	AE105MD1CQC41	ATE1GGPC1C20
A103SYZBC22,C27	A108MD9AV2QC32	AE105SD1CBC39	ATE1GGRA1C21
A103SYZQC22,C27	A108MD9CQC22,C32	AE105SD1CQC39	ATE2DGPC1C20
A103TICGC22	A108MD9ABC22	AE105SD1V30BC35	ATE2DGPC7C20
A103TIZQC22,C34	A108MD9AQC32	AE107MD1AV2BC35	ATE2DGRA1C21
A103TZQC22,C33	A108MD9AV2QC32	AE107MD1CBC41	ATE2EGPC1C20
A105MD9ABC22	A108MD9CQC22,C32	AE107MD1CQC41	ATE2EGRA7C21
A105MD9AQC22	A108MD9ABC22	AE107SD1ABC35	ATE2GGRA1C21
A105MYV30QC22	A108MD9AQC32	AE107SD1AGC35	ATE4DGPAC2C19
A105P3YCGC22	A108MD9AV2QC32	AE107SD1CBC39	ATE4DGRA2C19
A105P3YCQC22	A108MD9CQC22,C32	AE107SD1CQC39	B10480C55
A105P3YZQC22,C33	A108MD9ABC22	AE107SD1V30BC35	B10482C55
A105P4YAV2BC22	A108MD9AQC32	AE108MD1ABC40	B10488C55
A105SD9ABC22	A108MD9AV2QC32	AE108MD1AQC40	B14400C55
A105SD9AV2QULC22	A108MD9CQC22,C32	AE108MD1AV2BC40	B14402C55
A105SD9V30BC22	A108MD9ABC22	AE108MD1AV2QC40	B14408C55
A105SYABC22	A108MD9AQC32	AE108MD1CBC41	B15320C55
A105SYAV2BC22	A108MD9AV2QC32	AE108MD1CQC41	B15322C55
A105SYCBC22	A108MD9CQC22,C32	AE108SD1ABC42	B15328C55
A105SYCQC22	A108MD9ABC22	AE108SD1AQC42	B2100C55
A105SYWBC22	A108MD9AQC32	AE108SD1AV2BC42	B2210C55
A105SYWQC22,C29	A108MD9AV2QC32	AE108SD1AV2QC42	BT1400C55
A105SYZBC22,C27	A108MD9CQC22,C32	AE108SD1CBC39	BT1400C55
A105SYZQC22,C27	A108MD9ABC22	AE108SD1CQC39	BT14402C55
A105TIZBC22	A108MD9AQC32	AE108SD1CQULC35	
A105TIZQC22,C34	A108MD9AV2QC32		
A105TZQC22	A108MD9CQC22,C32		

Toggle Switches, Poles, Throws & Functions Selection Guide

SERIES/CURRENT RATING/PAGE NUMBER

ATE Series0.4VAPage C19
 A/AE Series 0.4VA ..5 Amps.....Page C22/35

TT Series0.4VA 3 AmpsPage C8
 TST Series0.4VAPage C5
 MT Series6 AmpsPage C43

C
Toggle Switch Selection Guide

	SPDT	DPDT	3PDT	4PDT
On - None - On 2 Position	ATE Gemini Tiny/TST Green	ATE Gemini Tiny Green	Green	Tiny Green ATE
On - Off - On 3 Position	ATE Gemini Tiny/TST Green	ATE Gemini Tiny Green	Green	Tiny Green
On - None - (On) 2 Position	ATE Gemini Tiny/TST Green	Gemini Tiny Green	Green	Tiny
(On) - Off - (On) 3 Position	ATE Gemini Green TST	ATE Gemini Green	Green	
On - Off - (On) 3 Position	Gemini Green	Gemini Green	Green	
On - On - On 3 Position		Gemini Green		Green
(On) - On - (On) 3 Positions		Gemini Green		
On - On - (On) 3 Position		Gemini Green		
On - Off 2 Position	Tiny	Tiny		

Toggle Switches, Tiny, Sealed, Through Hole and Surface Mount

TST Series

FEATURES:

- Rating 0.4VA max. at 20VAC/DC
- High temperature plastics - Liquid crystal polymer (LCP)
- Specifically designed for thru-hole and surface mount applications - Tin lead plated terminals
- Washable process sealed construction - Internal actuator "O" Ring
- Ultrasonic welded case

MATERIAL SPECIFICATIONS:

ContactsCopper alloy with gold over nickel plate
 Case MaterialLCP
 Actuator MaterialNickel plated brass
 TerminalsCopper alloy with gold over nickel plating inside, tin plating outside
 Terminal SealEpoxy
 Support BracketTin plated steel

TYPICAL PERFORMANCE CHARACTERISTICS:

Contact Rating0.4 VA @ 20 VAC/DC
 Initial Contact Resistance20 Milliohms max.
 Contact TimingBreak-before-make
 Insulation Resistance1,000 Megohms 500 VDC min.
 Dielectric Strength1,000 Volt RMS @ sea level
 Actuator Travel22° for E and D function
 18° for F, G function
 Life ExpectancyD Function: Up to 80,000 cycles
 E Function: Up to 60,000 cycles
 F, G Function: Up to 30,000 cycles

ENVIRONMENTAL SPECIFICATIONS

Operating Temperature.....-22°F to +185°F (-30°C to +85°C)
 Storage Temperature.....-67°F to +185°F (-55°C to +85°C)

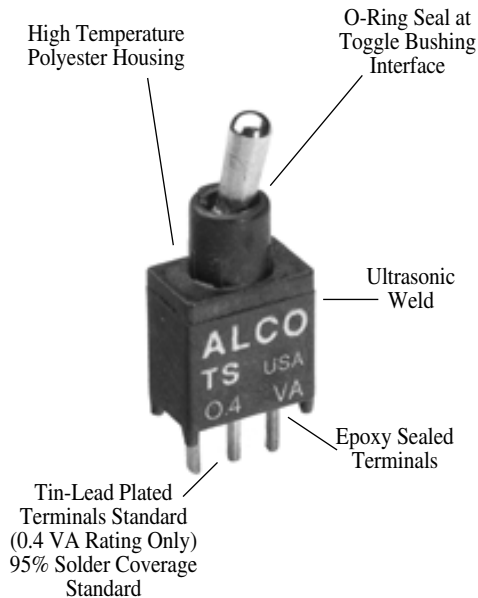

FUNCTION CHART

The following functions available in single pole.

- None - indicates no mechanical position.
- Off - indicates a mechanical position with no electrical connection.
- (On) - indicates momentary connection.

D	2 Positions	On	None	On
E	3 Positions	On	Off	On
F	2 Positions	On	None	(On)
G	3 Positions	(On)	Off	(On)
Terminals Connected		1-2	-	2-3

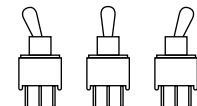

PART NUMBERING MATRIX

Model	No. of Poles	Contact Rating	Function	Contact Plating	Terminations	Actuator	Bushing (Plain)
TST	1	1	<ul style="list-style-type: none"> D on none on E on off on F on none(on) G (on) off (on) 	G	<ul style="list-style-type: none"> PC P.C. RA Right Angle VRA Vertical Right Angle SPC SurfaceMount SRA Surface Mount R.A. SRAB SurfaceMount R.A. Butt 	<ul style="list-style-type: none"> 1 .206" 2 .250" 4 .400" 	D

APPLICATION NOTE:

For sealed pushbutton switches, see page D3 - D5

Toggle Switches, Tiny, Sealed, Through Hole and Surface Mount

PC MOUNT **PC**

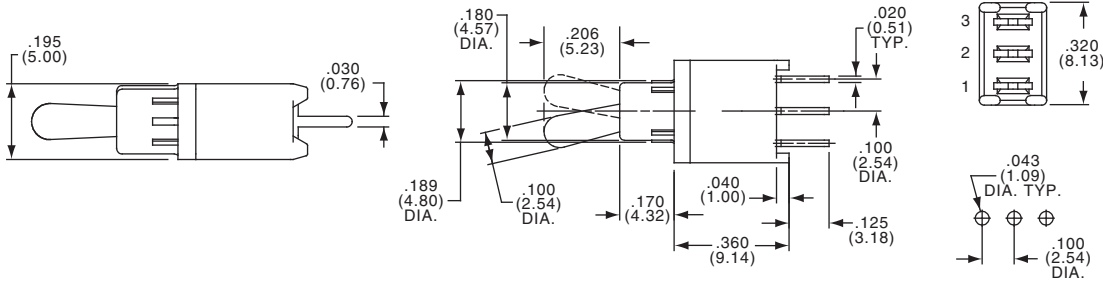

TST11DGPC1D

SURFACE MOUNT RIGHT ANGLE "L" BEND **SRA**

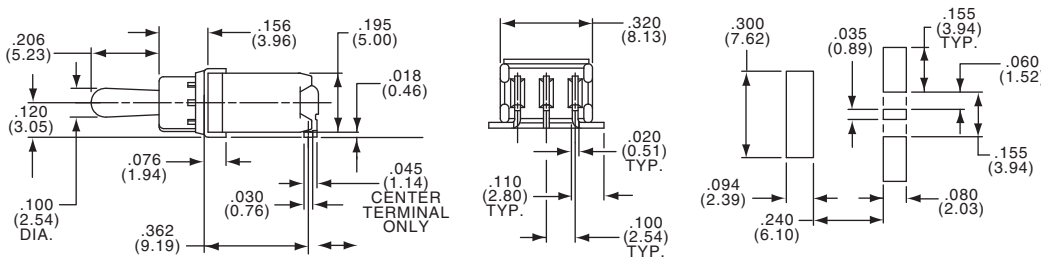

TST11DGSRA1D

SURFACE MOUNT **SPC**

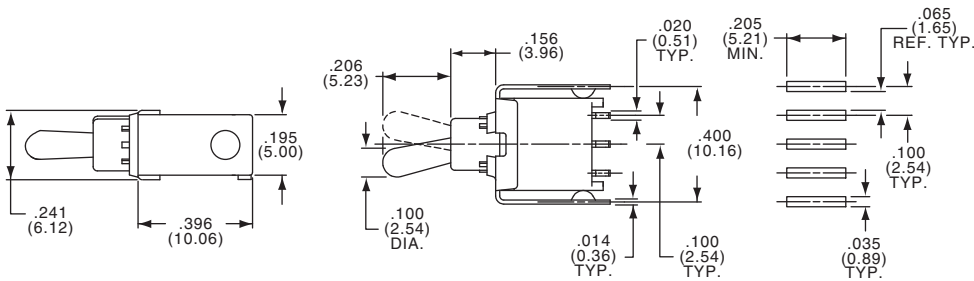

TST11DGSPC1D

SURFACE MOUNT RIGHT ANGLE BUTT **SRAB**

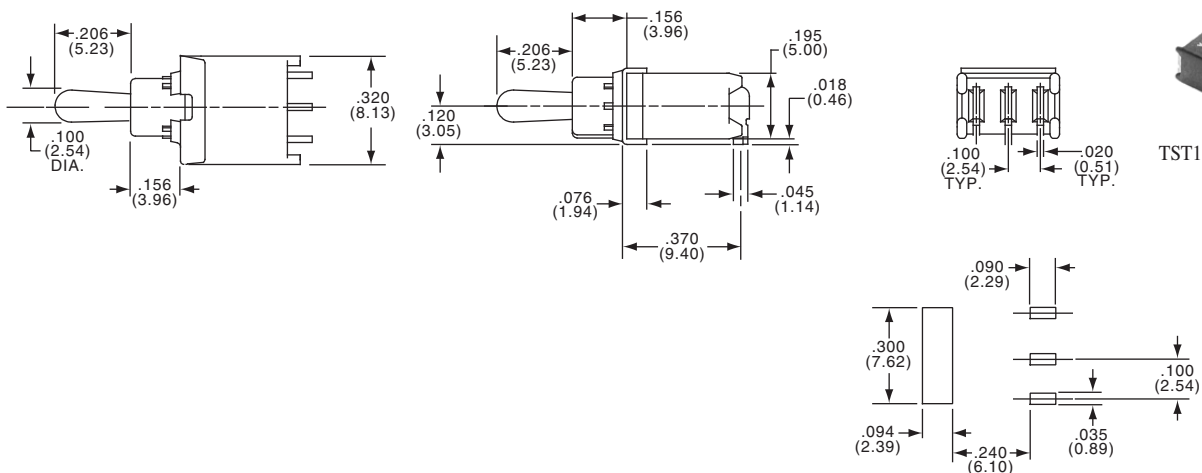

TST11DGSRA1D

Toggle Switches, Tiny, Sealed, Through Hole and Surface Mount

RA

Right Angle

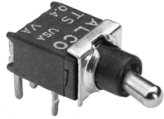

TST11DGRA1D

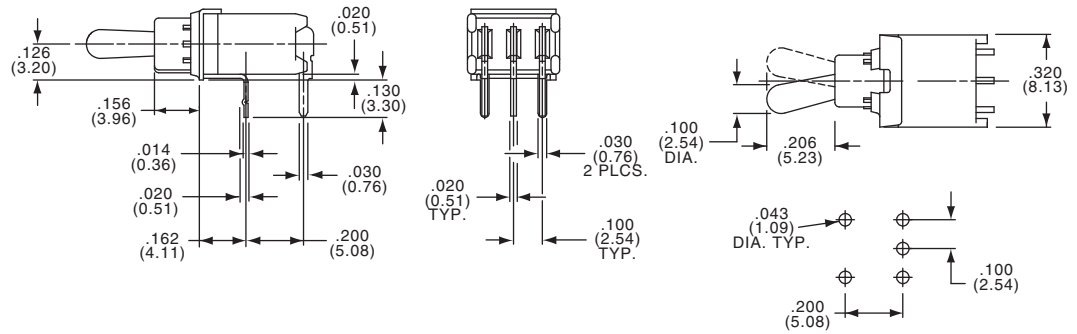

VRA

Vertical Right Angle



TST11DGVRA1D

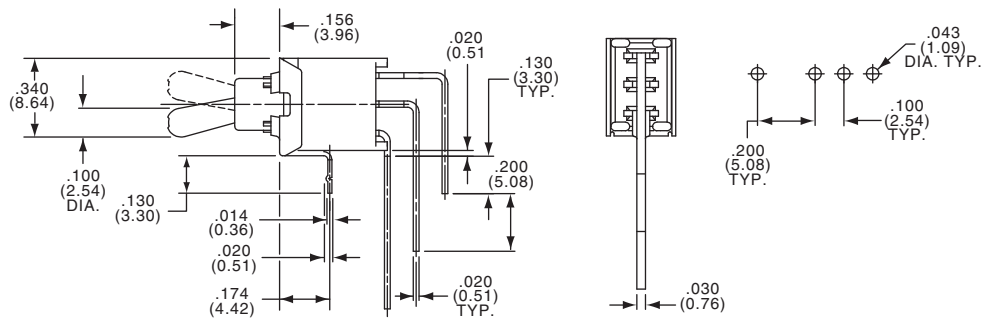

ACTUATORS

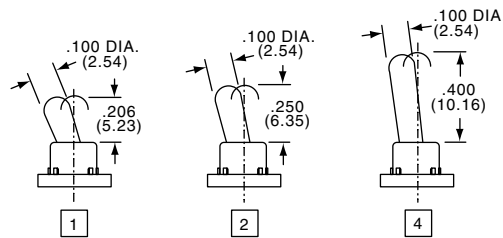

TST Series

Toggle Switches, Tiny, Part Number Matrix

MATERIAL SPECIFICATIONS:

Contacts.....Gold over nickel or silver plate
 Case Material.....Thermoplastic 94V-0
 Terminals/Fixed Contacts.....Tin lead plate
 Terminal Seal.....Epoxy on single pole, optional
 on double pole
 Process Seal.....ES version only (see page C16 - C17)

ENVIRONMENTAL SPECIFICATIONS

Operating Temperature.....-22°F to +185°F (-30°C to +85°C)
 Storage Temperature.....-67°F to +185°F (-55°C to +85°C)
 Solder Heat Resistance.....See page M3-4
 U.L. (File E-46765).....Silver only

TYPICAL PERFORMANCE CHARACTERISTICS:

Contact Rating..... Gold: 0.4 VA max. @ 20 VDC or peak AC
 Silver (2 pos.): 3 A @ 125 VAC or 28 VDC
 Silver (3 pos.): 2 A @ 125 VAC or 28 VDC
 Initial Contact Resistance..... 20 Milliohms max.
 Contact Timing..... Break before Make
 Insulation Resistance..... 1,000 Megohms 500 VDC min.
 Dielectric Strength..... 1,000 Volts RMS @ sea level
 Plunger/Actuator Travel..... 26°
 High Torque Bushing Shoulder Yes
 Life Expectancy..... See chart below
 Note: Hardware included with switch

TT Series

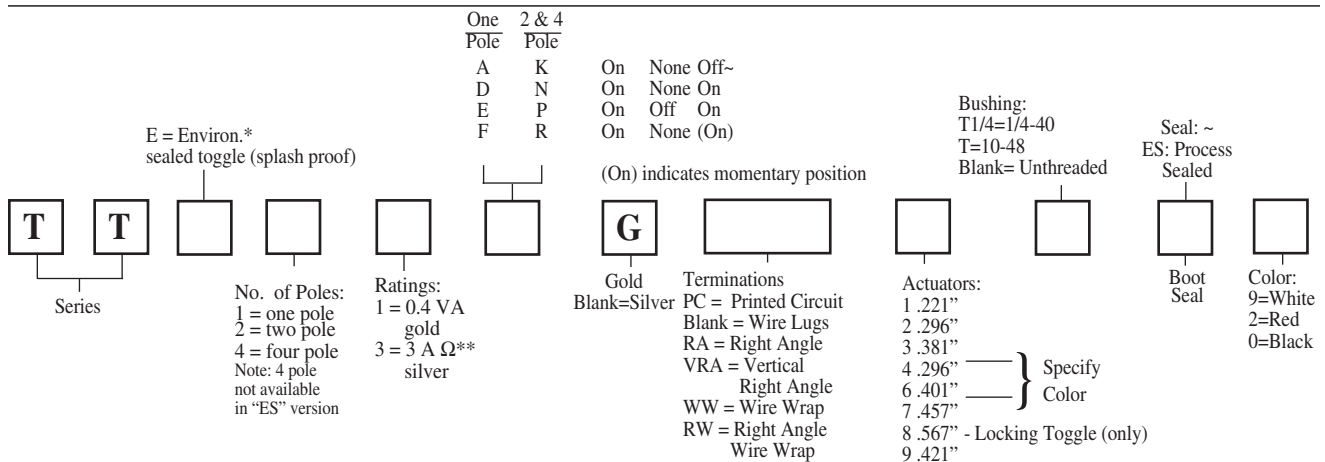

One Pole	0.4VA	80,000 (2 Pos.)	60,000 (3 Pos.)
Two Pole	0.4VA	80,000 (2 Pos.)	60,000 (3 Pos.)
Three Pole	3 Amp	20,000 (2 Pos.)	10,000 (3 Pos.)
Four Pole	0.4VA	80,000 (2 Pos.)	60,000 (3 Pos.)
Three Pole	3 Amp	20,000 (2 Pos.)	10,000 (3 Pos.)

APPLICATION NOTE:

For surface mount termination, use the "TST" series on page C5.
 For 3 pole refer to the MT Series on page C43

Actuator Dimensions shown with	
1,2,3,4,6	10-48 bushing
7,8,9	1/4-40 bushing

* Not available on 7 actuator or with VRA.
 ** Not available in RA.
 Ω Available in PC & WL only.
 ~ Available in WL & PC only.

TERMINATIONS

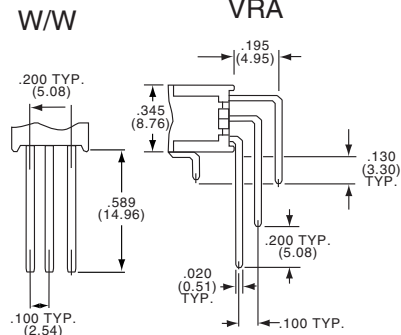
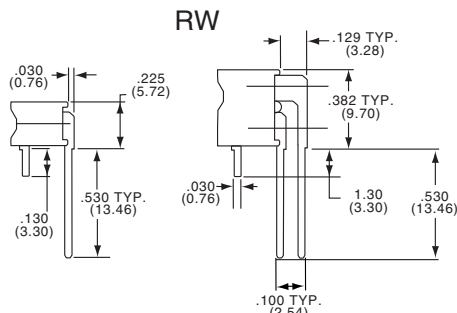
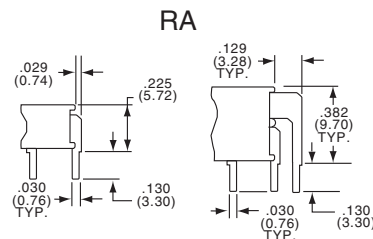
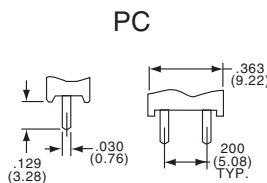
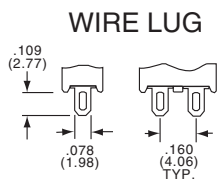

Toggle Switches, Tiny, Actuator and Bushing Options

Toggle Cap
Series C-11*
Available

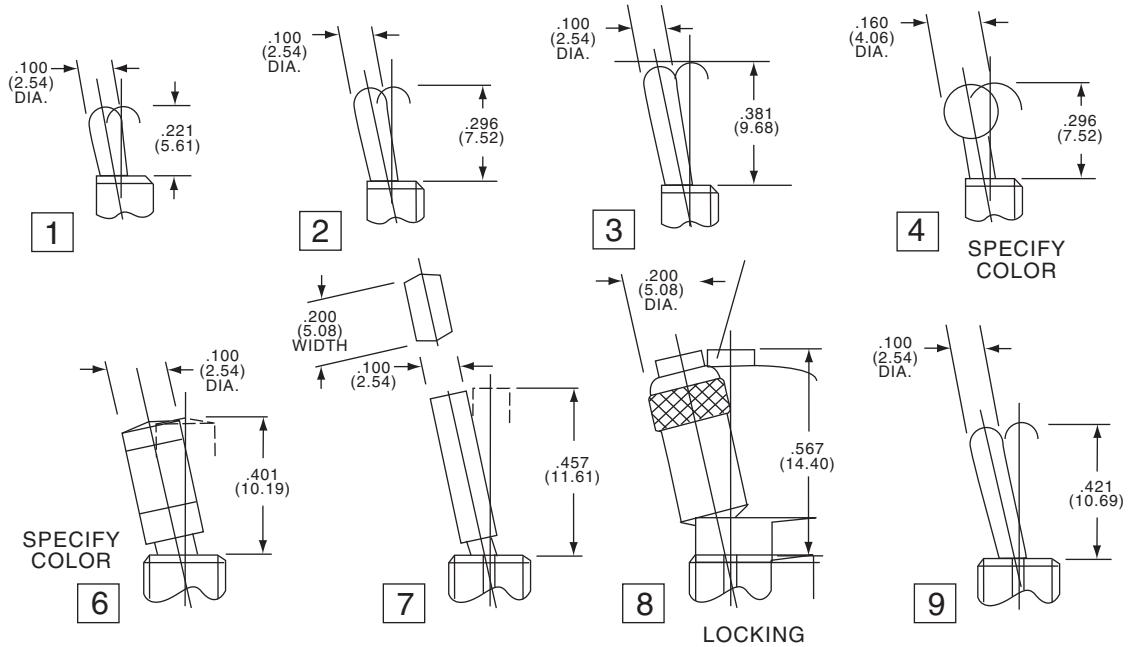

TT Series

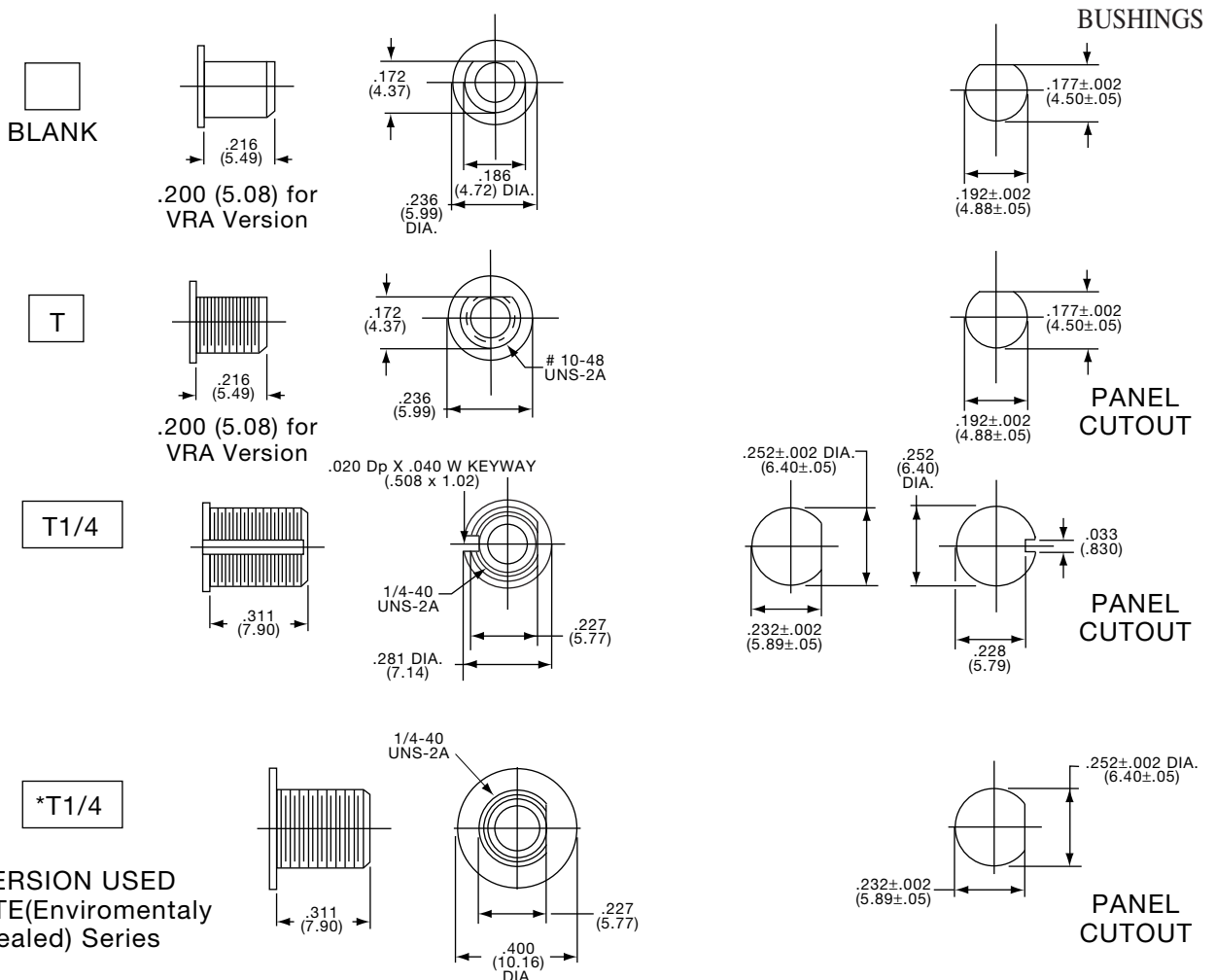

*VERSION USED
ON TTE(Enviromental
Sealed) Series

Toggle Switches, Tiny, Vertical, PC Mount

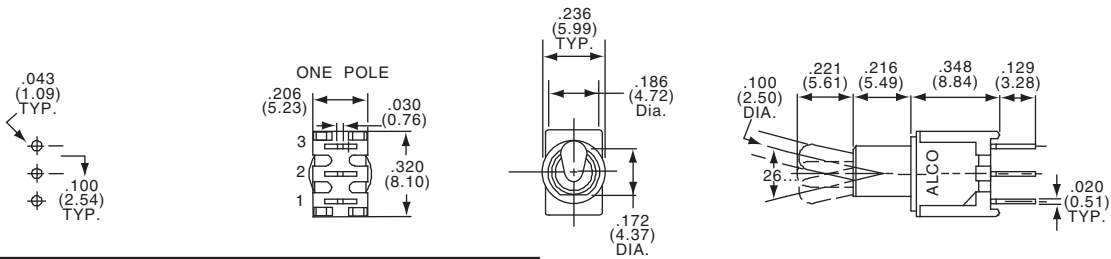

1 POLE
For Terminal Connections refer to Code Chart (see page M5-6)



TT11DGPC1

Tyco Electronics	Alcoswitch	Type	Act. Code	P.	M5	↖	↓	↗
2-1437561-3	TT11AGPC1	SPST	A	On	None	Off		
2-1437561-6	TT11DGPC1	SPDT	D	On	None	On		
5-1437561-1	TT11EGPC1	SPDT	E	On	Off	On		

Note: No center terminal on "A" switches

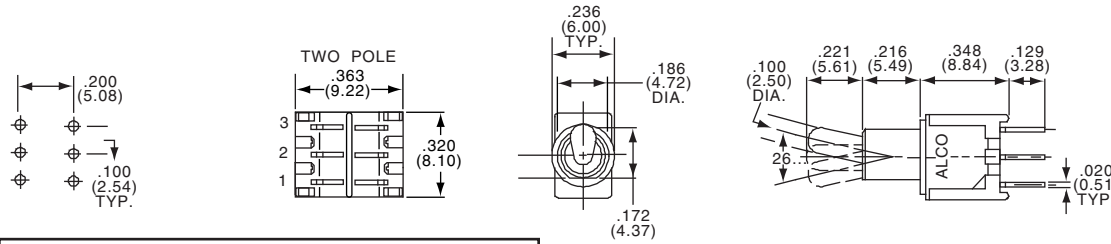

2 POLE
For Terminal Connections refer to Code Chart (see page M5-6)



TT21NGPC1

Tyco Electronics	Alcoswitch	Type	Act. Code	P.	M5	↖	↓	↗
9-1437561-9	TT21KGPC1	DPST	K	On	None	Off		
1437562-3	TT21NGPC1	DPDT	N	On	None	On		
3-1437562-4	TT21PGPC1	DPDT	P	On	Off	On		

Note: No center terminal on "K" switches

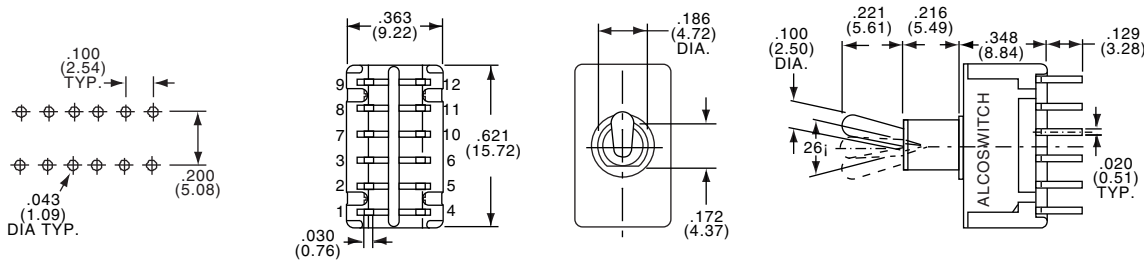

4 POLE

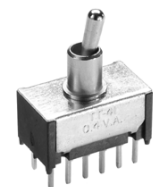

TT41NGPC1

Tyco Electronics	Alcoswitch	Type	Act. Code	P.	M5	↖	↓	↗
6-1437562-6	TT41NGPC1	4PDT	N	On	None	On		

Toggle Switches, Tiny, Vertical and Vertical Right Angle, PC Mount

SEE PAGE C8 FOR PRODUCT SPECIFICATIONS

For terminal connections refer to Code Chart on page M5-6

1 & 2 POLE

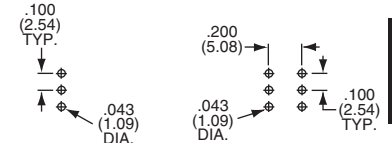
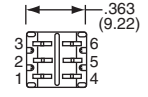
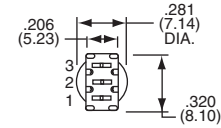
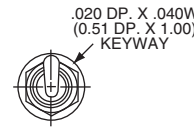
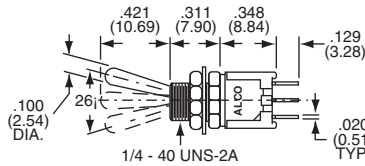
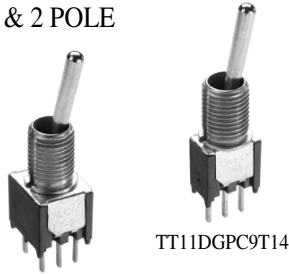

TT21NGPC9T1/4

TT1DGPC9T1/4

4 POLE

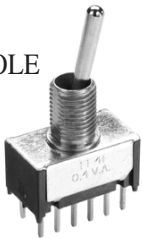

TT41NGPC9T1/4

Tyco Electronics	Alcoswitch	Type	Act.	Code	P.	M5	Tyco Electronics	Alcoswitch	Type	Act.	Code	P.	M5
2-1437561-5	TT11AGPC9T1/4	SPST	A	On	None	Off	1-1437562-1	TT21NGPC9T1/4	DPDT	N	On	None	On
3-1437561-5	TT11DGPC9T1/4	SPDT	D	On	None	On	3-1437562-8	TT21PGPC9T1/4	DPDT	P	On	Off	On
5-1437561-9	TT11EGPC9T1/4	SPDT	E	On	Off	On	4-1437562-6	TT21RGPC9T1/4	DPDT	R	On	None	(On)
7-1437561-3	TT11FGPC9T1/4	SPDT	F	On	None	On	6-1437562-8	TT41NGPC9T1/4	4PDT	N	On	None	On
1437562-1	TT21KGPC9T1/4	DPST	K	On	None	Off	7-1437562-5	TT41PGPC9T1/4	4PDT	P	On	Off	On

Note: No center terminal on "A" or "K" switches.

(On) indicates momentary position.

Note: Hardware Included

1 & 2 POLE



TT1DGVRA1
Vertical Actuation

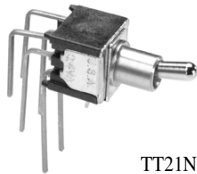

TT21NGVRA1
Vertical Actuation

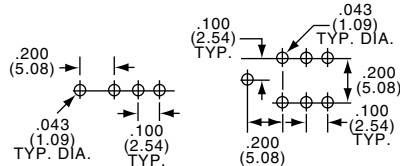
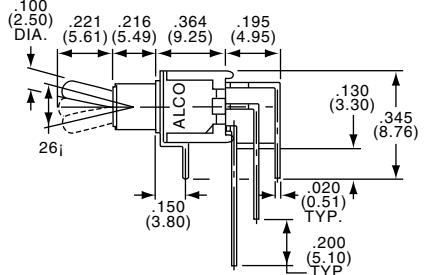
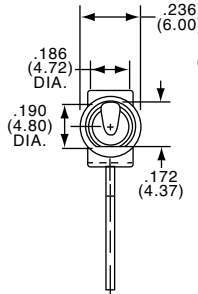
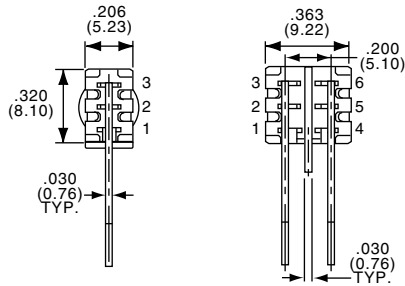

Tyco Electronics	Alcoswitch	Type	Act.	Code	P.	M5
4-1437561-8	TT11DGVRA1	SPDT	D	On	None	On
6-1437561-9	TT11EGVRA1	SPDT	E	On	Off	On
2-1437562-2	TT21NGVRA1	DPDT	N	On	None	On
4-1437562-3	TT21PGVRA1	DPDT	P	On	Off	On

1 & 2 POLE

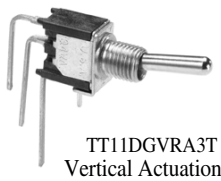

TT1DGVRA3T
Vertical Actuation

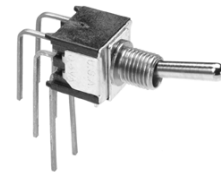

TT21NGVRA3T
Vertical Actuation

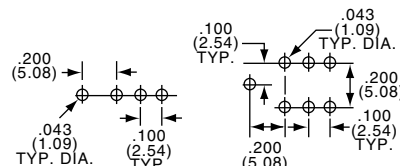
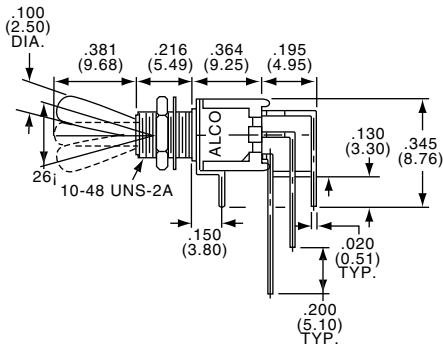
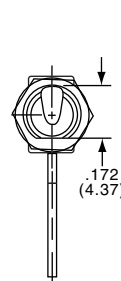
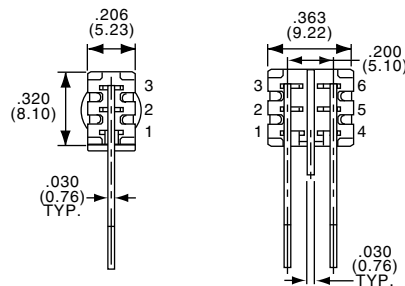

Tyco Electronics	Alcoswitch	Type	Act.	Code	P.	M5
4-1437561-9	TT11DGVRA3T	SPDT	D	On	None	On
7-1437561-0	TT11EGVRA3T	SPDT	E	On	Off	On
2-1437562-3	TT21NGVRA3T	DPDT	N	On	None	On

Toggle Switches, Tiny, Right Angle, Flat Actuator

SEE PAGE C8 FOR PRODUCT SPECIFICATIONS

* Refer to Page C8 for Other Options *

1 & 2 POLE FLAT

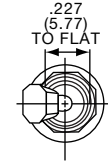
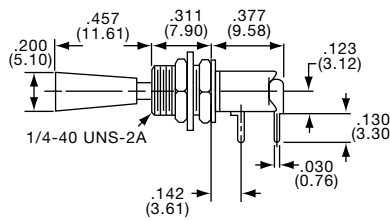
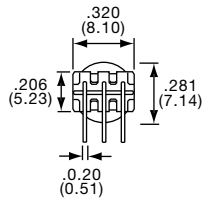
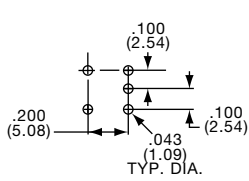

TT11DGRA7T1/4
Horizontal Actuation

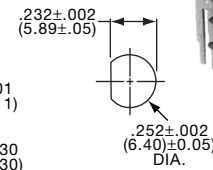
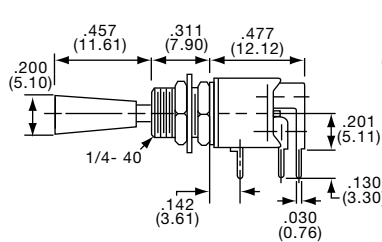
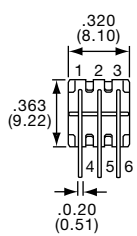
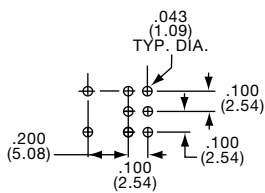

TT21NGRA7T1/4
Horizontal Actuation

Tyco Electronics	Alcoswitch	Type	Act. Code	P. M5	↘	↓	↙
4-1437561-5	TT11DGRA7T1/4	SPDT	D		On	None	On
6-1437561-7	TT11EGRA7T1/4	SPDT	E		On	Off	On
7-1437561-4	TT11FGRA7T1/4	SPDT	F		On	None	(On)
1-1437562-9	TT21NGRA7T1/4	DPDT	N		On	None	On
4-1437562-0	TT21PGRA7T1/4	DPDT	P		On	Off	On

(On) indicates momentary position

Pinned for Anti-Rotation

4 POLE FLAT

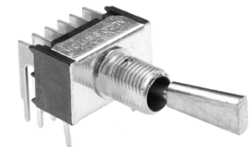
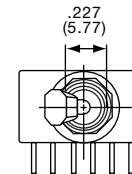
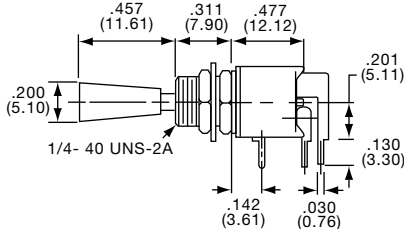
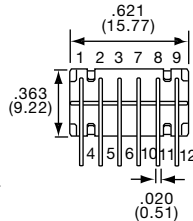
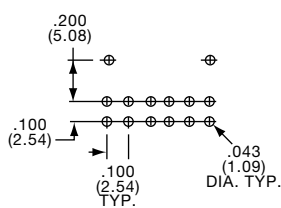

TT41NGRA7T14
Horizontal Actuation

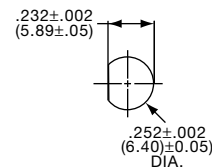

Tyco Electronics	Alcoswitch	Type	Act. Code	P. M5	↘	↓	↙
7-1437562-2	TT41NGRA7T1/4	4PDT	N		On	None	On

Pinned for Anti-Rotation

Toggle Switches, Tiny, Wire Wrap Termination

SEE PAGE C8 FOR PRODUCT SPECIFICATIONS

For terminal connections refer to Code Chart on page M5-6

1 POLE



TT11DGWW2T

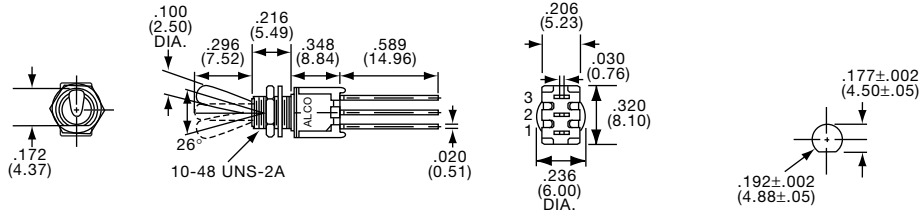

Tyco Electronics	Alcoswitch	Type	Act. Code P. M5	
5-1437561-0	TT11DGWW2T	SPDT	D	On None On
7-1437561-1	TT11EGWW2T	SPDT	E	On Off On

2 POLE



TT21NGWW2T

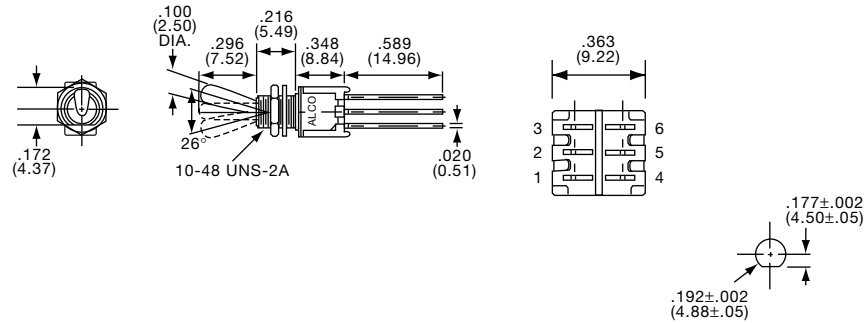

Tyco Electronics	Alcoswitch	Type	Act. Code P. M5	
2-1437562-4	TT21NGWW2T	DPDT	N	On None On
4-1437562-4	TT21PGWW2T	DPDT	P	On Off On

4 POLE

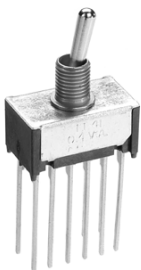

TT41NGWW2T

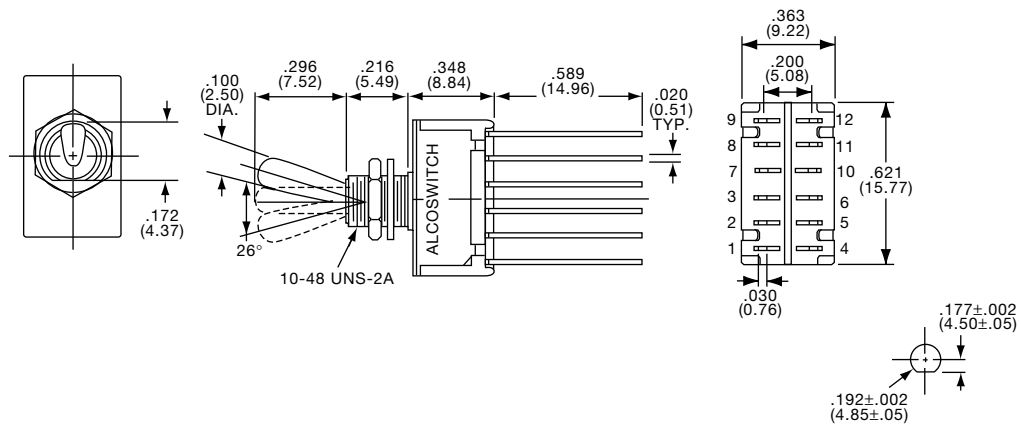

Tyco Electronics	Alcoswitch	Type	Act. Code P. M5	
7-1437562-4	TT41NGWW2T	4PDT	N	On None On

Toggle Switches, Tiny, Wire Lug, Round or Flat Actuators

SEE PAGE C8 FOR PRODUCT SPECIFICATIONS

For terminal connections refer to Code Chart on page M5-6

NOTICE: Wire lug terminals accept two No. 20 AWG wires.

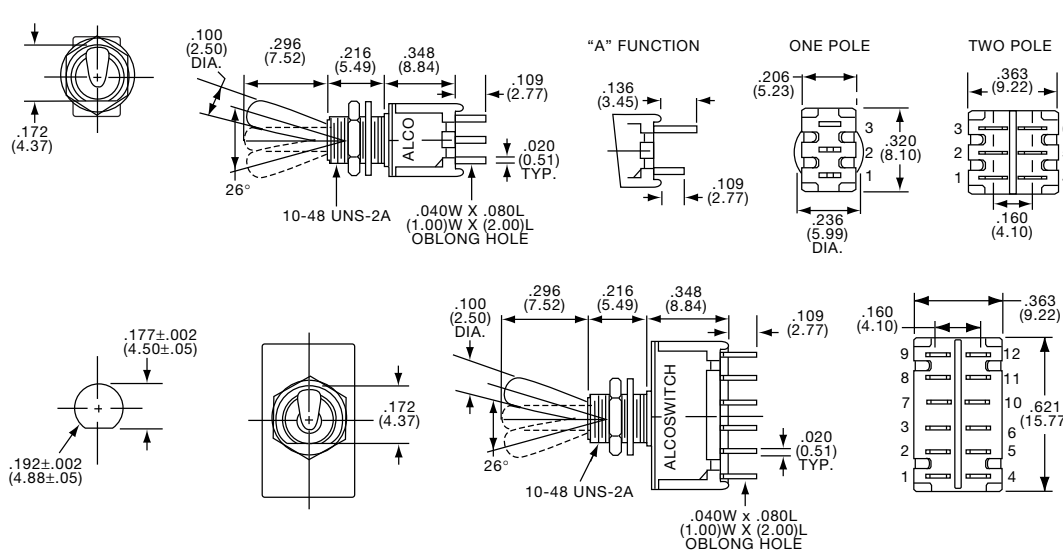

1 & 2 POLE



4 POLE

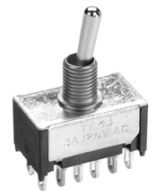

TT43N2T

Tyco Electronics	Alcoswitch	Type	Act. Code P. M5	On	None	Off	Tyco Electronics	Alcoswitch	Type	Act. Code P. M5	On	None	Off
7-1437561-8	TT13A2T	SPST	A	On	None	Off	5-1437562-1	TT23N2T	DPDT	N	On	None	On
8-1437561-5	TT13D2T	SPDT	D	On	None	On	5-1437562-7	TT23P2T	DPDT	P	On	Off	On
9-1437561-5	TT13E2T	SPDT	E	On	Off	On	7-1437562-6	TT43N2T	4PDT	N	On	None	On
4-1437562-7	TT23K2T	DPST	K	On	None	Off							

Note: No center terminal "A" or "K" action switches.

1 & 2 POLE

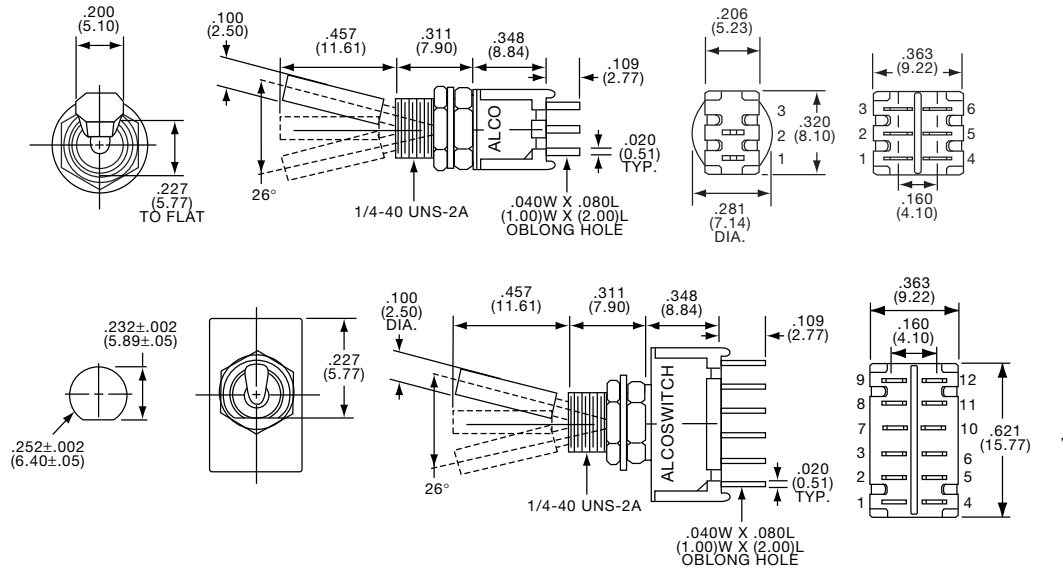

1 & 2 POLE



4 POLE



TT43N7T1/4

Pinned for Anti-Rotation

Tyco Electronics	Alcoswitch	Type	Act. Code P. M5	On	None	Off	Tyco Electronics	Alcoswitch	Type	Act. Code P. M5	On	None	Off
9-1437561-1	TT13D7T1/4	SPDT	D	On	None	On	6-1437562-0	TT23P7T1/4	DPDT	P	On	Off	On
9-1437561-7	TT13E7T1/4	SPDT	E	On	Off	On	7-1437562-8	TT43N7T1/4	4PDT	N	On	None	On
5-1437562-5	TT23N7T1/4	DPST	N	On	None	On		TT43P7T1/4	4PDT	P	On	Off	On

Toggle Switches, Tiny, Wire Lug, Long Actuators

SEE PAGE C8 FOR PRODUCT SPECIFICATIONS

For terminal connections refer to Code Chart on page M5-6

1 & 2 POLE



TT13D3T



TT23N3T

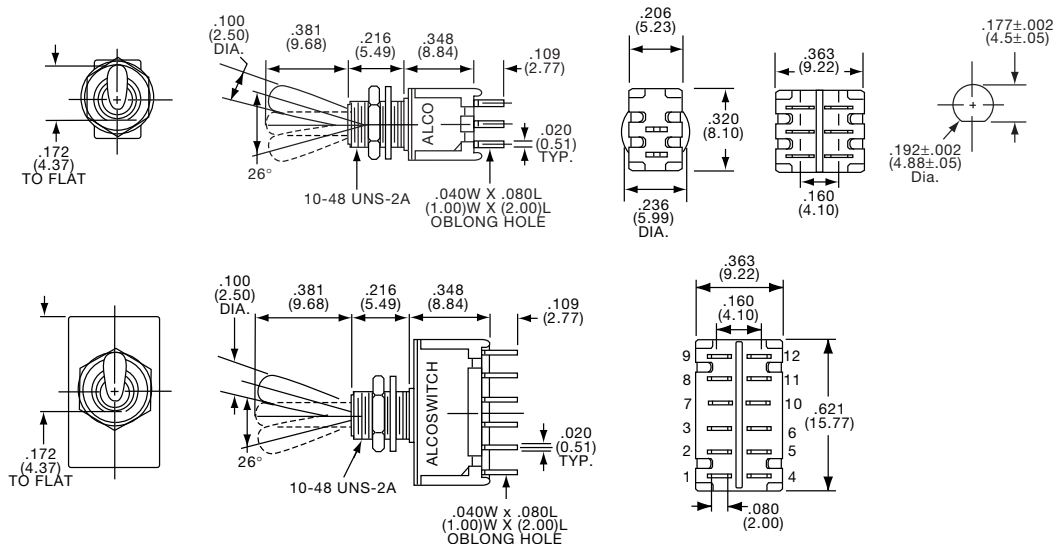

Tyco Electronics	Alcoswitch	Type	Act. Code	P. M5	On	None	Off	Tyco Electronics	Alcoswitch	Type	Act. Code	P. M5	On	None	Off
8-1437561-0	TT13A3T	SPST	A		On	None	Off	5-1437562-8	TT23P3T	DPDT	P		On	Off	On
8-1437561-8	TT13D3T	SPDT	D		On	None	On	7-1437562-7	TT43N3T	4PDT	N		On	None	On
9-1437561-6	TT13E3T	SPDT	E		On	Off	On	8-1437562-0	TT43P3T	4PDT	P		On	Off	On
4-1437562-8	TT23K3T	DPST	K		On	None	Off								
5-1437562-2	TT23N3T	DPDT	N		On	None	On								

Note: No center terminal on "A" or "K" action switches.

1 & 2 POLE



TT13A9T1/4



TT23N9T1/4

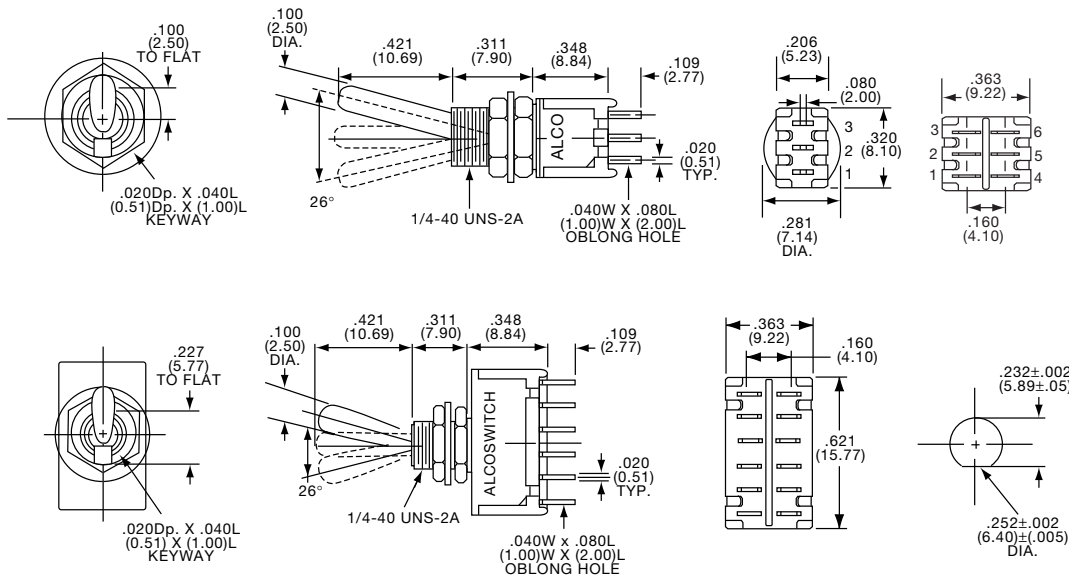

Tyco Electronics	Alcoswitch	Type	Act. Code	P. M5	On	None	Off	Tyco Electronics	Alcoswitch	Type	Act. Code	P. M5	On	None	Off
8-1437561-4	TT13A9T1/4	SPST	A		On	None	Off	6-1437562-2	TT23P9T1/4	DPDT	P		On	Off	On
9-1437561-2	TT13D9T1/4	SPDT	D		On	None	On	7-1437562-9	TT43N9T1/4	4PDT	N		On	None	On
9-1437561-8	TT13E9T1/4	SPDT	E		On	Off	On	8-1437562-1	TT43P9T1/4	4PDT	P		On	Off	On
4-1437562-9	TT23K9T1/4	DPST	K		On	None	Off								
5-1437562-6	TT23N9T1/4	DPDT	N		On	None	On								

Note: No center terminal on "A" or "K" action switches.

4 POLE



TT43N9T1/4

Toggle Switches, Process Sealed, Vertical

MATERIAL SPECIFICATIONS:

ContactsGold over nickel
 Inner Case MaterialHigh temperature polyester
 Outer Case MaterialPolyamide
 Terminals/Fixed ContactsTin lead plate
 Terminal SealEpoxy
 Process SealDisposable boot, epoxied double case

TYPICAL PERFORMANCE CHARACTERISTICS:

Contact Rating0.4VA Max. @ 20 VDC or peak AC
 Initial Contact Resistance.....20 Milliohms max.
 Contact Timing.....Break-before-make
 Insulation Resistance1,000 Megohms min. 500 VDC
 Dielectric Strength1,000 Volts RMS @ sea level
 Plunger/Actuator Travel......26°
 Life ExpectancySee page C8

ENVIRONMENTAL SPECIFICATIONS

Operating Temperature-22°F to +185°F (-30°C to +85°C)
 Storage Temperature-67°F to +185°F (-55°C to +85°C)
 Solder Heat Resistance.....See page M3-4

APPLICATION NOTE: Each switch is provided with a disposable boot used only during cleaning operation.

*** Refer to Page C8 for Other Options ***

Note: Hardware included with switch

TT-ES Series

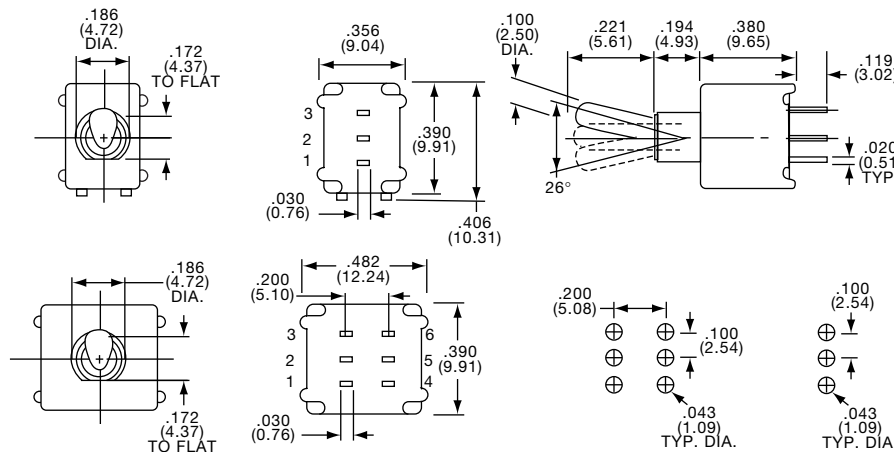

1 & 2 POLE UNTHREADED BUSHING



TT11DGPC1ES

Tyco Electronics	Alcoswitch	Type	Act. Code P. M5	On	None	Off	Tyco Electronics	Alcoswitch	Type	Act. Code P. M5	On	None	On
2-1437561-4	TT11AGPC1ES	SPST	A	On	None	Off	1437562-4	TT21NGPC1ES	DPDT	N	On	None	On
2-1437561-7	TT11DGPC1ES	SPDT	D	On	None	On							

Note: No center terminal "A".

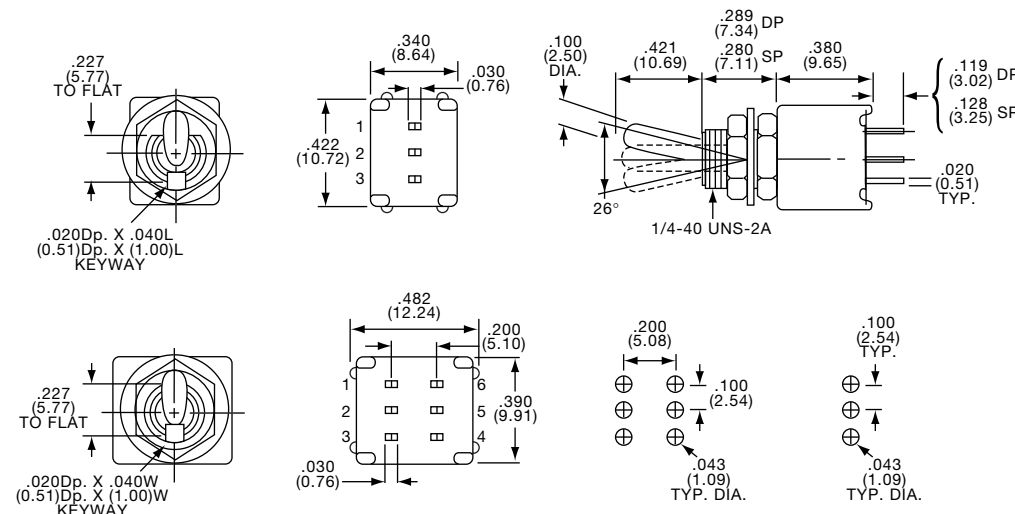

1 & 2 POLE THREADED BUSHING

TT11DGPC9T1/4ES



TT21NGPC9T1/4ES



Tyco Electronics	Alcoswitch	Type	Act. Code P. M5	On	None	Off	Tyco Electronics	Alcoswitch	Type	Act. Code P. M5	On	None	On
	TT11AGPC9T1/4ES	SPST	A	On	None	Off	1-1437562-2	TT21NGPC9T1/4ES	DPDT	N	On	None	On
6-1437830-2	TT11DGPC9T1/4ES	SPDT	D	On	None	On		TT21PGPC9T1/4ES	DPDT	P	On	Off	On
	TT11EGPC9T1/4ES	SPDT	E	On	Off	(On)							
	TT21KGPC9T1/4ES	DPST	K	On	None	Off							

Note: No center terminal "A" or "K" action switches.
 (On) indicates momentary position.

Toggle Switches, Tiny, Enviromental and Process Sealed

SEE PAGE C16 FOR PRODUCT SPECIFICATIONS

For terminal connections refer to Code Chart on page M5-6

1 POLE-PC VERTICAL MOUNT

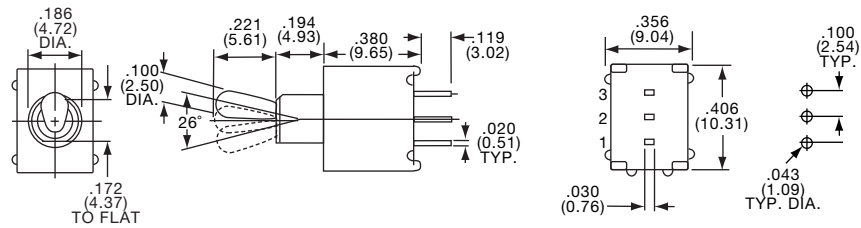

Tyco Electronics	Alcoswitch	Type	Act. Code P. M5			
8-1437562-6	TTE11DGPC1ES	SPDT	D	On	None	On
	TTE11EGPC1ES	SPDT	E	On	Off	On

2 POLE-PC VERTICAL MOUNT

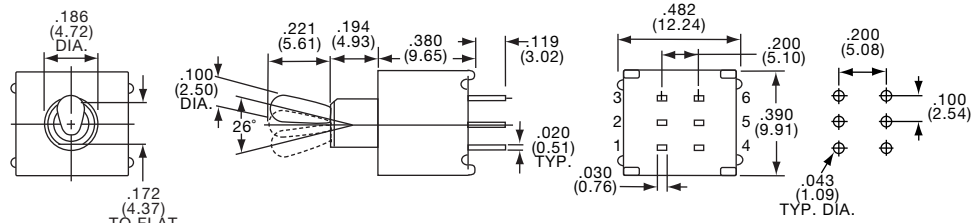

Tyco Electronics	Alcoswitch	Type	Act. Code P. M5			
1437563-1	TTE21NGPC1ES	DPDT	N	On	None	On
	TTE21PGPC1ES	DPDT	P	On	Off	On

1 POLE-PC RIGHT ANGLE



TTE11DGRA1ES
Horizontal Actuation

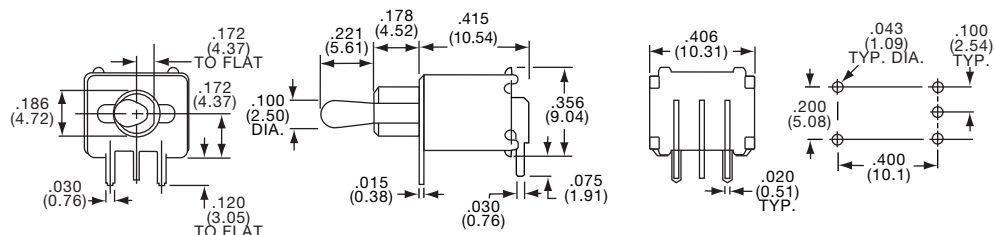

Tyco Electronics	Alcoswitch	Type	Act. Code P. M5			
8-1437562-9	TTE11DGRA1ES	SPDT	D	On	None	On
9-1437562-2	TTE11EGRA1ES	SPDT	E	On	Off	On

2 POLE-PC RIGHT ANGLE



TTE21NGRA1ES
Horizontal Actuation

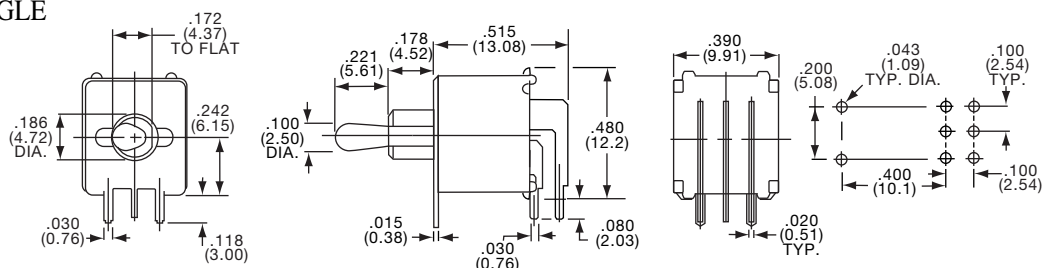

Tyco Electronics	Alcoswitch	Type	Act. Code P. M5			
1437563-4	TTE21NGRA1ES	DPDT	N	On	None	On
	TTE21PGRA1ES	DPDT	P	On	Off	On

Toggle Switches, Tiny, Enviromental and Process Sealed

For terminal connections refer to Code Chart on page M5-6.

SEE PAGE C16 FOR PRODUCT SPECIFICATIONS

* Refer to Page C8 for Other Options *

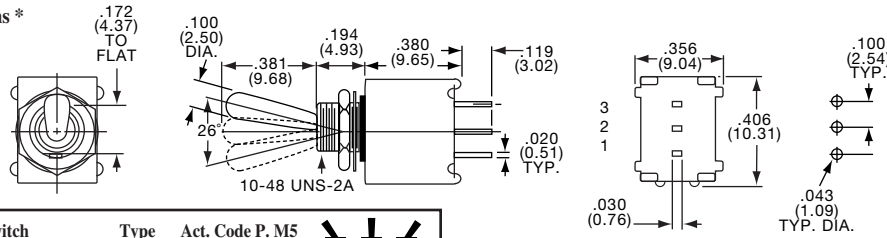

1 POLE



TTE11DGPC3TES

Tyco Electronics	Alcoswitch	Type	Act. Code	P. M5	On	None	Off
8-1437562-5	TTE11AGPC3TES	SPST	A		On	None	Off
8-1437562-7	TTE11DGPC3TES	SPDT	D		On	None	On
9-1437562-0	TTE11EGPC3TES	SPDT	E		On	Off	On

Note: No center terminal on "A" action switches.

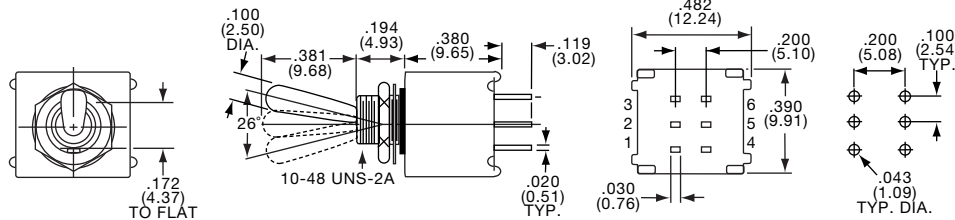

2 POLE



TTE21NGPC3TES

Tyco Electronics	Alcoswitch	Type	Act. Code	P. M5	On	None	On
1437563-2	TTE21NGPC3TES	DPDT	N		On	None	On
	TTE21PGPC3TES	DPDT	P		On	Off	On

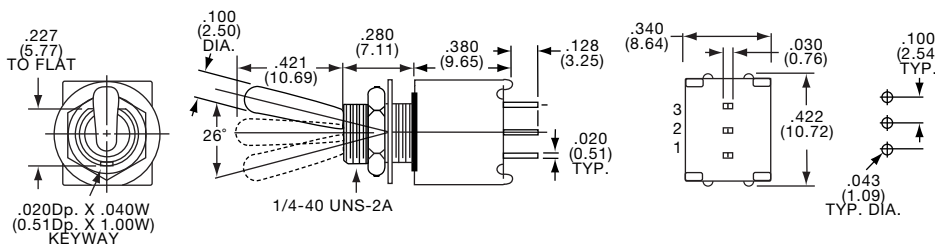

1 POLE



TTE11DGPC9T4ES

Tyco Electronics	Alcoswitch	Type	Act. Code	P. M5	On	None	Off
	TTE11AGPC9T1/4ES	SPST	A		On	None	Off
8-1437562-8	TTE11DGPC9T1/4ES	SPDT	D		On	None	On
9-1437562-1	TTE11EGPC9T1/4ES	SPDT	E		On	Off	On

Note: No center terminal on "A" action switches.

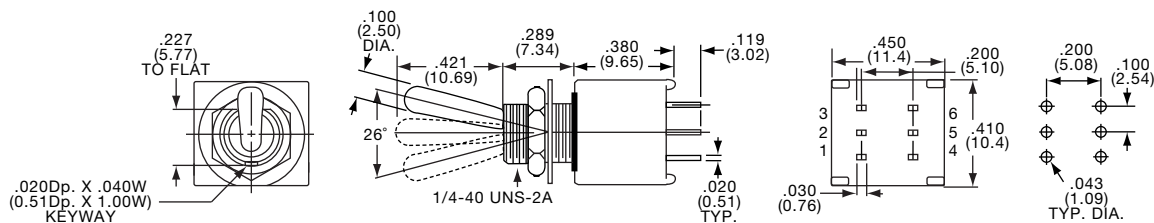

2 POLE



TTE21NGPC9T4ES

Tyco Electronics	Alcoswitch	Type	Act. Code	P. M5	On	None	Off
	TTE21KGPC9T1/4ES	DPST	K		On	None	Off
1437563-3	TTE21NGPC9T1/4ES	DPDT	N		On	None	On
	TTE21PGPC9T1/4ES	DPDT	P		On	Off	On

Note: No center terminal on "K" action switches.

Toggle Switches, Process Sealed, Vertical and Right Angle, Round Actuator

MATERIAL SPECIFICATIONS:

ContactsGold over nickel plate
 Case MaterialPolyester 94V-0
 Actuator MaterialNickel plated copper alloy
 TerminalsPhosphor bronze
 Terminal SealEpoxy
 Process SealTested to MIL-STD-202, method 112
 (Internal O-Ring) test condition A and D, 85°C

TYPICAL PERFORMANCE CHARACTERISTICS:

Contact Rating0.4 VA Max. @ 20 VDC
 Initial Contact Resistance100 Milliohms max.
 Contact TimingBreak-before-make
 Insulation Resistance500 Megohms @ 250 VDC min.
 Dielectric Strength500 Volts RMS @ sea level
 Actuation Force400 Grams
 Life ExpectancyUp to 10,000 Cycles

ENVIRONMENTAL SPECIFICATIONS

Operating Temperature.....-4°F to +176°F (-20°C to +80°C)
 Storage Temperature.....-40°F to +176°F (-40°C to +80°C)

4PDT



ATE4DGPC2

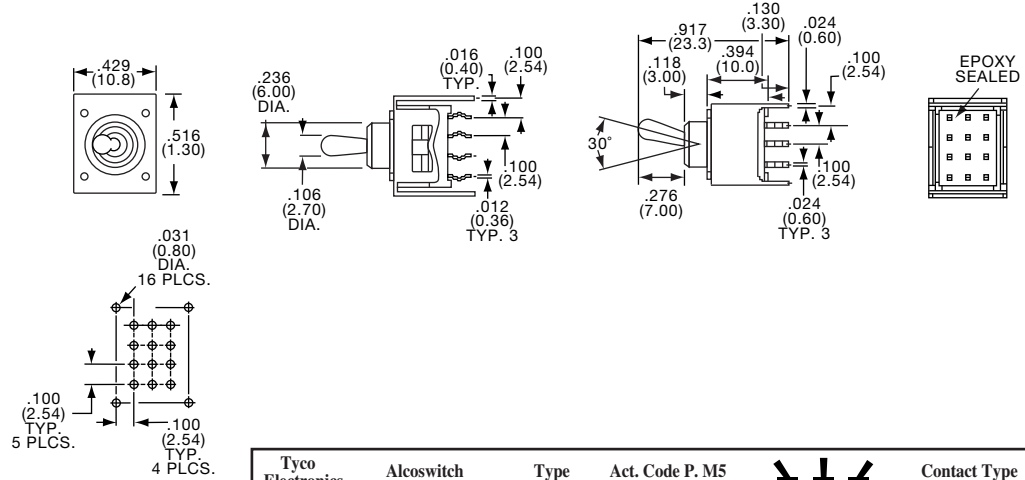

Tyco Electronics	Alcoswitch	Type	Act. Code P. M5		Contact Type
2-1437557-1	ATE4DGPC2	4PDT	8	On None On	Gold

4PDT

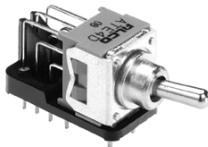

ATE4DGRA2

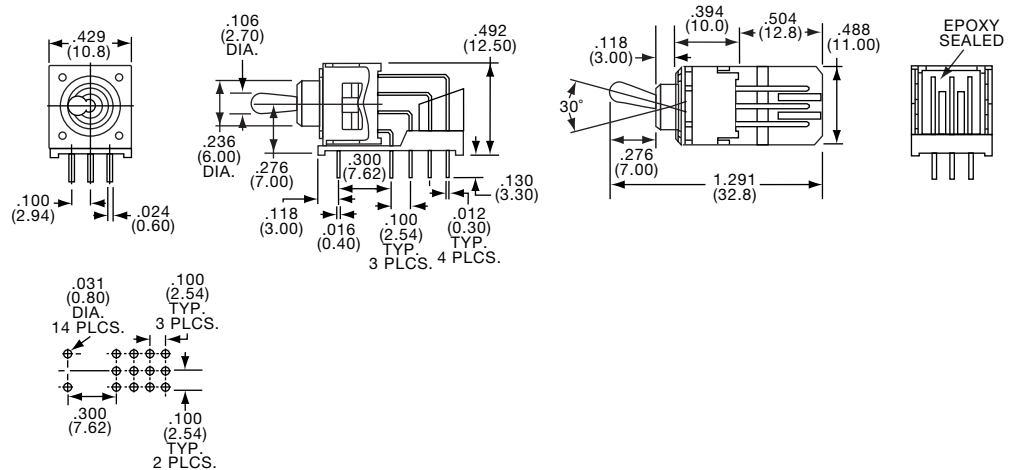

Tyco Electronics	Alcoswitch	Type	Act. Code P. M5		Contact Type
2-1437557-2	ATE4DGRA2	4PDT	8	On None On	Gold

Toggle Switches, Process Sealed, Vertical, Round or Flat Actuators

SEE PAGE C19 FOR PRODUCT SPECIFICATIONS

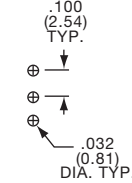
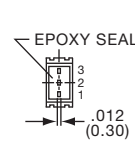
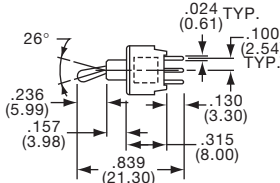
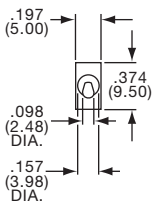

P.C. HOLE LAYOUT SINGLE POLE

SPDT/DPDT



ATE1DGPC1

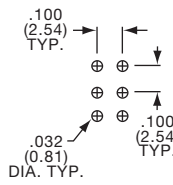
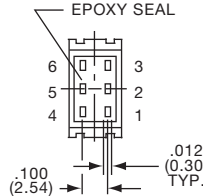
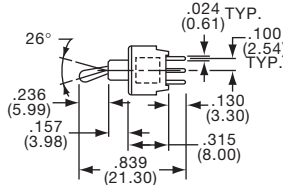
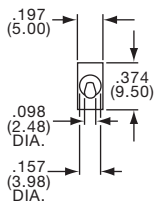

P.C. HOLE LAYOUT DOUBLE POLE

Extra compact double pole saves PCB real estate.



ATE2DGPC1

Tyco Electronics	Alcoswitch	Type				Contact Type	Tyco Electronics	Alcoswitch	Type				Contact Type	
1437557-2	ATE1DGPC1	SPDT	On	None	On	Gold	1-1437557-5	ATE2DGPC1	DPDT	On	None	On	Gold	
1437557-6	ATE1EGPC1	SPDT	On	Off	On	Gold	1-1437557-9	ATE2EGPC1	DPDT	On	Off	On	Gold	
1-1437557-2	ATE1GGPC1	SPDT	On (On)	None (On)	On (On)	Gold	Terminals Connected:							
Terminals Connected:							2-3						2-1	
							5-6						5-4	
(On) indicates momentary position.														

SPDT/DPDT

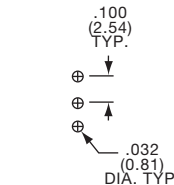
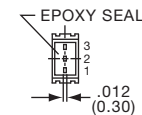
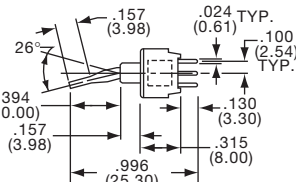
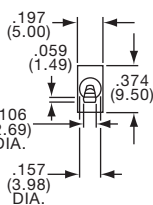

P.C. HOLE LAYOUT SINGLE POLE



ATE1DGPC7

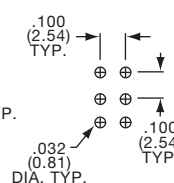
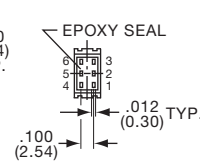
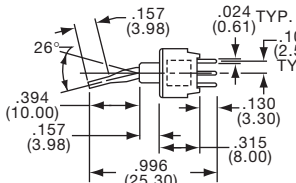
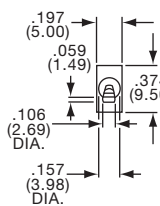

P.C. HOLE LAYOUT DOUBLE POLE

Extra compact double pole saves PCB real estate.



ATE2DGPC7

Tyco Electronics	Alcoswitch	Type				Contact Type	Tyco Electronics	Alcoswitch	Type				Contact Type	
1437557-3	ATE1DGPC7	SPDT	On	None	On	Gold	1-1437557-6	ATE2DGPC7	DPDT	On	None	On	Gold	
1-1437557-3	ATE1GGPC7	SPDT	On (On)	Off (On)	On (On)	Gold	Terminals Connected:							
Terminals Connected:							2-3						2-1	
							5-6						5-4	
(On) indicates momentary position.														

Toggle Switches, Process Sealed, Right Angle, Retention Feature

SEE PAGE C19 FOR PRODUCT SPECIFICATIONS

SPDT/DPDT



ATE1DGRA1
Horizontal Actuation

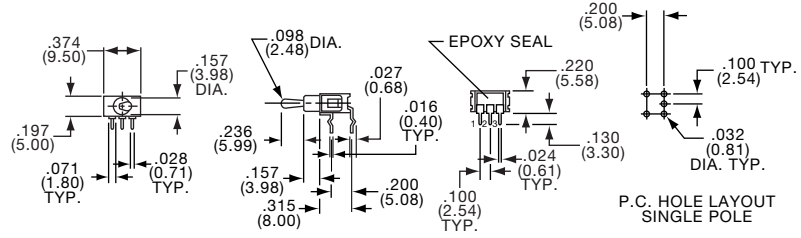

Extra compact double pole saves PCB real estate.



ATE2DGRA1
Horizontal Actuation

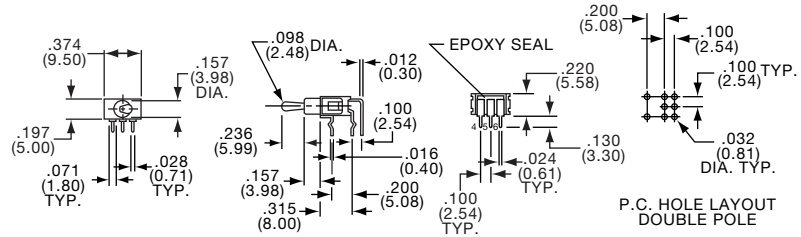

Tyco Electronics	Alcoswitch	Type	On	None	On	Contact Type	Tyco Electronics	Alcoswitch	Type	On	None	On	Contact Type
1437557-4	ATE1DGRA1	SPDT	On	None	On	Gold	1-1437557-7	ATE2DGRA1	DPDT	On	None	On	Gold
1437557-8	ATE1EGRA1	SPDT	On	Off	On	Gold	3-1437592-7	ATE2EGRA1	DPDT	On	Off	On	Gold
1-1437557-0	ATE1FGRA1	SPDT	On	None (On)		Gold		ATE2GGRA1	DPDT	(On)	Off	(On)	Gold
1-1437557-4	ATE1GGRA1	SPDT	(On)	Off	(On)	Gold	Terminals Connected:			2-3		2-1	
Terminals Connected:			2-3		2-1					5-6		5-4	
(On) indicates momentary position.							(On) indicates momentary position.						

SPDT/DPD



ATE1DGRA7
Horizontal Actuation

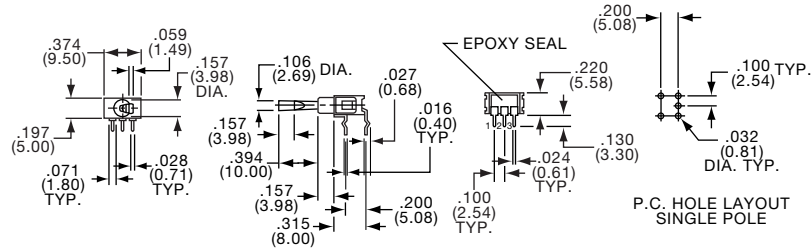

Extra compact double pole saves PCB real estate.



ATE2DGRA7
Horizontal Actuation

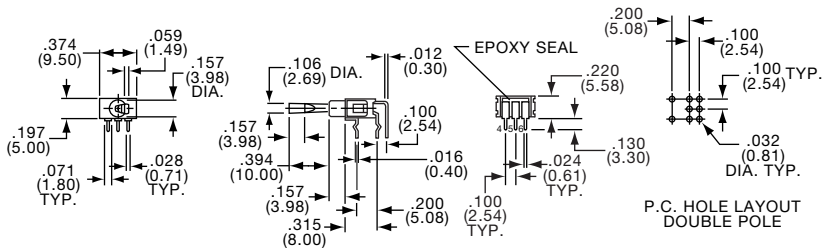

Tyco Electronics	Alcoswitch	Type	On	None	On	Contact Type	Tyco Electronics	Alcoswitch	Type	On	None	On	Contact Type
1437557-5	ATE1DGRA7	SPDT	On	None	On	Gold	1-1437557-8	ATE2DGRA7	DPDT	On	None	On	Gold
1437557-9	ATE1EGRA7	SPDT	On	Off	On	Gold	Terminals Connected:			2-3		2-1	
1-1437557-1	ATE1FGRA7	SPDT	On	None (On)		Gold				5-6		5-4	
Terminals Connected:			2-3		2-1								
(On) indicates momentary position.							(On) indicates momentary position.						