

# S and SF series

## Washable miniature toggle switches

*Distinctive features and specifications*

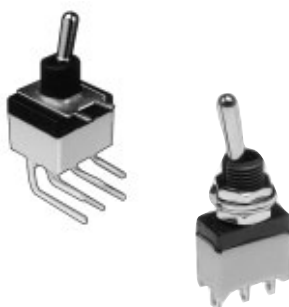

- Sealed**
  - Secure assembly of the two case parts
  - Internally sealed bushing
  - Epoxy sealed terminals
- Process compatible (S series)**
  - Wave solderable
  - Washable
- Optional ESD protection**

### ELECTRICAL SPECIFICATIONS

- Max. current/voltage rating with resistive load :
  - silver contacts (A or 1) : 2A 250VAC - 5A 125VAC - 4A 30VDC
  - gold plated brass contacts (CD or 0) : 0,4VA 20VAC or DC
  - gold plated silver contacts (AD or 2) : 2A 250VAC - 5A 125VAC - 4A 30VDC (300mA 30VDC for gold plating)
- Initial contact resistance : 10 mΩ max.
- Insulation resistance : 1.000 MΩ min.
- Dielectric strength : 1.000 Vrms 50 Hz min.
- Electrical life at full load :

Contacts	Number of cycles	
	2 positions	3 positions
A or 1	40.000	40.000
CD or 0	100.000	50.000
AD or 2	40.000	40.000

### MATERIALS

- Case and cover : UL94-VO, polyamide, glass filled or PES
- Actuator : brass, chrome plated
- Contacts
  - CD or 0 : brass, gold plated
  - A or 1 : silver
  - AD or 2 : silver, gold plated
- Terminal seal : epoxy

### GENERAL SPECIFICATIONS

- Mechanical strength :  
Terminals are strengthened by a bracket or a ground plate ensuring the rigidity of the switch on the board.  
Actuator strength is 10N max.
- Operating temperature : -20°C to +85°C
- Storage temperature : -40°C to +85°C
- Moisture :  
The insulating materials employed and the complete seal permit the switches to withstand a 56 days moisture test (IEC 68-2-3).
- Soldering - thermal shock (S series only) :  
The switches are especially designed for flow soldering at 260°C during 5 seconds owing to high temperature polymer parts.
- Iron soldering (SF series) : 300°C 5 sec. max.
- Solderability : The switches are tested at 235°C according to IEC 68-2-20 after accelerated aging.

### AGENCY APPROVALS



CECC 96201-006

**Availability** : consult factory for details of approved models.

**Marking** : to order switches marked UL or CECC, complete appropriate box of ordering format.

# S series

## Washable toggle switches - plain bushing

### Overview

MODEL  
STRUCTURE

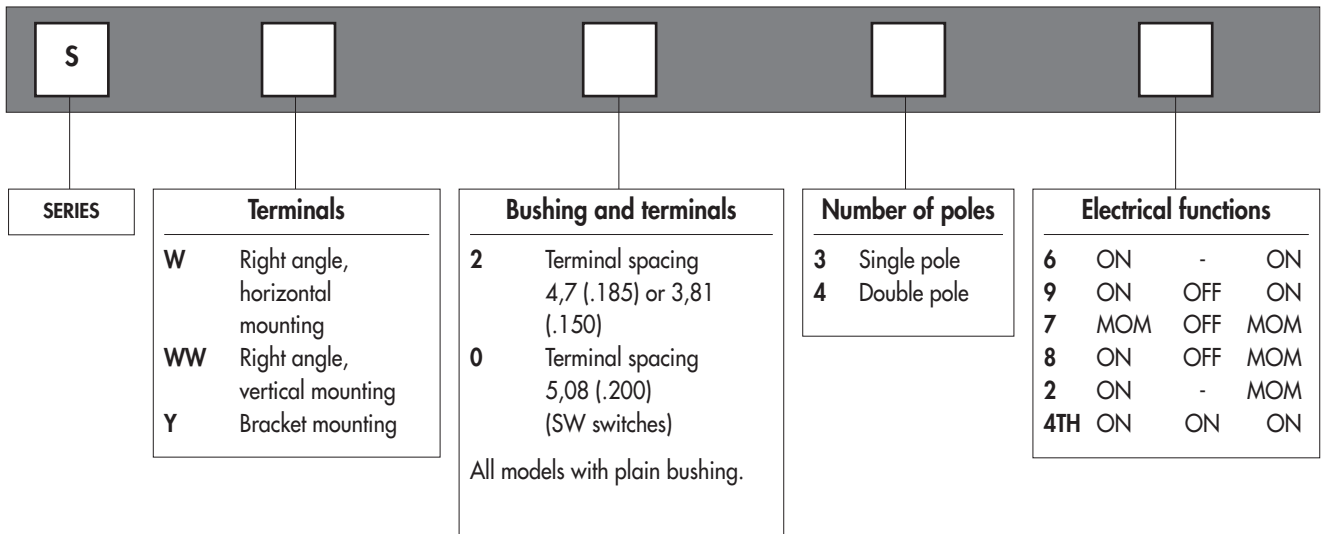

OPTIONS

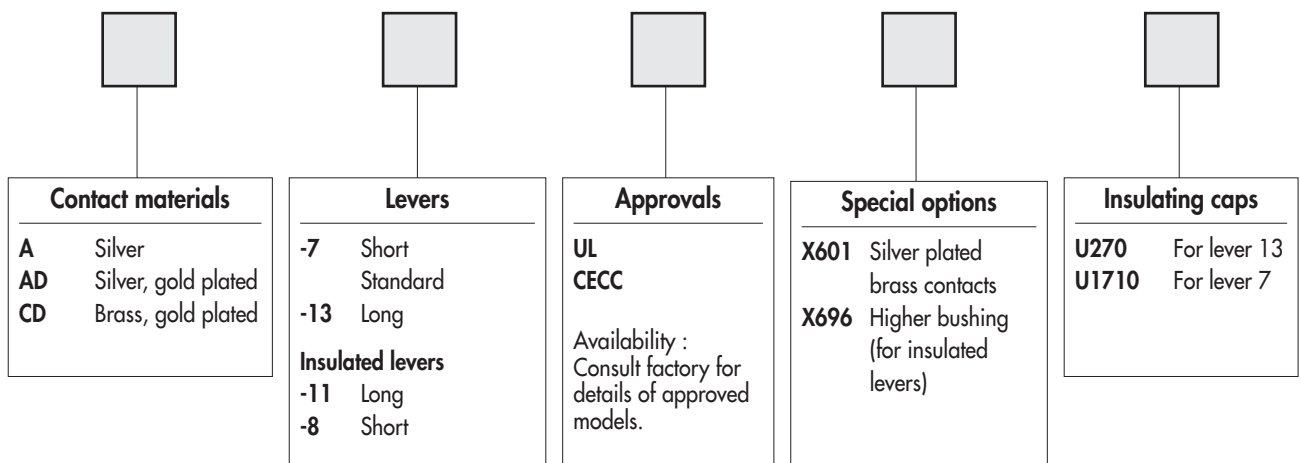

#### ABOUT THIS SERIES

On the following pages, you will find successively :

- model structure of switches
- options in the same order as above

**Dimensions** : first dimensions are in mm while inches are shown as bracketted numbers.



**NOTICE** : please note that not all combinations of above numbers are available. Refer to the following pages for further information.



**Packaging unit** : 50 or 25 pieces depending on model.



# S series

## Washable toggle switches - plain bushing

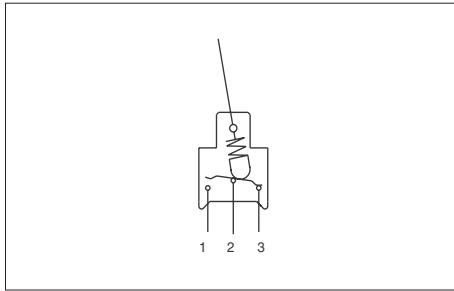

- Straight PC or right angle terminals
- Terminal spacing 4,7 (.185) or 5,08 (.200) on SW switches
- 1 and 2 pole configurations

### MODEL STRUCTURE



Shown with lever (-7)

### Right angle terminals - horizontal - spacing 4,7 (.185)



Single pole Double pole

SW236	SW246
SW239	SW249
SW237	SW247
SW238	SW248
SW232	SW242
	SW244TH*

III	II	I
2-3		2-1
5-6		4-5
ON	-	ON
ON	OFF	ON
MOM	OFF	MOM
ON	OFF	MOM
ON	-	MOM
ON	ON	ON

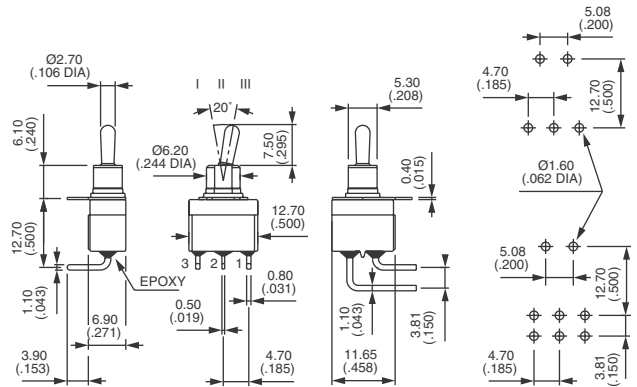

### Right angle terminals - vertical



Single pole Double pole

SWW236	SWW246
SWW239	SWW249
SWW237	SWW247
SWW238	SWW248**
SWW232	SWW242**
	SWW244TH*

I	II	III
2-3		2-1
5-6		4-5
ON	-	ON
ON	OFF	ON
MOM	OFF	MOM
ON	OFF	MOM
ON	-	MOM
ON	ON	ON

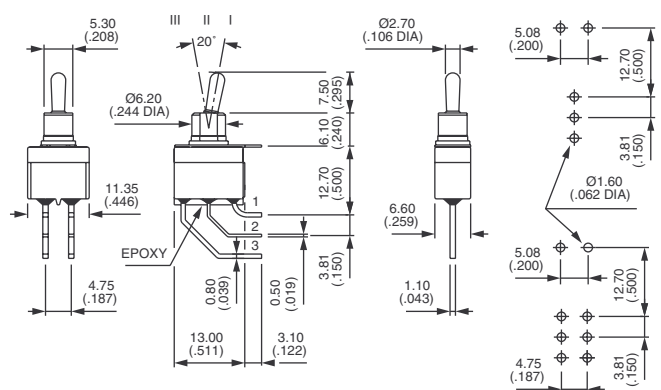

### Bracket mounting



Single pole Double pole

SY236	SY246
SY239	SY249
SY237	SY247
SY238	SY248
SY232	SY242
	SY244TH*

III	II	I
2-3		2-1
5-6		4-5
ON	-	ON
ON	OFF	ON
MOM	OFF	MOM
ON	OFF	MOM
ON	-	MOM
ON	ON	ON

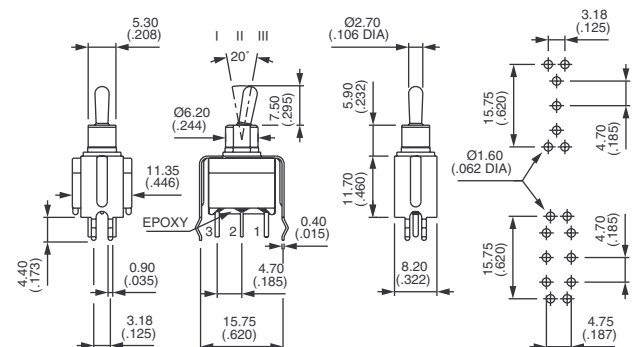

\* Function 4 : SP in DP case - TH connection, see end of catalogue.

\*\* Functions 2 and 8 : reversed connection available. Consult factory.

# S series

Washable toggle switches - plain bushing

MODEL  
STRUCTURE

## Right angle terminals - horizontal - spacing 5,08 (.200)



Single pole Double pole

SW036	SW046
SW039	SW049
SW037	SW047
SW038	SW048
SW032	SW042
	SW044TH*

III	II	I
2-3		2-1
5-6		4-5
ON	-	ON
ON	OFF	ON
MOM	OFF	MOM
ON	OFF	MOM
ON	-	MOM
ON	ON	ON

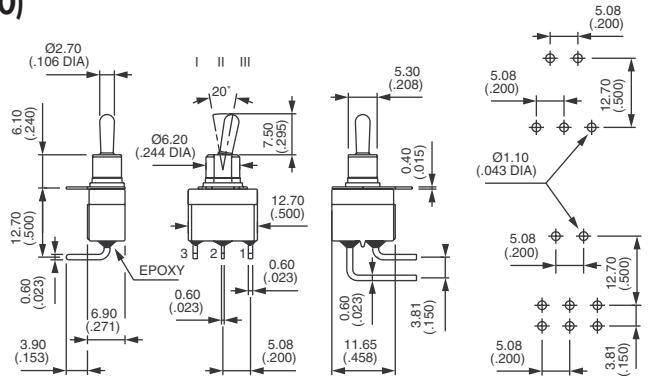

\* Function 4 : SP in DP case, see end of catalogue.

## PCB MOUNTING

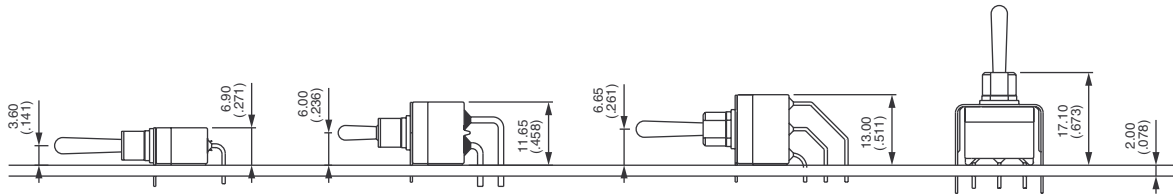

## CAP FOR PCB PROCESSING

Provide additional protection during PCB processing.  
Supplied mounted on the switch or separately.  
Material : vinyl

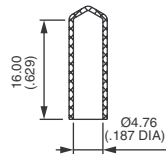

U3012



# S series

## Washable toggle switches - plain bushing

### CONTACT MATERIALS

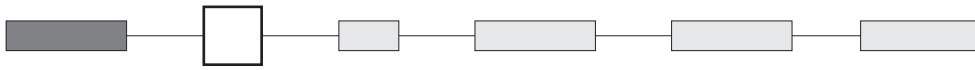

- A Silver
- AD Silver, gold plated
- CD Brass, gold plated

### LEVERS

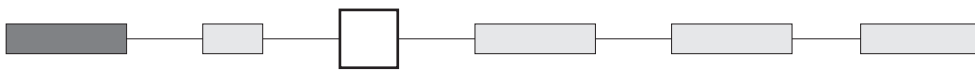

Dash compulsory before lever code.

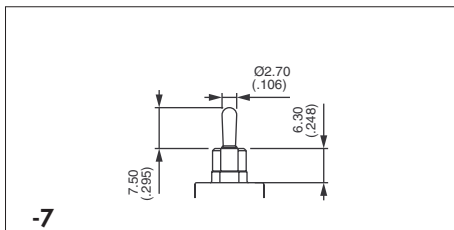

**-7**  
Standard

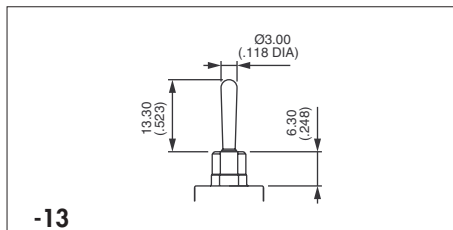

**-13**  
Long



If actuator not specified, we supply former default option -13.

### Insulated levers

Protected against electrostatic discharges (ESD) up to 12 KV. Black colour.

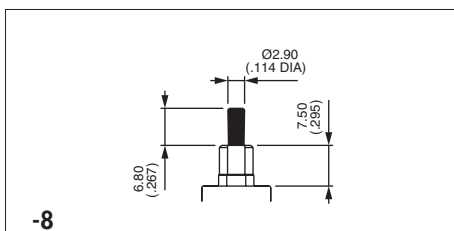

**-8**  
Short

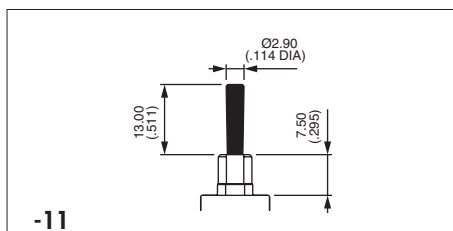

**-11**  
Long



To combine with option X696.

### SPECIAL OPTIONS



**X601** Silver plated brass contacts  
Lower rating - Minimum quantity : 5.000 pieces per model and shipment.

**X696** Higher bushing 7,50 (.295). Compulsory for insulated levers 11 and 8.

# S series

Washable toggle switches - plain bushing



## AGENCY APPROVALS

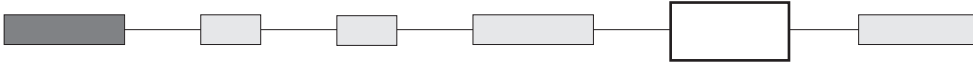

UL  
CECC

**Availability** : consult factory for details of approved models.

**Marking** : to order switches marked UL or CECC, please complete above box with desired approvals.  
Blank : no agency approval required.

## INSULATING CAPS

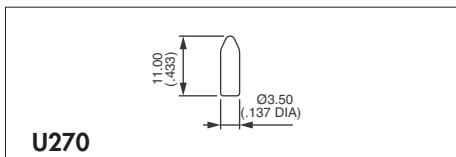
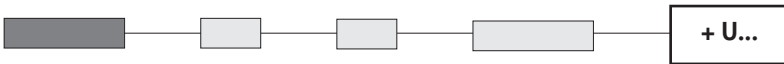

**U270**

For lever 13

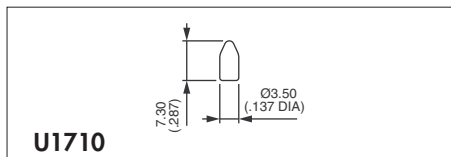

**U1710**

For lever 7

### Cap colours

Replace "0" by number

- |     |           |
|-----|-----------|
| 1   | blue      |
| 1/4 | dark blue |
| 2   | black     |
| 3   | green     |
| 4   | grey      |
| 5   | yellow    |
| 6   | red       |
| 7/1 | white     |
| 9   | orange    |

# SF series

## Washable toggle switches - insulated threaded bushing

Overview

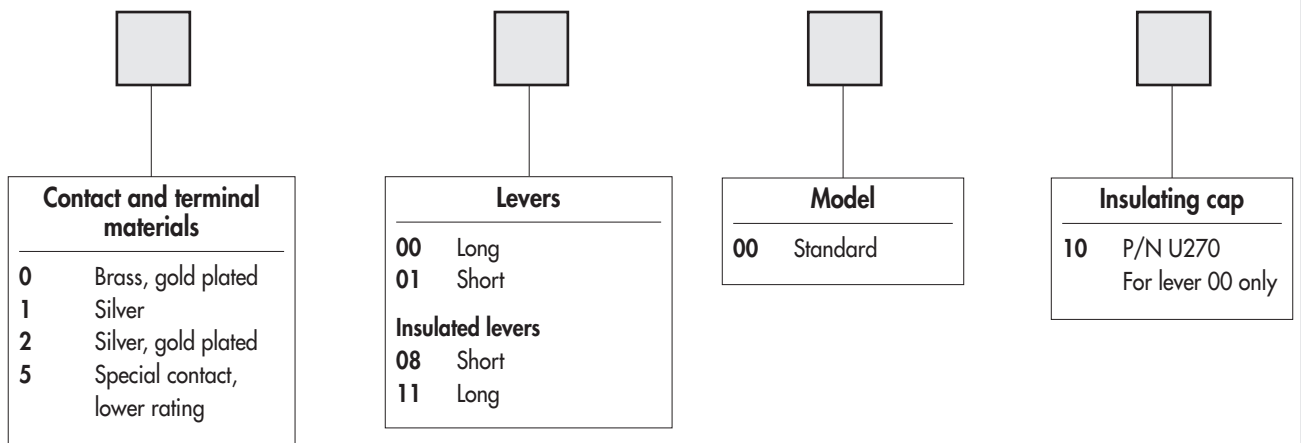
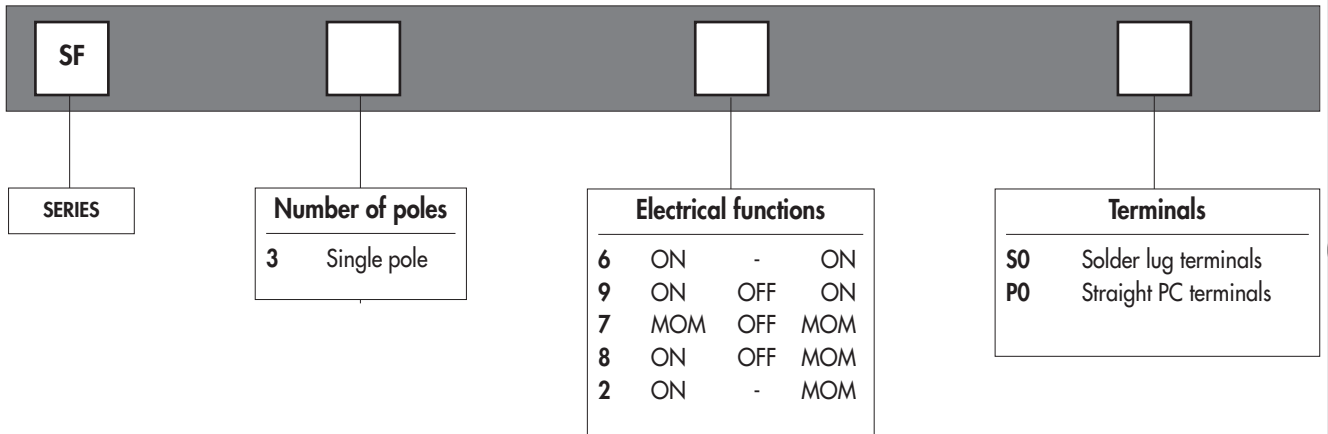

### ABOUT THIS SERIES

On the following pages, you will find successively :

- model structure of switches

- options in the same order as above

Specifications are at the beginning of the S series.

**Dimensions** : first dimensions are in mm while inches are shown as bracketted numbers.



**Mounting accessories** : 2 hex nuts 8 mm (.314) across flats, 1 locking ring and 1 lockwasher  
Standard and special hardware available are presented in section I.



**Packaging unit** : 50 to 25 pieces depending on model.

# SF series

## Washable toggle switches - insulated threaded bushing

Solder lug or straight PC terminals

MODEL  
STRUCTURE

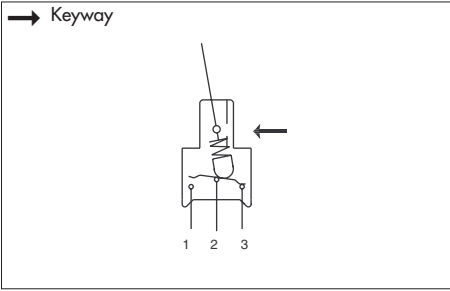

- Single pole configurations
- Max. torque : 0,25 Nm (.184 Ft.lb)
- Iron soldering : 300°C max. 5 sec. max.
- Max. panel thickness :  
2,5 mm (.098) with 2 nuts  
4 mm (.157) with 1 nut

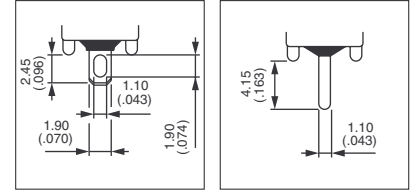

MODEL  
STRUCTURE



Shown with standard lever 00

### Solder lugs : SF..S0

→ Keyway



SF36S0  
SF39S0  
SF37S0  
SF38S0  
SF32S0

III	II	I
2-3		1-2
ON	-	ON
ON	OFF	ON
MOM	OFF	MOM
ON	OFF	MOM
ON	-	MOM

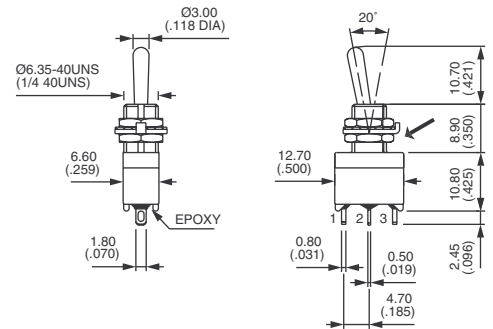

### Straight PC terminals : SF..P0

→ Keyway



SF36P0  
SF39P0  
SF37P0  
SF38P0  
SF32P0

III	II	I
2-3		1-2
ON	-	ON
ON	OFF	ON
MOM	OFF	MOM
ON	OFF	MOM
ON	-	MOM

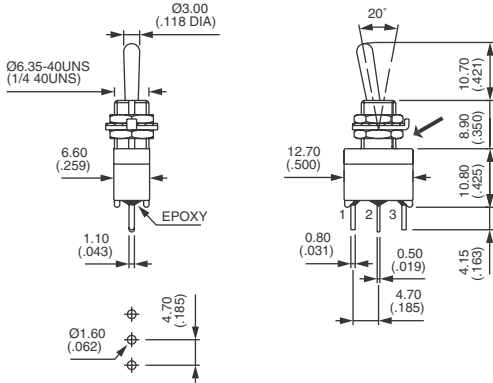

### PANEL CUT-OUT

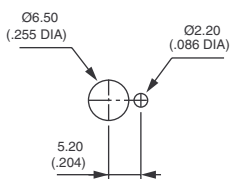





# SF series

## Washable toggle switches - insulated threaded bushing

### CONTACT AND TERMINAL MATERIALS

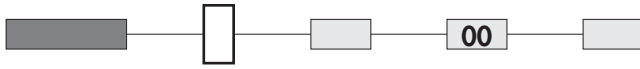

- 0 Brass, gold plated (standard)
- 1 Silver
- 2 Silver, gold plated
- 5 Special contact, lower rating, minimum quantity : consult factory.

### LEVERS

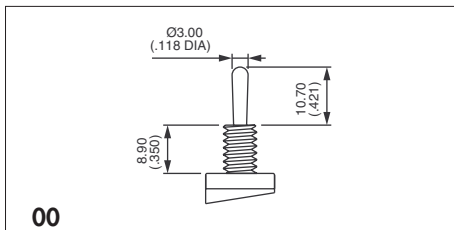
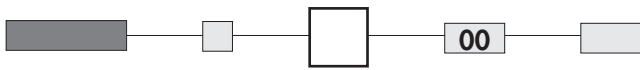

**00**  
Standard

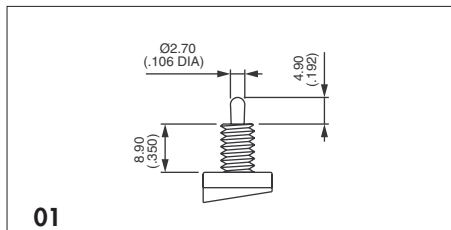

**01**

### Insulated levers

Protected against electrostatic discharges (ESD) up to 12KV. Black colour.

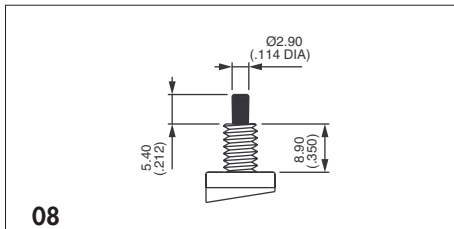

**08**  
Short

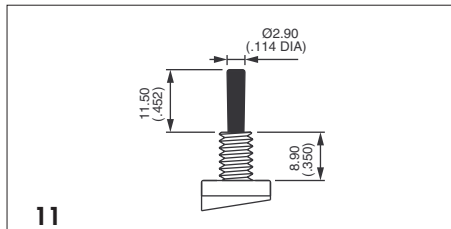

**11**  
Long

### INSULATING CAP

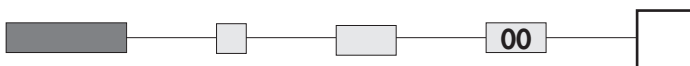

**Blank** Without cap

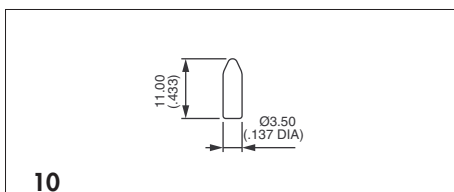

**10**  
P/N U270 - For lever 00

To order cap separately, use its part number (U270).

#### Cap colours

Replace "0" by number

- 1 blue
- 1/4 dark blue
- 2 black
- 3 green
- 4 grey
- 5 yellow
- 6 red
- 7/1 white
- 9 orange

A