



Made in Germany

Go To Pictorial Index  
Go To Numerical Index



*Innovations that work*





Made in Germany

[www.wihatools.com](http://www.wihatools.com)

## Wiha Tool Programs

Description	Page
Torx Tools	14-25
TorqueControl Tools	26-31
Hex Tools	32-43
Maxiflex Hose System	44-46
Sledge/Dead Blow Hammers	47
Nut Drivers	48-53
Wrenches	54-61
Screwdrivers	62-81
SYSTEM 6	76-80
Insulated Tools	81-91
Pliers & Cutters	87-109
Rulers	102
Precision Tools	110-129
SYSTEM 4	122-129
Tweezers/Hooks/Probes/Mirrors	130-146
Bits & Bit Sets	147-165
Bit Holders, Sockets & Sets	166-169

## Wiha Main Product Index

Description	Page
Slotted Tools Index	7
Phillips Tools Index	7
Torx Tools Index	8, 14
Tamper Resistant Torx Index	8, 14
TorxPlus Index	8, 14
Tamper Resistant Hex Index	8, 32
Hex Index	9, 32
Ball End Hex Index	9, 32
MagicRing Index	9, 32
Nut Drivers Index	9, 48
Pozidriv Index	9
Square Index	10
Wrenches Index	10, 48
TorqueControl Index	10, 26
Bit Holders Index	10, 147
Bit Sets Index	10, 147
Miscellaneous Tools Index	11
High Performance Bits Index	11, 147
Standard Bits Index	11, 147
Specialty Bits Index	11, 147
Sockets Index	12, 147
Tweezers Index	12, 130
Insulated Pliers/Cutters Index	12, 81, 87
ComfortGrip Pliers/Cutters Index	13, 87
Vinyl Grip Pliers/Cutters Index	13, 87
ESD Safe Pliers/Cutters Index	13, 87, 103
ESD Safe Tools Index	13, 103

**Numerical Index By Item Number 170-175**



Made in Germany

Toll Free: (800) 494-6104

**NEW**

### Vinyl Grip Pliers & Cutters



Combination	96
Stripping Pliers	96
Long Nose	97
Adjustable	98
Cutters	99
Nippers	100
Retaining Ring	101

### ComfortGrip Pliers & Cutters



Combination	92
Stripping Pliers	92
Long Nose	93
Adjustable	94
Cutters	95

### Insulated Pliers & Cutters



Combination	88
Cutters	89
Long Nose	91

### Wrenches



Open End Inch/Metric	54-55
----------------------	-------



Soft Grip Inch/Metric	56
-----------------------	----



Combination Inch/Metric	57-60
-------------------------	-------



Box Wrenches Inch/Metric	61
--------------------------	----

### Rulers



Inch/Metric Rulers	102
--------------------	-----

### Maxiflex Hose System



Maxiflex 1/4"	45
Maxiflex 1/2"	46

### X-Selectors Bit Sets



Slot/Phil/Torx	148
Torx	148
TR Torx	148
Hex Inch	148

### TorqueControl Tools



TorqueVario-S	26-29
---------------	-------



Insulated TorqueVario-S	30
-------------------------	----



ESD Safe TorqueVario-S	31
------------------------	----

### ESD Safe SoftFinish Drivers



Slotted/Phillips/Torx	68
-----------------------	----

### Orbit Pivot Drivers



Phillips	63
----------	----



### ClicFix Quick Release Holder



ClicFix Quick Release Holder	153
------------------------------	-----



Made in Germany

www.wihatools.com

Correct ordering:

# Prompt Delivery!

The Wiha catalog comprises of 176 pages with over 2850 Items. On these pages you will find important information you need to know to use and order our products correctly and easily.

### Ordering:

Each Item shows an appropriate part number in the list. The bold number in the grey box under **Item no.** is the correct number to use when ordering a product.

The catalog offers three different ways to look up item numbers:

1. On pages 5-6 you will find a numerical index by series. Example: Series 520, MicroFinish Slotted Screwdrivers, can be found on page 69.
2. On pages 7-13 you will find products by the tip style. Example: From page 9, Hex Insert Bits can be found on page 163.
3. On pages 170-175 you will find items in a numerical order index.
4. On page 2 table of contents for programs and index

### Warranty

Wiha warranty states all product shall be free from defects in materials and workmanship upon delivery. Should a product be received that is defective or incomplete, Wiha is only obligated to replace the product, excluding all further warranty. Defective products must be reported and returned immediately upon receipt. Bits, ceramic tools & tweezers are not covered by replacement warranty under any circumstances. Products may be returned to place of purchase or directly to Wiha for replacement.

### Wiha is not liable for the following:

any goods which have been repaired or altered in any way; any goods which have been subject to any accident or damage or which have been maintained, stored or used improperly; any direct consequential loss or damage of anything whatsoever (including without limitation loss of profits revenue or contracts) or for any damage to or destruction of any property; injury to or death of any person except to the extent that such injury or death is caused by negligence on the part of Wiha or its employees; unsuited, inappropriate and faulty application and treatment; normal wear and tear due to use.

### Hand Tool Safety

Always wear proper eye and hand protection when using tools. Always use the proper tool, screwdrivers are not designed for prying, chiseling or scraping. Screwdriver tips should be in good condition and closely fit fastener. Inspect tools periodically and discard worn or damaged items.

® **TORX**® & TORXPlus are registered trademarks of Camcar/Textron.  
® Pozidriv is a registered trademark of Phillips Screw Company.

**520** Slotted screwdriver, with Wiha MicroFinish handle.  
Blade high alloy chrome-vanadium-molybdenum steel, hardened, chrome-plated. Wiha MicroFinish handle, cellulose-acetate, impact resistant, non-slip, oil & grease resistant. Exact fit precision ground tip, Wiha chromtop.

Item No.	Size	Inch	mm	Inch	mm	Inch	mm	Inch	lbs.	pcs.
<b>520 05</b>	4.0	5/32	100	4.0	0.8	.031	211	8.3	.16	10

Item Number	Tip dimension in MM & tip symbol	Tip dimension in Inches	Length of blade in MM	Length of blade in Inches	Tip width in MM	Tip width in Inches	Total length in MM	Total length in Inches	Weight	Packaging units Minimum quantity
520 05	4.0	5/32	100	3.94	0.8	.031	211	8.31	.16	10

Article Information

- Slotted
- Phillips
- Torx
- Tamper Resistant Torx
- Hex/Ball End/MagicRing
- Tamper Resistant Hex
- Nut Driver
- Pozidriv
- Square
- Triwing
- Spanner
- Torq Set
- TorxPlus

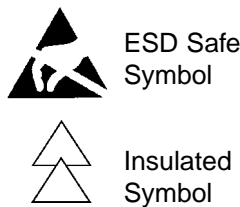

How to compose a bar code  
084705 + ordering number +  
check digit





Made in Germany

**Toll Free: (800) 494-6104**

**Numerical Index by Series**

Series	Description	Page	Series	Description	Page	Series	Description	Page
100	SYSTEM 6 Slotted Blades/Sets	77-78	287	Insulated TorqueControl Blades	30	365	TorxPlus Wing Handle/Set	25
101	SYSTEM 6 Phillips Blades/Sets	77,79	288	ESD Safe TorqueControl Blades/Set	31	365	Wing Torx & Set	22
102	SYSTEM 6 Pozidriv Blades	77	300	Square Reamer	80	366	TorxPlus Long Arm L-keys	25
103	SYSTEM 6 Hex Inch Blades	77	301	Round Scratch Awls	80	367	MagicRing SoftFinish Screwdrivers	39-40
104	SYSTEM 6 Hex Metric Blades	77	302	SoftFinish Mechanics Slotted & Sets	66	369	MagicRing PocketStars	40
105	SYSTEM 6 Inch Nut driver Blades	77	302	ESD Safe SoftFinish Screwdrivers	68	369	Ball End Hex Keys & Sets	34-35
106	SYSTEM 6 Metric Nut driver Blades/Sets	77,79	304	SoftFinish Stubby Slotted	66	370	Flag Torx & Set	22
107	SYSTEM 6 Torx Blades/Sets	19,77,79	308	SoftFinish Heavy Duty Slotted & Sets	65	380	Multi Bit Holders and Sets	85,149,154
108	SYSTEM 6 Handles	76	311	Phillips Orbit Pivot Drivers	63	384	SoftFinish Magnetic Bit Holder	67,154
109	SYSTEM 6 Adapter Blades/Sets	78-79	311	SoftFinish Phillips & Set	66	388	T-Handle Bit Holders	154
109	SYSTEM 6 Extension Blades	78	311	SoftFinish Stubby Phillips	66	394	Screwholding Slotted Drivers	74
111	SYSTEM 6 TR Torx Blades/Sets	19,77,79	312	SoftFinish Heavy Duty Phillips & Set	65	395	Screwholding Phillips Drivers	74
153	Square Handle Phillips	74	313	SoftFinish Pozidriv	67	400	Combination Wrenches Inch/Metric	57-60
161	Offset Phillips Screwdrivers	74	320	Insulated Slotted & Sets	82-83	400	Magnetizer/Demagnetizer	75
186	Square Handle Cabinet Tip Slotted	74	321	Insulated Phillips & Sets	82-83	430	Universal Razor Shaver & Blades	67
207	Offset Slotted Screwdrivers	74	322	Insulated Nut Drivers/Sets	53,84	445	SYSTEM 4 Technicians Blade Kit	124
222	Pozidriv Square handle	74	325	Insulated Torx & Sets	85	455	3K Ergo Torx Screwdrivers & Sets	18
260	Precision Tool Stands & Clips	117	326	Wiha Pliers & Cutters	87-101	455	Protturn Torx Drivers & Sets	17
260	Precision Slotted & Sets	113-114	326	Insulated Retaining Ring Bit Holder	154	460	3K Ergo Slotted Screwdrivers	72
261	Precision Phillips & Sets	113-114	327	ESD Safe Pliers	104-109	460	3k Ergo Slotted & Phillips Sets	73
262	Precision Pozidriv Drivers	115	328	Insulated Pliers/Cutters/Drivers Set	85-86	461	3K Ergo Phillips Screwdrivers	72
263	Precision Hex Drivers & Sets	114	328	Insulated Pliers & Cutters	88-91	467	3k Ergo Ball End Hex Drivers & Sets	41
264	Precision Ballpoint & Sets	115	329	ComfortGrip Combination Pliers	92-95	468	ACO Phillips Screwdrivers	71
265	Precision Nut Drivers & Sets	116	334	Comfort Grip Hex Inch T-handles	37	469	ACO Slotted Screwdrivers	71
267	Precision Torx Drivers & Sets	117	334	Comfort Grip Hex Inch Sets	37	475	Box Wrenches Inch & Metric	61
268	Precision Lifter	117	334	Comfort Grip Hex Metric T-handles	37	481	SYSTEM 6 Mag/Demag Handle	76
269	SYSTEM 4 Handles/Blades	122-123	334	Comfort Grip Hex Metric Set	37	481	SYSTEM 6 Mag/Demag Blade Set	77
269	SYSTEM 4 Sets/Canvas Pouch	124	334	T-Handle Hex & Sets	38	484	Protturn Bit Holder & Torx Bit-Selector	17,154
269	SYSTEM 4 Sets/Fold Out Box	126	336	T-Handle Nut drivers & Sets	52	484	3K Series Bit Holder	73,154
269	SYSTEM 4 Sets/Steel Box	125	339	T-Handle Socket Drivers	52,167	500	SoftGrip Wrenches Inch/Metric	56
270	Precision Ceramic Slotted & Set	112	340	Maxiflex Hose System 1/2"	46	510	Dynamic Slotted Drivers & Set	75
271	Precision Ceramic Phillips & Set	112	341	SoftFinish Nut Drivers & Sets	49	511	Dynamic Phillips Drivers & Set	75
272	Precision ESD Safe Slotted Driver	110	343	SoftFinish Hollow Shaft Nut Drivers	51	520	MicroFinish Slotted Drivers & Set	69
273	Precision ESD Safe Phillips & Set	110-111	344	Maxiflex Hose System 1/4"	45	521	MicroFinish Phillips Drivers & Set	69
275	Precision ESD Safe Hex Metric	112	347	SoftFinish Nut Drivers & Sets	50	526	MicroFinish Bit Holder	69,154
277	Prec ESD Safe Nut Driver Metric	112	350	Open End Wrenches Inch & Metric	54-56	527	MicroFinish Torx Drivers & Set	16
278	Precision ESD Safe Torx Driver/Set	111	351	L-Wrench Hex Keys & Sets	43	530	SoftFinish Heavy Duty Slotted & Set	64
279	Precision Anti-Static Lifter	117	352	Hex L-keys Nickel-Plated Long Arm	42	531	SoftFinish Heavy Duty Phillips & Set	64
280	SYSTEM 4 Anti-Static Handles	122	352	Hex L-Key Sets Nickel-Plated	42	533	MicroFinish Heavy Duty Slotted & Sets	70
280	SYSTEM 4 Ballpoint Blades	123	352	Hex L-keys Black Finish Long Arm	42	534	MicroFinish Heavy Duty Phillips & Set	70
280	SYSTEM 4 Pouch Sets	124	352	Hex L-Key Sets Black Finish	42	540	MagicRing T-handles & Sets	36
280	SYSTEM 4 Anti-Static Sets	125	353	Hex Black L-keys - Short Arm	43	616	Maxiflex Folding Rulers	102
281	SYSTEM 6 SoftFinish Handle	76	353	Hex Black L-key Sets	43	668	Precision Bit Holder	119,154
281	SYSTEM 6 T-Handle	76	358	SoftFinish Square Driver	67	629	SYSTEM 4 Protturn Blade Sets	120
282	SYSTEM 6 Topra Handle	76	361	TorxPlus L-keys	25	669	MagicRing Ball End Metric Hex L-key	33
282	SYSTEM 6 Topra Blade Sets	80	362	ESD Safe SoftFinish Torx Drivers	16,68	669	MagicRing Ball End Inch Hex L-key	33
282	SYSTEM 6 Topra Ratchet Bit Sets	19	362	Powerhandle Torx Drivers & Sets	16	669	MagicRing Ball End L-Key Sets	33
284	SYSTEM 6 Long Blades	78	362	TorxPlus SoftFinish Screwdriver	24	701	Tamper Resistant Torx 1/4" Bits	161
285	TorqueControl Handles	27	362	SoftFinish Torx/TR Torx & Sets	15	701	Tamper Resistant Torx Carded Bits	162
285	Torque Blades Slotted/Phillips/Hex/Torx	29	363	Tamper Resistant Torx L-keys & Sets	23	701	Tamper Resistant Sockets & Sets	167-169
285	TorqueControl Adapters	28	363	L-Wrench Torx Keys & Sets	22-23	704	Nut Setters Inch and Metric	166
285	TorqueControl Sets	28	363	PocketStars Torx/TR Torx	21	705	Tamper Resistant Torx Power Bits	161
285	Insulated TorqueControl Handle	30	364	Comfort Grip Torx T-handles & Set	20	710	Slotted/Phillips/Hex Bit-Selector	151
285	ESD Safe TorqueControl Handle	31	364	T-Handle TorxPlus & Set	24	710	Dura Insert Bit-Selector	152
			364	T-Handle Torx & Sets	20-21	710	Dura Insert Bits Slotted	155





Made in Germany

Toll Free: (800) 494-6104

## Slotted Index

	<u>DESCRIPTION</u>	<u>Page</u>
	SoftFinish® Cushion Grip	64-66
	ESD Safe SoftFinish Cushion Grip	68
	MicroFinish Non-Slip Grip	69-70
	3K Series	72-73
	Anti Cam-Out	71
	Insulated Cushion Grip	82-83
	Square Handle Cabinet Tip	74
	Stubby SoftFinish	66
	Screwholding	74
	Dynamic	75
	SYSTEM 6 Blades	77-78
	Offsets	74
	Insert Bits Dura, Diamond & Standard	155,157
	Power Bits	157
	ESD Safe Precision	111
	Ceramic Precision	112
	Precision	113-114,121
	Protturn Precision	118
	SYSTEM 4 Blades	122
	SYSTEM 4 Micro Bits	127

## Phillips Index

	<u>DESCRIPTION</u>	<u>Page</u>
	Orbit Pivot Driver	63
	SoftFinish® Cushion Grip	64-66
	ESD Safe SoftFinish Cushion Grip	68
	MicroFinish Non-Slip Grip	69-70
	3K Series	72-73
	Anti Cam-Out	71
	Insulated Cushion Grip	82-83
	Square Handle	74
	Stubby SoftFinish	66
	Screwholding	74
	Dynamic	75
	SYSTEM 6 Blades	77-78
	Offsets	74
	Insert Bits Dura, Diamond, TiN & Standard	155-156 158-159
	Power Bits & TiN Coated	156 158-159
	ESD Safe Precision	111
	Ceramic Precision	112
	Precision	113-114,121
	Protturn Precision	118
	SYSTEM 4 Blades	122
	SYSTEM 4 Micro Bits	127



Made in Germany

www.wihatools.com

## Torx® Index

	<u>DESCRIPTION</u>	<u>Page</u>
	SoftFinish® Cushion Grip	15
	MicroFinish Non-Slip Grip	16
	3K Series	18
	Protturn	17
	Insulated Cushion Grip	85
	SYSTEM 6 Blades	19
	Powerhandle	16
	Wing Handle	22
	Flag Handle	22
	L-Keys	22-23
	T-handle & ComfortGrip	20-21
	PocketStar Fold Outs	21
	ESD Safe SoftFinish Cushion Grip	68
	Bit Sets	150,156
	Insert & Power Bits	160-162
	Sockets & Sets	167-169
	ESD Safe Precision	111
	Precision	117,121
	Protturn Precision	120
	SYSTEM 4 Blades	123
	SYSTEM 4 Micro Bit	128

## Tamper Resistant Torx® Index

	<u>DESCRIPTION</u>	<u>Page</u>
	SoftFinish® Cushion Grip	15
	SYSTEM 6 Blades	19,77
	L-Keys	23
	PocketStar Fold Outs	21
	Insert Bits	161-162
	Power Bits	161-162
	SYSTEM 4 Micro Bits	128

## TorxPlus® Index

	<u>DESCRIPTION</u>	<u>Page</u>
	Torque Blade	29
	SoftFinish® Cushion Grip	24
	Insert Bits	161
	Bit-Selector	151
	Power Bits	161
	T-handles	24
	L-Keys Short/Long Arm	25
	Wing Handle	25

## Tamper Resistant Hex Index

	<u>DESCRIPTION</u>	<u>Page</u>
	Insert Bits	163
	SYSTEM 4 Micro Bits	127

























Made in Germany

Toll Free: (800) 494-6104







## Hex Index

	<u>DESCRIPTION</u>	<u>Page</u>
	SYSTEM 6 Blades	77
	T-handle & ComfortGrip	37-38
	L-wrenches	42-43
	Power Bits	163
	Insert Bits	163
	ESD Safe Precision	112
	Precision	114,121
	Protorn	119
	SYSTEM 4 Blades	123
	SYSTEM 4 Micro Bits	127
	Sockets	167-169
	Insert & Power Bit Sets	150-151









## Nut Drivers Index

	<u>DESCRIPTION</u>	<u>Page</u>
	SoftFinish® Cushion Grip	49-51
	Insulated Cushion Grip	53,84
	SYSTEM 6 Blades	77-78
	SYSTEM 4 Blades	123
	T-handle	52
	Nut Setters	166
	ESD Safe Precision	112
	Precision	116,121



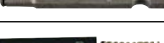



## Ball End Hex Index

	<u>DESCRIPTION</u>	<u>Page</u>
	3K Series Screwdrivers	41
	ComfortGrip T-handles	37
	Precision	115,121
	Protorn	119
	SYSTEM 6 Blades	78
	SYSTEM 4 Blades	123
	Ball End L-keys & Sets	34

## MagicRing Index

	<u>DESCRIPTION</u>	<u>Page</u>
	L-Keys	33
	T-handles	36
	Insert Bits	162
	Power Bits	162
	Bit-Selectors Insert & Power Bits	152
	SoftFinish	39-40
	PocketStars	40

## Pozidriv® Index



	<u>DESCRIPTION</u>	<u>Page</u>
	SoftFinish® Cushion Grip	67
	Square Handle Long	74
	SYSTEM 6 Blades	78
	SYSTEM 4 Blades	122
	Insert Bits	164
	Power Bits	164
	Precision	115







Made in Germany

www.wihatools.com











## Square Index

	<u>DESCRIPTION</u>	<u>Page</u>
	SoftFinish® Cushion Grip	67
	Insert Bits	164-165
	Power Bits	164











## Wrenches Index

	<u>DESCRIPTION</u>	<u>Page</u>
	Open End Inch/Metric	54-56
	Soft Grip Wrenches Inch/Metric	56
	Combination Inch/Metric	57-60
	Box Wrenches Inch/Metric	61







## TorqueControl Index

	<u>DESCRIPTION</u>	<u>Page</u>
	TorqueFix Handle	27
	TorqueVario Handle	27
	Slotted Blade	29
	Phillips Blade	29
	Torx Blade	29
	TorxPlus Blade	29
	Insulated TorqueControl	30
	Insulated Blades	30
	ESD Safe TorqueControl	31
	ESD Safe Blades	31
	TorqueControl Sets	28,31

## Bit Holders Index

	<u>DESCRIPTION</u>	<u>Page</u>
	SoftFinish® Cushion Grip	67,154
	MicroFinish Non-Slip Grip	69,154
	Protturn	17,154
	Insulated Bit Holder SoftFinish® Cushion Grip	85,154
	3K Ergo Bit Holder	73,154
	Protturn Precision	119,154
	T-handle	52,154
	Powerhandle Bit Holder	154
	ClicFix Quick Release	166
	Magnetic Bit Holders	166
	Retainig Ring Bit Holder	166

## Bit Sets Index











	<u>DESCRIPTION</u>	<u>Page</u>
	Topra Bit Sets	19,147
	Six in One Bit Sets	149
	Bit Selector Sets	150-152
	Power Bit-Selector	151-152
	Bits Collector Set	153
	MicroBit Sets	128-129
	XSelectors	148



Made in Germany

Toll Free: (800) 494-6104

## Miscellaneous Index

	<u>DESCRIPTION</u>	<u>Page</u>
	SoftFinish Scraper Cushion Grip	67
	Magnetizer/Demagnetizer	75
	Round Awls	80
	Square Reaming Awls	80
	Dead Blow/Sledge Hammers	47
	Hickory Handle Dead Blow	47
	T-handle Socket Adapter	167,52
	Precision Tool Clips	117
	Lifters	117,119
	Tool Stands/Racks	67,117







## High Performance Bits Index

	<u>DESCRIPTION</u>	<u>Page</u>
	Slotted Dura Insert Bits	155
	Phillips Dura Insert Bits Insert/Power Bits	155
	Pozidriv® Dura Insert Bits Insert/Power Bits	155
	Torx® Dura Insert Bits	155
	Slotted Diamond Bits	155
	Phillips Diamond Bits Insert/Power Bits	155







## High Performance Bits Index

	<u>DESCRIPTION</u>	<u>Page</u>
	Pozidriv Diamond Bits	155
	Torx® Diamond Bits	155
	Phillips TiN Coated Insert/Power Bits	156
	Torx® TiN Coated	156

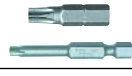
## Standard Bits Index

	<u>DESCRIPTION</u>	<u>Page</u>
	Slotted Insert/Power Bits	157
	Phillips Insert/Power Bits	158-159
	Torx® Insert/Power Bits	160-162
	Hex Metric & Inch Insert/Power Bits	163
	Pozidriv® Insert/Power Bits	164
	Square Insert/Power Bits	164-165

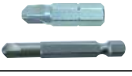
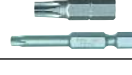
## Specialty Bits Index

















	Torx® Align Bits Insert/Power Bits	161
	Tamper Resistant Torx Insert/Power Bits	161-162
	Tamper Resistant Hex	163
	Spanner	165
	Triwing Insert/Power Bits	165
	Torq Set Insert/Power Bits	165
	TorxPlus® Insert/Power Bits	161
	Micro Bits	127-128











Made in Germany

www.wihatools.com







## Tweezers Index

	<u>DESCRIPTION</u>	<u>Page</u>
	ESD Safe Tweezers	131-133
	Microfine Tweezers	133
	Standard Tweezers	134-136
	Wafer Tweezers	137-138
	Cutting Tweezers	138
	Guide Pin Tweezers	139-140
	Long Tweezers	140
	Surface Mount Tweezers	141-142
	Isolated Tweezers	142
	Super Thin Tweezers	142
	Self Closing Tweezers	142-143
	Interchangeable Tweezers	144
	Inspection Mirrors	144
	All Stainless Excavators	145
	All Stainless Probes	145-146
	All Stainless Hooks	146

## Sockets Index

	<u>DESCRIPTION</u>	<u>Page</u>
	Torx 1/4" Drive	167
	Torx 3/8" Drive	167
	Torx 3/8" - 5/16" Bits	167
	Tamper Resistant Torx 3/8"	167
	External Torx Sockets 1/4", 3/8", 1/2"	167
	Hex Bit Sockets 1/4" Drive	167-168
	Hex Bit Sockets 3/8" Drive	167-168
	6" Bit Sockets 1/4" Drive	168
	Socket Sets	169

## ESD Safe Tools

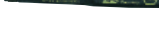





	<u>DESCRIPTION</u>	<u>Page</u>
	TorqueControl Drivers	31
	SoftFinish Drivers	68
	SYSTEM 6 Handles	76
	Pliers & Cutters	104-109
	Precision Screwdrivers	110-112
	SYSTEM 4	122,124-129
	Tweezers	131-133



Made in Germany

Toll Free: (800) 494-6104











### ComfortGrip Pliers/Cutters Index

	<u>DESCRIPTION</u>	<u>Page</u>
	Combination Pliers	92
	Stripping Pliers	92
	Long Nose	93
	Bent Long Nose	93
	Flat Nose	93
	Adjustable Pliers	94
	Diagonal Cutters	95









### ESD Safe Pliers/Cutters Index

	<u>DESCRIPTION</u>	<u>Page</u>
	Diagonal Cutters Small Tapered Head	104
	Diagonal Cutters Wide Tapered Head	105
	Diagonal Cutters Slim Oval Form	105-106
	Diagonal Cutters Wide Oval Form	106
	Oblique Angled Cutters Angled Cutters	107
	End Cutters	108
	Pliers Needle Nose, Round, Flat	108-109

### Standard Pliers/Cutters Index

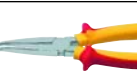
	<u>DESCRIPTION</u>	<u>Page</u>
	Combination Pliers	96
	Stripping Pliers	96
	Long Nose	97
	Bent Long Nose	97
	Flat Nose	97
	Long Round Nose	97
	Adjustable Pliers	98
	Retaining Ring Pliers	101
	High Leverage Cutters	99
	Mason Nippers	100

### Insulated Pliers & Cutters

	<u>DESCRIPTION</u>	<u>Page</u>
	Combination	88
	Heavy Duty Side Cutters	89
	High Leverage Side Cutters	89
	Cable Cutter	89
	Bent Nose	90
	Long Nose	91
	Round Nose	91
	Stripping Pliers	91



Made in Germany

www.wihatools.com

**Wiha Torx® & Tamper Resistant Torx Index**

	Description	Page
	SoftFinish Screwdrivers Torx & Tamper Resistant Torx	15
	ESD Safe SoftFinish Drivers	16
	Powerhandle	16
	MicroFinish Non-Slip Grip	16
	Protturn Screwdrivers	17
	3K Series Screwdrivers	18
	SYSTEM 6 Blades & Sets	19
	SYSTEM 6 Topra Ratchet	19
	ComfortGrip T-handle L-key	20
	T-handles	21
	PocketStar Fold Outs	21
	Wing Handle Screwdrivers	22
	Flag Handle Screwdrivers	22
	L-keys - Short Arm	22
	L-keys - Long Arm	23
	Security L-keys Short	23
	TorqueControl Torx Blade	29
	Insulated Torx Screwdrivers	85
	XSelector Bit Sets	148
	Bit-Selectors	150-153
	Insert & Power Bits	160-162
	Torx Align Insert/Power Bits	161
	Tamper Resistant Bits	161-162
	TorxPlus Insert/Power Bits	161
	Carded Bits	162
	Dura Insert/Power Bits	155
	Diamond Insert/Power Bits	155
	TiN Coated Insert/Power Bits	156
	Sockets & Sets	167-168

	Description	Page
	E Torx Sockets & Sets	167
	Socket Sets On Rail	167,169
	ESD Safe Screwdrivers	111
	Precision Screwdrivers	117,121
	Protturn Precision Drivers	120
	SYS 4 Precision Handles/Blades/Sets	122-126
	SYSTEM 4 MicroBits Handles/Blades/Sets	127-129
	Torx Multi Bit Sets	149

**Wiha TorxPlus® Index**

	Description	Page
	SoftFinish Screwdrivers	24
	T-handles	24
	L-Keys	25
	Wing Handle Screwdrivers	25
	Insert & Power Bits	161
	Bit-Selectors	151



**TORX® REFERENCE CHART**

Across Point Dimensions      Approximate Torque

Size	mm	Inch	Nm	In/Lbs.
T1	.81	.031	0.03	.266
T2	.93	.036	0.07	.797
T3	1.10	.043	0.18	1.59
T4	1.26	.049	0.27	2.39
T5	1.42	.056	0.43	3.81
T6	1.70	.067	0.75	6.64
T7	1.99	.078	1.4	12.39
T8	2.31	.091	2.2	19.47
T9	2.50	.098	2.8	24.78
T10	2.74	.108	3.7	32.75
T15	3.27	.129	6.4	56.64
T20	3.86	.152	10.5	92.93
T25	4.43	.174	15.9	140.73
T27	4.99	.197	22.5	199.14
T30	5.53	.218	31.1	275.86
T40	6.65	.262	54.1	478.83
T45	7.82	.308	86.2	762.93
T50	8.83	.348	132	1168.30
T55	11.22	.442	252	2230.39
T60	13.25	.522	437	3867.78



Made in Germany

Toll Free: (800) 494-6104

Wiha TORX® SoftFinish® Screwdrivers - Ergonomic Cushion Grip Handle



**362 TORX® Screwdriver, With Wiha-SoftFinish® Handle.**

Round blade high alloy chrome-vanadium-molybdenum steel, hardened, chrome-plated, Wiha-Chromtop finish on tips. Wiha-SoftFinish® handle, multi-component, cushion grips.

Item No.	Size	mm	Inch	mm	Inch	mm	Inch	lbs.	pkg.	Each
362 64	T5	60	2.4	2.5	.098	164	6.5	.05	10	\$5.00
362 66	T6	60	2.4	3.5	.139	164	6.5	.06	10	\$3.80
362 68	T7	60	2.4	3.5	.139	164	6.5	.06	10	\$3.60
362 70	T8	60	2.4	3.5	.139	164	6.5	.06	10	\$3.70
362 72	T9	60	2.4	4.0	.157	171	6.7	.10	10	\$4.20
362 74	T10	80	3.0	4.0	.157	191	7.5	.11	10	\$4.30
362 76	T15	80	3.0	4.0	.157	191	7.5	.11	10	\$4.50
362 78	T20	100	4.0	4.0	.157	211	8.3	.11	10	\$4.70
362 80	T25	100	4.0	4.5	.177	211	8.3	.12	10	\$5.40
362 82	T27	115	4.5	5.5	.216	233	9.2	.19	10	\$6.20
362 84	T30	115	4.5	6.0	.236	233	9.2	.20	10	\$7.40
362 86	T40	130	5.1	7.0	.275	254	10.0	.27	10	\$7.90
362 88	T45	130	5.1	8.0	.315	254	10.0	.31	10	\$8.40



**362 TR Tamper Resistant TORX® Screwdriver With Wiha-SoftFinish® Handle.** Round blade high alloy chrome-vanadium-molybdenum steel, hardened, chrome-plated, Wiha-Chromtop finish on tips. Wiha-SoftFinish® handle, multi-component, cushion grips.

Item No.	Size	mm	Inch	mm	Inch	mm	Inch	lbs.	pkg.	Each
362 69	TR7	60	2.4	3.5	.139	164	6.5	.06	10	\$6.42
362 71	TR8	60	2.4	3.5	.139	164	6.5	.06	10	\$6.42
362 73	TR9	60	2.4	4.0	.157	171	6.7	.10	10	\$6.62
362 75	TR10	80	3.0	4.0	.157	191	7.5	.11	10	\$6.62
362 77	TR15	80	3.0	4.0	.157	191	7.5	.11	10	\$6.82
362 79	TR20	100	4.0	4.0	.157	211	8.3	.11	10	\$8.52
362 81	TR25	100	4.0	4.5	.177	211	8.3	.11	10	\$8.62
362 83	TR27	115	4.5	5.5	.216	233	9.2	.19	10	\$10.20
362 85	TR30	115	4.5	6.0	.236	233	9.2	.20	10	\$12.00
362 87	TR40	130	5.1	7.0	.275	254	10.0	.28	10	\$13.00

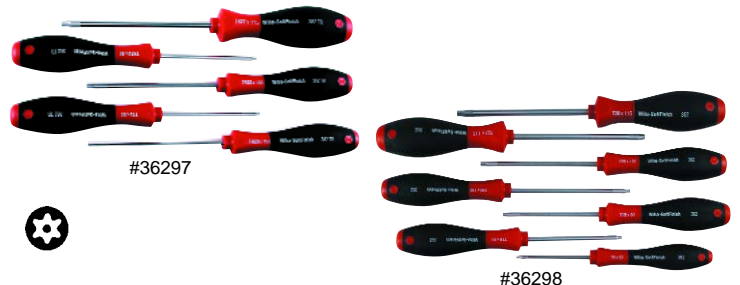

**362 97 Set 5 Pcs. Tamper Resistant TORX®**

Item No.	Size	mm	Size	mm	lbs.		
362 97	362 75	TR10	80	362 81	TR25	100	.91
	362 77	TR15	80	362 83	TR27	115	Each
	362 79	TR20	100				\$40.90

**362 98 Set 7 Pcs. Tamper Resistant TORX®**

Item No.	Size	mm	Size	mm	lbs.		
362 98	362 69	TR7	60	362 77	TR15	80	.95
	362 71	TR8	60	362 79	TR20	100	
	362 73	TR9	60	362 81	TR25	100	Each
	362 75	TR10	80				\$49.98

**362 91 Set 6 Pcs. TORX®**

Round blade high alloy chrome-vanadium-molybdenum steel, hardened, chrome-plated. Wiha-Chromtop finish on tips. Wiha-SoftFinish® handle, multi-component, cushion grips.

Item No.	Size	mm	Size	mm	lbs.		
362 91	362 66	T6	60	362 72	T9	60	.77
	362 68	T7	60	362 74	T10	80	Each
	362 70	T8	60	362 76	T15	80	\$23.98

**362 94 Set 8 Pcs. TORX®**

Item No.	Size	mm	Size	mm	lbs.		
362 94	362 66	T6	60	362 78	T20	100	1.24
	362 70	T8	60	362 80	T25	100	
	362 74	T10	80	362 82	T27	115	Each
	362 76	T15	80	362 84	T30	115	\$39.98

See SoftFinish® Cushion Grip Screwdrivers On Pages 63-68



Made in Germany

www.wihatools.com

**Wiha SoftFinish ESD Safe Handle**

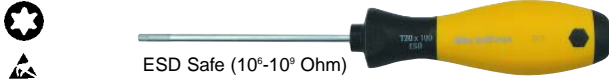

ESD Safe (10<sup>6</sup>-10<sup>9</sup> Ohm)

**362 ESD Safe TORX® Screwdriver, With Wiha-SoftFinish® Handle**

DIN EN 61340-5-1/ 61340-5-2 Round blade, CVM steel, hardened, chrome-plated. Offers protection against electrostatic discharge. Dissipative SoftFinish® cushion grip handle, multi-component.

Item	Size	mm	Inch	mm	Inch	mm	Inch	lbs.	pkg.	Each
362 04	T4	60	2.4	3.5	.139	164	6.5	.06	10	\$5.98
362 06	T6	60	2.4	3.5	.139	164	6.5	.06	10	\$5.98
362 08	T8	60	2.4	3.5	.139	164	6.5	.06	10	\$5.98
362 09	T9	60	2.4	4.0	.157	171	6.7	.10	10	\$5.98
362 18	T10	80	3.0	4.0	.157	191	7.5	.11	10	\$5.98
362 19	T15	80	3.0	4.0	.157	191	7.5	.11	10	\$5.98
362 24	T20	100	4.0	4.0	.157	211	8.3	.11	10	\$5.98



**362 89 Set 6 Pcs. ESD Safe TORX® Screwdrivers**

Includes: T6, T8, T9, T10, T15, T20 lbs. .81 Each \$33.98

**Wiha Powerhandle TORX®**

Made in Germany



**362 TORX® Screwdriver, With Wiha-Powerhandle**

CVM steel blade, hardened, chrome-plated. Wiha-powerhandle cellulose-acetate.

Item	Size	mm	Inch	mm	Inch	mm	Inch	lbs.	pkg.	Each
362 05	T5	50	2.0	2.5	.098	110	4.3	.03	10	\$5.30
362 10	T6	50	2.0	3.5	.139	125	4.9	.06	10	\$4.00
362 12	T7	50	2.0	3.5	.139	125	4.9	.06	10	\$3.80
362 15	T8	60	2.4	3.5	.139	135	5.3	.06	10	\$3.90
362 20	T9	60	2.4	4.0	.157	140	5.5	.09	10	\$4.40
362 25	T10	80	3.0	4.0	.157	170	6.7	.13	10	\$4.50
362 30	T15	80	3.0	4.0	.157	170	6.7	.13	10	\$4.70
362 35	T20	100	4.0	4.0	.157	200	7.9	.17	10	\$4.90
362 40	T25	100	4.0	4.5	.177	200	7.9	.18	10	\$5.60
362 45	T27	115	4.5	5.5	.216	215	8.5	.20	10	\$6.40
362 50	T30	115	4.5	6.0	.236	225	8.9	.28	10	\$7.60



**362 92 8 Pc. Set TORX®**

Blade high alloy CVM steel, hardened, chrome-plated. Wiha-powerhandle cellulose-acetate, impact resistant.

Item No.	Includes:	lbs.	Each
362 92	T6, T8, T10, T15, T20, T25, T27, T30	1.45	\$40.20
362 93	T6, T7, T8, T9, T10, T15	.78	\$25.60

**Wiha TORX® MicroFinish Handle Non-Slip Grip**

Wiha MicroFinish handle has a patented non-slip surface - it won't peel, crack or deteriorate when exposed to petroleum solvents. Oil and moisture flow away from the handle surface for a powerful, non-slip grip. You get maximum force and comfort with dry, oily or wet hands.

Safe, high density material, eliminates risk of sharp objects becoming embedded in the handle

Blades are hardened & chrome-plated

Exact fit precision ground tips

MicroFinish Handle with patented non-slip surface. Ergo handle shape for maximum comfort & exceptional torque transfer

Blade CVM, hardened & tempered tool steel, gives exceptional tool life, wear resistance & high torque performance



**527 TORX® Screwdriver, With Wiha-MicroFinish Handle**

Blade high alloy chrome-vanadium-molybdenum steel, hardened, chrome-plated. Wiha-MicroFinish handle, cellulose-acetate, impact resistant, non-slip, oil and grease resistant. Round blades.

Item	Size	mm	Inch	mm	Inch	mm	Inch	lbs.	pkg.	Each
527 11	T9	60	2.3	4.0	.157	171	6.7	.15	10	\$5.50
527 13	T10	80	3.1	4.0	.157	191	7.5	.15	10	\$5.60
527 16	T15	80	3.1	4.0	.157	191	7.5	.15	10	\$5.90
527 19	T20	100	4.0	4.0	.157	211	8.3	.15	10	\$6.20
527 22	T25	100	4.0	4.5	.177	211	8.3	.16	10	\$7.10
527 26	T27	115	4.5	5.5	.216	233	9.2	.25	10	\$8.20
527 29	T30	115	4.5	6.0	.236	233	9.2	.27	10	\$9.80
527 32	T40	130	5.1	7.0	.275	254	10.0	.40	10	\$10.70



**527 90 Set 5 Pcs. TORX®**

Blade chrome-vanadium-molybdenum steel, hardened, round blades chrome-plated. Wiha-MicroFinish handle, cellulose-acetate, impact resistant, non-slip, oil and grease resistant.

Item	Size	mm	Size	mm	lbs.		
527 90	527 13	T10	80	527 22	T25	100	1.0
	527 16	T15	80	527 29	T30	115	Each
	527 19	T20	100				\$34.80

See MicroFinish Non-Slip Grip Screwdrivers On Page 69-70





Made in Germany

Toll Free: (800) 494-6104

Wiha TORX® Protturn Screwdrivers



**455 91 Set 6 Pcs. TORX®**

Item	✳	—	✳	—	↔
No.	Size	mm	Size	mm	lbs.
455 91	455 06	T7 50	455 21	T10 80	.72
	455 11	T8 60	455 26	T15 80	Each
	455 16	T9 60	455 31	T20 100	\$16.98

**455 92 Set 8 Pcs. TORX®**

Item	✳	—	✳	—	↔
No.	Size	mm	Size	mm	lbs.
455 92	455 11	T8 60	455 31	T20 100	1.07
	455 16	T9 60	455 36	T25 100	
	455 21	T10 80	455 41	T27 115	Each
	455 26	T15 80	455 46	T30 115	\$25.98



**455 TORX® Screwdriver, With Wiha-Protturn Handle**  
Blade high alloy CVM steel, hardened, black finish. Molded on ergonomic Wiha-Protturn handle, molded on, impact resistant.

Item	✳	—	↔	↔	↔	↔	↔	↔	↔	↔
No.	Size	mm	Inch	mm	Inch	mm	Inch	lbs.	pkg.	Each
455 05	T6	50	2.0	3.5	.139	129	5.1	.05	10	\$2.40
455 06	T7	50	2.0	3.5	.139	129	5.1	.05	10	\$2.20
455 11	T8	60	2.4	3.5	.139	139	5.5	.06	10	\$2.30
455 16	T9	60	2.3	4.0	.157	149	5.8	.08	10	\$2.60
455 21	T10	80	3.1	4.0	.157	170	6.7	.10	10	\$2.60
455 22	T10	275	10.8	4.0	.157	363	14.2	.13	10	\$4.30
455 26	T15	80	3.1	4.0	.157	170	6.7	.10	10	\$2.70
455 28	T15	275	10.8	4.0	.157	373	14.6	.15	10	\$4.70
455 31	T20	100	4.0	4.0	.157	190	7.5	.11	10	\$3.90
455 36	T25	100	4.0	4.5	.177	190	7.5	.11	10	\$3.30
455 41	T27	115	4.5	5.5	.216	215	8.4	.11	10	\$3.80
455 46	T30	115	4.5	6.0	.236	215	8.4	.20	10	\$4.50
455 51	T40	130	5.1	7.0	.275	240	9.4	.28	10	\$5.10
455 56	T45	130	5.1	8.0	.315	240	9.4	.27	10	\$5.40
455 61	T50	130	5.1	9.0	.354	240	9.4	.31	10	\$5.50



**484 00 1/4" Bit Holding Screwdriver, With Wiha-Protturn Handle**  
Magnetic, holds bit and screw. Retainer out of stainless steel. Shaft CVM steel, nickel-plated. Handle, molded on, impact resistant.

Item	○	—	—	—	↔	↔	
No.	Size	mm	Inch	mm	Inch	lbs. pcs.	each
484 00	1/4	125	5.0	243	9.6	.24 10	\$6.28



**484 95 Wiha-Protturn Handle Bit Holder & TORX® Bit-Selector Set**  
Magnetic, holds bit and screw. Retainer out of stainless steel. Shaft chrome-vanadium steel, nickel-plated.  
Set includes 1/4" magnetic bit holder and 10 bits.

✳ TORX® sizes:	↔	Each
T6, T7, T8, T9, T10, T15, T20, T25, T27, T30	.53	\$21.98



Made in Germany

www.wihatools.com

Wiha TORX® 3K Series Screwdrivers and Sets



**455 TORX® Screwdriver, With Wiha-3K Series Handle**  
Blade high alloy CVM steel, hardened, black finish. Molded on ergonomic Wiha-3K Series handle, molded on, impact resistant.

Item No.	Size	mm	Inch	mm	Inch	mm	Inch	lbs.	pkg.	Each
455 04	T6	60	2.0	3.2	9/64	145	5.7	.06	10	\$3.30
455 07	T7	60	2.0	3.5	9/64	129	5.1	.05	10	\$3.30
455 08	T8	60	2.4	3.5	9/64	139	5.5	.06	10	\$3.40
455 09	T9	60	2.3	4.0	5/32	149	5.8	.08	10	\$3.60
455 10	T10	80	3.1	4.0	5/32	170	6.7	.10	10	\$3.60
455 12	T10	275	10.8	4.0	5/32	372	14.6	.14	10	\$5.40
455 15	T15	80	4.0	4.0	5/32	190	7.5	.11	10	\$3.80
455 18	T15	275	10.8	4.0	5/32	381	14.9	.16	10	\$5.50
455 20	T20	100	4.5	5.5	7/32	215	8.4	.11	10	\$4.00
455 25	T25	100	4.5	6.0	1/4	215	8.4	.20	10	\$4.30
455 27	T27	115	5.1	7.0	9/32	240	9.4	.28	10	\$4.80
455 30	T30	115	4.5	6.0	1/4	233	9.1	.21	10	\$5.40
455 40	T40	130	5.1	7.0	9/32	248	9.7	.25	10	\$6.00
455 45	T45	130	5.1	8.0	5/16	249	9.8	.30	10	\$6.10
455 50	T50	130	5.1	9.0	3/8	249	9.8	.33	10	\$6.30



**455 93 Set 5 Pcs. Torx®**  
Blade chrome-vanadium-molybdenum steel, hardened, black finish. Wiha-3k Ergo handle, cushion grip.

Item No.	Size	mm	Size	mm	lbs.		
455 93	455 08	T8	60	455 20	T20	100	.86
	455 10	T10	80	455 25	T25	100	Each
	455 15	T15	80				\$17.98



**455 98 Set 6 Pcs. Torx®**  
Blade chrome-vanadium-molybdenum steel, hardened, black finish. Wiha-3k Ergo handle, cushion grip.

Item No.	Size	mm	Size	mm	lbs.		
455 98	455 04	T6	60	455 09	T9	60	.88
	455 07	T7	60	455 10	T10	80	Each
	455 08	T8	60	455 15	T15	80	\$20.98



**455 95 Set 8 Pcs. Torx®**  
Blade chrome-vanadium-molybdenum steel, hardened, black finish. Wiha-3k Ergo handle, cushion grip.

Item No.	Size	mm	Size	mm	lbs.		
455 95	455 08	T8	60	455 20	T20	100	1.36
	455 09	T9	60	455 25	T25	100	
	455 10	T10	80	455 27	T27	115	Each
	455 15	T15	80	455 30	T30	115	\$31.98



**455 96 Set 4 Pcs. Torx®**  
Blade chrome-vanadium-molybdenum steel, hardened, black finish. Wiha-3k Ergo handle, cushion grip.

Item No.	Size	mm	Size	mm	lbs.		
455 96	455 10	T10	80	455 20	T20	100	Each
	455 15	T15	80	455 25	T25	100	\$14.98



**455 97 Set 11 Pcs. Torx® 3K Ergo Series Screwdriver Set**  
Blade chrome-vanadium-molybdenum steel, hardened, black finish. Wiha-3k Ergo handle, cushion grip.

Item No.	Size	mm	Size	mm	lbs.		
455 97	455 04	T6	60	455 20	T20	100	1.72
	455 07	T7	60	455 25	T25	100	
	455 08	T8	60	455 27	T27	115	
	455 09	T9	60	455 30	T30	115	
	455 10	T10	80	455 40	T40	130	Each
	455 15	T15	80				\$43.98



Made in Germany

Toll Free: (800) 494-6104

# SYSTEM 6

## Handles • Blades • Sets

Rotating cap turns freely while applying pressure to tight fasteners.

Collet lock eliminates loose fitting blades.



Narrow diameter allows 40% more turning clearance. Gives high visibility to fastener.

Long, slender grips for extended reach

See SYS 6 Handles on page 76

These blades can also be used in Topra Ratchet handle



**107 SYSTEM 6 TORX® Interchangeable Blade**, high alloy CVM tool steel, hardened, corrosion protected. **TORX®** on 6mm SYS 6 Hex.

Item	Size	lbs.	pkg.	Each
107 00	T8	.10	1	\$4.50
107 03	T9	.10	1	\$4.50
107 06	T10	.10	1	\$4.50
107 09	T15	.10	1	\$4.50
107 12	T20	.10	1	\$4.50
107 15	T25	.10	1	\$4.50
107 18	T27	.10	1	\$4.50
107 21	T30	.10	1	\$4.50
107 24	T40	.11	1	\$4.50

These blades can also be used in Topra Ratchet handle



**111 SYSTEM 6 Tamper Resistant TORX® Interchangeable Blade**, high alloy CVM tool steel, hardened, corrosion protected. **TORX®** on 6mm SYS 6 Hex. Blade length 140mm/5.5".

Item	Size	lbs.	pkg.	Each
111 03	TR7	.09	1	\$5.60
111 05	TR8	.09	1	\$5.60
111 07	TR9	.09	1	\$5.60
111 09	TR10	.09	1	\$5.60
111 12	TR15	.09	1	\$5.60
111 15	TR20	.09	1	\$5.60
111 18	TR25	.09	1	\$5.60
111 20	TR27	.09	1	\$5.60
111 24	TR30	.11	1	\$5.60



**284 SYSTEM 6 TORX® Reversible Blade**, high alloy CVM steel, hardened, chrome plated, Wiha vapor Chrome-Top finish on tips. **TORX®** on 6mm SYSTEM 6 Hex. Blade length 175mm/6.89".

Item	Size	Size	lbs.	Each
284 51	T6 + T8		.08	\$7.40
284 52	T7 + T9		.08	\$7.40
284 53	T10 + T15		.08	\$7.40
284 54	T20 + T25		.08	\$7.40
284 55	T30 + T40		.09	\$7.40



**111 91 SYSTEM 6 Tamper Resistant TORX® Interchangeable Blade Set, 10 Pcs. in Durable Pouch.** Set includes ESD Safe Precision and Dynamic handles & 9 interchangeable blades.

Item	No.	lbs.	Each
	111 91	.84	\$53.98

Tamper Resistant: TR7, TR8, TR9, TR10, TR15, TR20, TR25, TR27, TR30  
ESD Safe Dynamic Handle



**107 91 SYSTEM 6/4 TORX® Interchangeable Blade Set, 9 Pcs. in Durable Pouch.** Set includes ESD Safe Precision and Dynamic handles and 7 Wiha interchangeable blades.

Item	No.	lbs.	Each
	107 91	.71	\$43.98

SYS 4: T5, T6, T7, T8, T9, T10, T15  
SYS 6: T20, T25, T30  
ESD Safe Precision & Dynamic Handle Set



## Wiha Topra Ratchet Handle

**282 Sets Topra Ratchet**

Pistol Grip Handle with ergonomic design has free running mechanism. Instant clutch engagement allows constant turning pressure on the fastener.



Item	Set Includes Topra Handle, Magnetic Bit Holder & The Following Bits:	lbs.
282 95	TORX® Sizes: T7, T8, T9, T10, T15, T20, T25, T27, T30, T40	.65
		Each \$45.88

Item	Tamper Resistant TORX® Sizes:	lbs.
282 97	TR7, TR8, TR9, TR10, TR15, TR20, TR25, TR27, TR30, TR40	.65
		Each \$51.98



Made in Germany

www.wihatools.com

Wiha Torx® ComfortGrip T-handle L-Keys



Through the handle side torque drive

Short and Long Arm In One Powerful Tool

Two Tools In One!

Two component soft grip handle

Maximum Comfort & Maximum Power

Torx - Blades of CVM tool steel, through hardened durability, satin chrome finish

CRM-72 - Blade chrome-vanadium-molybdenum tool steel, through hardened durability, hard chrome finish.



**364 ComfortGrip Torx T-handle** Blade CVM steel, through hardened, satin chrome finish. Soft grips are molded on and include through the handle side torque drive.

Item					
No.	Size	mm	lbs.	pkg.	Each
364 80	T10	100	1.05	10	\$5.60
364 81	T15	100	1.30	10	\$6.20
364 82	T20	100	1.64	10	\$7.00
364 83	T25	150	1.79	10	\$7.40
364 84	T27	150	2.08	10	\$8.30
364 86	T30	150	2.30	10	\$8.30
364 87	T40	150	2.54	10	\$8.90

**364 97 Set 7 Pcs. Torx® ComfortGrips** Blade CVM steel, hardened, chrome finish. Wiha soft grip T-handles are molded on and include through the handle side torque drive.

Item							
No.	Size	mm	mm	mm	mm	lbs.	
364 97	364 80	T10	100	364 84	T27	150	1.53
	364 81	T15	100	364 86	T30	150	
	364 82	T20	100	364 87	T40	150	Each
	364 83	T25	150				\$50.98

See Wiha Tools ComfortGrip T-handle L-keys in Hex Metric & Inch on Page 37



See More T-handles On Pages 21, 38 & 52



Made in Germany

Toll Free: (800) 494-6104

**Wiha TORX® T-handle**

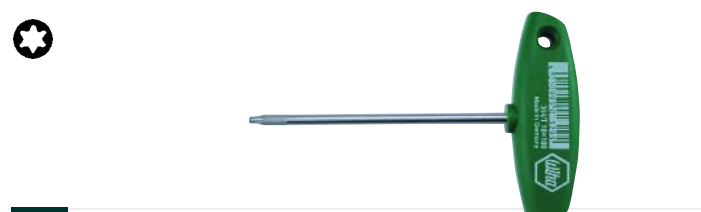

**364 TORX® Screwdriver, with Wiha-T-handle**  
Blade high alloy chrome-vanadium-molybdenum steel, hardened, chrome-plated. Wiha T-handle high quality plastic, impact resistant.

Item No.	Size	mm	Inch	mm	Inch	mm	Inch	lbs	pkg.	Each
364 09	T9	100	3.9	4.0	5/32	80	3.0	.07	10	\$4.50
364 10	T10	100	3.9	4.0	5/32	80	3.0	.07	10	\$4.70
364 15	T15	100	3.9	4.0	5/32	80	3.0	.07	10	\$5.40
364 17	T15	200	7.9	5.5	7/32	80	3.0	.13	10	\$5.40
364 20	T20	100	3.9	4.0	5/32	100	4.0	.10	10	\$6.10
364 22	T20	200	7.9	5.5	7/32	100	4.0	.17	10	\$6.10
364 25	T25	100	3.9	4.0	5/32	100	4.0	.11	10	\$6.40
364 27	T25	200	7.9	5.5	7/32	100	4.0	.17	10	\$6.40
364 30	T27	100	3.9	5.5	7/32	100	4.0	.14	10	\$7.30
364 32	T27	200	7.9	5.5	7/32	100	4.0	.17	10	\$7.30
364 35	T30	100	3.9	7.9	6.0	100	4.0	.14	10	\$7.20
364 37	T30	200	7.9	6.0	1/4	100	4.0	.19	10	\$7.30
364 40	T40	100	3.9	7.0	9/32	100	4.0	.16	10	\$7.90
364 42	T40	200	7.9	7.0	9/32	100	4.0	.23	10	\$8.00
364 45	T45	150	5.9	8.0	5/16	120	4.7	.29	10	\$9.70
364 52	T50	250	9.8	9.0	3/8	120	4.7	.45	10	\$11.90
364 55	T55	150	5.9	12.0	1/2	120	4.7	.50	10	\$14.50
364 60	T60	150	5.9	14.0	9/16	105	4.7	.61	10	\$17.10

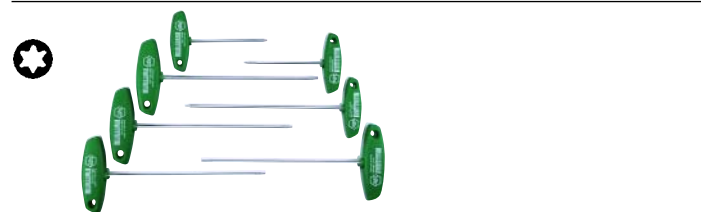

**364 92 Set 7 Pc. TORX® T-handle.**  
Blade CVM steel, hardened, chrome-plated.  
Wiha-T-handle high quality plastic, impact resistant.

Item No.	Size	mm	Size	mm	lbs.		
364 92	364 09	T9	100	364 27	T25	200	1.24
	364 10	T10	100	364 32	T27	200	
	364 17	T15	200	364 37	T30	200	Each
	364 22	T20	200				\$41.92

**364 90 TORX® Set in Metal Stand, 7 Pc. Set**  
Wiha T-handle includes TORX® sizes:  
T10, 15, 20, 25, 30 x 100mm  
T40 x 200mm, T50 x 250mm

Item No.	lbs.	pkg.	Each
364 90	2.65	1	\$59.98



**Wiha TORX® PocketStar**



**363 96 TORX® PocketStar Fold Outs, 7 Pc. Set**  
High alloy CVM steel, hardened, molded ergonomic handle.

Item No.	Size	Each
363 96	PocketStar	.22 \$13.24
Torx: T7, T8, T9, T10, T15, T20, T25		

**363 98 TORX® PocketStar Fold Outs, 8 Pc. Set**  
High alloy CVM steel, hardened, molded ergonomic handle.

Item No.	Size	Each
363 98	PocketStar	.24 \$16.38
Torx: T9, T10, T15, T20, T25, T27, T30, T40		

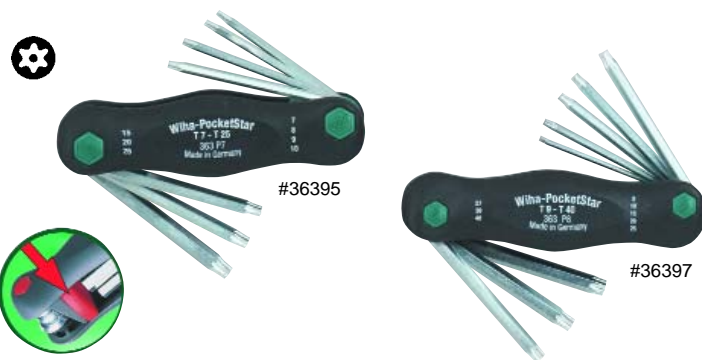

**363 95 Tamper Resistant TORX® PocketStar Fold Outs, 7 Pc. Set**  
High alloy CVM steel, hardened, molded ergonomic handle.

Item No.	Size	Each
363 95	PocketStar	.22 \$19.28
TR Torx: TR7, TR8, TR9, TR10, TR15, TR20, TR25		

**363 97 Tamper Resistant TORX® PocketStar Fold Outs, 8 Pc. Set**  
High alloy CVM steel, hardened, molded ergonomic handle.

Item No.	Size	Each
363 97	PocketStar	.24 \$23.40
TR Torx: TR9, TR10, TR15, TR20, R25, TR27, TR30, TR40		

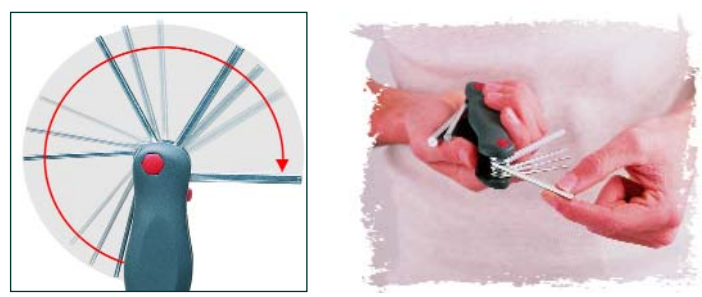



Made in Germany

www.wihatools.com

Wiha TORX® Tools



**365 TORX® Screwdriver, With Wing Handle**

Especially for use with indexable carbide tooling and also for working in confined spaces. Blade high alloy CVM steel, hardened, black finish. Wing handle high quality plastic, impact resistant.

Item	No.	Size	mm	Inch	mm	Inch	mm	Inch	lbs.	pkg.	Each
	365 10	T6	50	2.0	85	3.3	40	1.6	.02	10	\$3.10
	365 12	T7	50	2.0	85	3.3	40	1.6	.02	10	\$3.10
	365 15	T8	50	2.0	85	3.3	40	1.6	.02	10	\$3.10
	365 20	T9	50	2.0	85	3.3	40	1.6	.02	10	\$3.10
	365 25	T10	50	2.0	85	3.3	40	1.6	.02	10	\$3.10
	365 30	T15	50	2.0	85	3.3	40	1.6	.02	10	\$3.10
	365 35	T20	50	2.0	85	3.3	40	1.6	.02	10	\$3.10



**365 90 Wing Handle TORX® Set, 7 Pc. in Metal Stand**

Equipped with T6, T7, T8, T9, T10, T15, T20 **Each \$25.48**



**370 TORX® Screwdriver, With Flag Handle**

Especially for use with indexable carbide tooling and also for working in confined spaces. Blade high alloy CVM steel, hardened, black finish. Flag handle high quality plastic, impact resistant.

Item	No.	Size	mm	Inch	mm	Inch	mm	Inch	lbs.	pkg.	Each
	370 13	T5	35	1.38	67	2.64	19.0	.75	.01	10	\$2.90
	370 16	T6	35	1.38	67	2.64	19.0	.75	.01	10	\$2.90
	370 19	T7	35	1.38	67	2.64	19.0	.75	.01	10	\$2.90
	370 22	T8	40	1.58	72	2.84	19.0	.75	.01	10	\$2.90
	370 26	T9	40	1.58	73	2.89	23.5	.93	.01	10	\$2.90
	370 29	T10	40	1.58	73	2.89	23.5	.93	.01	10	\$2.90
	370 32	T15	45	1.77	80	3.15	28.0	1.10	.02	10	\$2.90
	370 36	T20	45	1.77	80	3.15	28.0	1.10	.02	10	\$2.90



**370 90 Flag Handle TORX® Set, 7 Pc. in Metal Stand**

Equipped with T6, T7, T8, T9, T10, T15, T20 **Each \$22.48**

Wiha TORX® Short Arm L-keys



**363 TORX® L-key, Short Arm**

High alloy chrome-vanadium-molybdenum steel, hardened, black finish.

Item	No.	Size	mm	Inch	mm	Inch	lbs.	pkg.	Each
	363 05	T5	36	1.4	16	.6	.01	10	\$1.66
	363 06	T6	38	1.5	16	.6	.01	10	\$1.66
	363 07	T7	41	1.6	16	.6	.01	10	\$1.66
	363 08	T8	44	1.7	16	.6	.01	10	\$1.66
	363 09	T9	48	1.9	16	.6	.01	10	\$1.66
	363 10	T10	51	2.0	17	.6	.01	10	\$1.66
	363 15	T15	54	2.1	18	.7	.01	10	\$1.66
	363 20	T20	57	2.2	19	.7	.01	10	\$1.66
	363 25	T25	60	2.3	20	.8	.02	10	\$1.66
	363 27	T27	64	2.5	21	.8	.03	10	\$1.66
	363 30	T30	70	2.7	24	.9	.05	10	\$2.34
	363 40	T40	76	2.9	26	1.0	.06	10	\$3.34
	363 45	T45	82	3.2	28	1.1	.09	10	\$4.26
	363 50	T50	95	3.7	32	1.2	.13	10	\$4.66
	363 55	T55	108	4.2	35	1.4	.27	10	\$6.10
	363 60	T60	120	4.7	38	1.5	.40	10	\$7.50



**363 92 TORX® Set, 7 Pc. in Plastic Holder**

Equipped with T6, T7, T8, T9, T10, T15, T20

Item	No.	lbs.	pkg.	Each
	363 92	.10	1	\$13.38

**363 94 TORX® Set, 9 Pc. in Plastic Holder**

Equipped with T8, T9, T10, T15, T20, T25, T27, T30, T40

Item	No.	lbs.	pkg.	Each
	363 94	.30	1	\$18.60



**363 90 TORX® Set, 9 Pc.**

In metal stand for TORX® keys, equipped with T10, T15, T20, T25, T30, T40, T50, T55, T60

Item	No.	lbs.	pkg.	Each
	363 90	2.34	1	\$43.88



Made in Germany

Toll Free: (800) 494-6104

Wiha TORX® Long Arm L-keys



**366 TORX® L-key, Long Arm**

High alloy chrome-vanadium-molybdenum steel, hardened, black finish.

Item No.	Size	mm	Inch	mm	Inch	lbs.	pkg.	Each
366 45	T5	72	2.8	13	.5	.06	10	\$2.80
366 46	T6	80	3.1	15	.6	.07	10	\$2.60
366 47	T7	88	3.4	18	.7	.10	10	\$2.10
366 48	T8	101	4.0	20	.8	.13	10	\$2.20
366 49	T9	111	4.3	21	.8	.17	10	\$2.30
366 50	T10	121	4.7	23	.9	.23	10	\$2.30
366 51	T15	136	5.3	27	1.1	.33	10	\$2.30
366 52	T20	148	5.8	29	1.1	.44	10	\$2.30
366 53	T25	163	6.4	33	1.3	.65	10	\$2.30
366 54	T27	170	6.7	36	1.4	.98	10	\$2.30
366 55	T30	178	7.0	38	1.5	1.27	10	\$3.10
366 59	T40	188	7.4	43	1.7	2.09	10	\$3.80
366 61	T50	200	7.8	50	2.0	3.14	10	\$4.60

Wiha Tamper Resistant TORX® L-keys



Tamper Resistant Torx L-Keys

**363 Tamper Resistant TORX® L-key, Short Arm**

High alloy CVM steel, hardened, black finish.

Item No.	Size	mm	Inch	mm	Inch	lbs.	pkg.	Each
363 21	TR7	41	1.6	16	.6	.01	10	\$2.30
363 23	TR8	44	1.7	16	.6	.01	10	\$2.30
363 26	TR9	48	1.9	16	.6	.01	10	\$2.30
363 28	TR10	51	2.0	17	.6	.01	10	\$2.30
363 29	TR15	54	2.1	18	.7	.01	10	\$2.30
363 32	TR20	57	2.2	19	.7	.02	10	\$2.30
363 35	TR25	60	2.4	20	.8	.02	10	\$2.30
363 37	TR27	68	2.7	21	.8	.03	10	\$2.60
363 39	TR30	70	2.7	24	.9	.04	10	\$3.10
363 42	TR40	76	3.0	26	1.0	.06	10	\$3.80
363 46	TR45	82	3.2	28	1.1	.09	10	\$5.66
363 52	TR50	95	3.7	32	1.2	.13	10	\$6.34
363 57	TR55	108	4.2	35	1.4	.27	10	\$9.64



**366 99 Long Arm TORX® Set, 13 Pc. in ProStar Holder**

Equipped with T5, T6, T7, T8, T9, T10, T15, T20, T25, T27, T30, T40, T50

Item No.	lbs.	pkg.	Each
366 99	1.13	1	\$34.98



Tamper Resistant Torx L-Key Set

**363 93 Tamper Resistant TORX® Set, 9 Pcs. in Plastic Holder**

Equipped with TR8, TR9, TR10, TR15, TR20, TR25, TR27, TR30, TR40

Item No.	lbs.	pkg.	Each
363 93	.30	1	\$23.20



ProStar Holder



www.wihatools.com

# The TORXPlus® Advantage

The TorxPlus® Drive System offers 100% improvement in driver bit fatigue & 25% average improvement in driver bit torsional strength. In addition its unique design provides optimum torque transfer and eliminates the need for excessive end load pressure while driving the fastener. The TorxPlus® configuration also virtually eliminates tool "camout" and slippage that can damage the head of the fastener and cause reduced tool life.

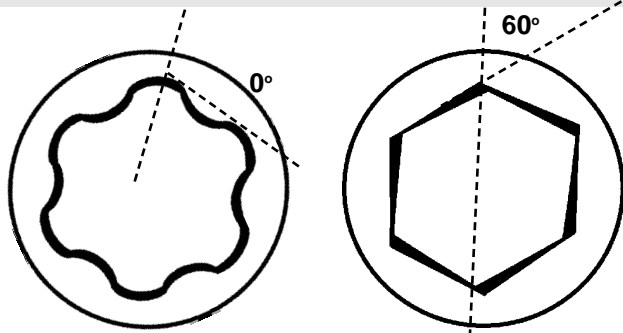

Not for use in standard Torx fasteners

- Broad Surface For Driving
- Features 0° Drive Angle Between The Fastener & Driver
- Greater Engagement Depth



**362 TORXPlus® Screwdriver With Wiha-SoftFinish Handle.** Round blade high alloy Chrome-vanadium-molybdenum tool steel, hardened, chrome-plated, Wiha-Chromtop finish on tips.

Item No.	Size	mm	Inch	mm	Inch	mm	Inch	lbs.	pkg.	Each
362 11	IP6	60	2.4	3.5	.139	164	6.5	.06	10	\$3.80
362 23	IP7	60	2.4	3.5	.139	164	6.5	.06	10	\$3.60
362 28	IP8	60	2.4	4.0	.157	171	6.7	.10	10	\$3.70
362 29	IP9	60	3.0	4.0	.157	171	6.7	.11	10	\$4.20
362 33	IP10	80	3.0	4.0	.157	191	7.5	.11	10	\$4.30
362 38	IP15	80	3.0	4.0	.157	191	7.5	.11	10	\$4.50
362 39	IP20	100	4.0	4.5	.177	211	8.3	.11	10	\$4.70
362 43	IP25	100	4.0	5.5	.216	211	8.3	.19	10	\$5.40
362 48	IP27	115	4.5	6.0	.236	233	9.2	.20	10	\$6.20
362 53	IP30	115	4.5	7.0	.275	233	9.2	.28	10	\$7.40
362 55	IP40	130	5.1	7.0	.275	254	10.0	.28	10	\$7.90



**362 99 Set 7 Pcs. TORXPlus®**

Blade high alloy CVM steel, hardened, chrome-plated.  
Wiha powerhandle cellulose-acetate, impact resistant.

Item No.	Size	mm	Size	mm	lbs.		
362 99	362 28	IP8	60	362 43	IP25	100	1.23
	362 33	IP10	80	362 53	IP30	115	
	362 38	IP15	80	362 55	IP40	130	Each
	362 39	IP20	100				\$37.90

## Wiha T-handle TORXPlus®



**364 TORXPlus® screwdriver, with Wiha-T-handle**

Blade high alloy chrome-vanadium-molybdenum steel, hardened, chrome-plated. Wiha T-handle high quality plastic, impact resistant.

Item No.	Size	mm	Inch	mm	Inch	mm	Inch	lbs	pkg.	Each
364 61	IP9	100	3.9	4.0	.157	80	3.0	.07	10	\$4.98
364 63	IP10	100	3.9	4.0	.157	80	3.0	.07	10	\$5.98
364 66	IP15	100	3.9	4.0	.157	80	3.0	.07	10	\$5.98
364 69	IP20	100	3.9	4.0	.157	80	3.0	.10	10	\$6.68
364 72	IP25	150	5.9	8.0	.315	120	4.7	.13	10	\$6.98
364 74	IP27	150	5.9	8.0	.315	120	4.7	.14	10	\$7.98
364 76	IP30	150	5.9	8.0	.315	120	4.7	.16	10	\$7.98
364 78	IP40	150	5.9	8.0	.315	120	4.7	.20	10	\$8.78



**364 96 Set 6 Pcs. TORXPlus® T-handles**

Blade CVM steel, hardened, chrome-plated. Chromtop blade tips.  
Wiha T-handle high quality plastic, impact resistant.

Item No.	Size	mm	Size	mm	lbs.		
364 96	364 63	IP10	100	364 72	IP25	150	1.01
	364 66	IP15	100	364 74	IP27	150	Each
	364 69	IP20	100	364 76	IP30	150	\$41.58





Made in Germany

Toll Free: (800) 494-6104

**TORXPlus®**

For Improved Torque and Longer Tool Life

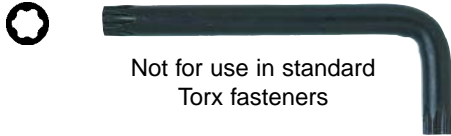

Not for use in standard Torx fasteners

**361 TORXPlus® L-key, Short Arm**  
High alloy chrome-vanadium-molybdenum steel, hardened, black finish.

Item No.	Size	mm	Inch	mm	Inch	lbs.	pkg.	Each
361 06	IP6	38	1.5	16	.6	.01	10	\$2.24
361 07	IP7	41	1.6	16	.6	.01	10	\$2.24
361 08	IP8	44	1.7	16	.6	.01	10	\$2.24
361 09	IP9	48	1.9	16	.6	.01	10	\$2.24
361 10	IP10	51	2.0	16	.6	.01	10	\$2.24
361 15	IP15	54	2.1	17	.6	.01	10	\$2.24
361 20	IP20	57	2.2	18	.7	.01	10	\$2.24
361 25	IP25	60	2.4	19	.7	.01	10	\$2.24
361 27	IP27	68	2.6	20	.8	.02	10	\$2.24
361 30	IP30	70	2.7	21	.8	.03	10	\$3.10
361 40	IP40	76	2.9	24	.9	.05	10	\$4.38



Not for use in standard Torx fasteners

**366 TORXPlus® L-key, Long Arm**  
High alloy chrome-vanadium-molybdenum steel, hardened, black finish.

Item No.	Size	mm	Inch	mm	Inch	lbs.	pkg.	Each
366 06	IP6	66	2.6	16	.6	.01	10	\$2.34
366 07	IP7	71	2.8	16	.6	.01	10	\$2.34
366 08	IP8	75	3.0	16	.6	.01	10	\$2.34
366 09	IP9	80	3.2	16	.6	.01	10	\$2.34
366 10	IP10	85	3.4	16	.6	.01	10	\$2.34
366 15	IP15	90	3.6	17	.6	.02	10	\$2.34
366 20	IP20	96	3.8	18	.7	.02	10	\$2.34
366 25	IP25	102	4.0	19	.7	.03	10	\$2.34
366 27	IP27	108	4.3	20	.8	.05	10	\$2.34
366 30	IP30	116	4.6	21	.8	.06	10	\$3.16
366 40	IP40	124	4.9	24	.9	.09	10	\$4.48



#36197



#36199

**361 97 TORXPlus® L-key, Short Arm 7 Pc. Set In Holder**  
High alloy chrome-vanadium-molybdenum steel, hardened, black finish.

Item No.	lbs.	pkg.	Set includes the following L-keys:	Each
361 97	.10	1	IP6, IP7, IP8, IP9, IP10, IP15, IP20	\$16.98

**361 99 TORXPlus® L-key, Short Arm 9 Pc. Set In Holder**  
Set includes the following L-keys:

Item No.	lbs.	pkg.	IP8, IP9, IP10, IP15, IP20, IP25, IP27, IP30, IP40	Each
361 99	.30	1		\$23.98

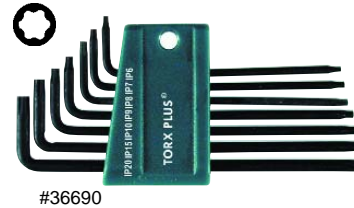

#36690

**366 90 TORXPlus® L-key, Long Arm 7 Pc. Set In Holder**  
High alloy chrome-vanadium-molybdenum steel, hardened, black finish.

Item No.	lbs.	pkg.	Set includes the following L-keys:	Each
366 90	.22	1	IP6, IP7, IP8, IP9, IP10, IP15, IP20	\$17.98

**366 91 TORXPlus® L-key, Long Arm 9 Pc. Set In Holder**  
Set includes the following L-keys:

Item No.	lbs.	pkg.	IP8, IP9, IP10, IP15, IP20, IP25, IP27, IP30, IP40	Each
366 91	.35	1		\$25.48

**TORXPlus®**

Not for use in standard Torx fasteners



**365 TORXPlus® Screwdriver, With Wing Handle**  
Especially for use with indexable carbide tooling and also for working in confined spaces. Blade high alloy CVM steel, hardened, black finish. Wing handle high quality plastic, impact resistant.

Item No.	Size	mm	Inch	mm	Inch	mm	Inch	lbs.	pkg.	Each
365 40	IP5	50	2.0	85	3.3	40	1.6	.02	10	\$3.30
365 42	IP6	50	2.0	85	3.3	40	1.6	.02	10	\$3.30
365 44	IP7	50	2.0	85	3.3	40	1.6	.02	10	\$3.30
365 46	IP8	50	2.0	85	3.3	40	1.6	.02	10	\$3.30
365 48	IP9	50	2.0	85	3.3	40	1.6	.02	10	\$3.70
365 50	IP10	50	2.0	85	3.3	40	1.6	.02	10	\$3.70
365 52	IP15	50	2.0	85	3.3	40	1.6	.02	10	\$3.90
365 54	IP20	50	2.0	85	3.3	40	1.6	.02	10	\$4.30



**365 92 TORXPlus® 7 Pcs. Wing Handle Set in metal stand**  
Equipped with IP6, IP7, IP8, IP9, IP10, IP15, IP20

Item No.	lbs.	pkg.	Each
365 92	.38	1	\$33.98





Made in Germany

Toll Free: (800) 494-6104

Wiha Adjustable TorqueControl Tools

Wiha TorqueControl Screwdrivers

TorqueFix™ & TorqueVario™ ergonomic cushion grip two component handles allow for maximum achievable torque to be reached.

Quality and repeatability - each TorqueFix & TorqueVario tool is tested and complies with:

- EN ISO 6789
- BS EN 26789
- ASME B107.14M

Each tool has unique serial number and certificate of calibration

Whether it's TorqueVario-S, TorqueVario or TorqueFix - Wiha has a torque screwdriver to cover almost every application



Cushion grips for maximum user comfort

Four handle sizes optimized to match torque settings

Audible & perceptible click alerts user that torque level has been attained

Precise torque for service, assembly, tooling & repair

Loosening torque 50% greater than the tightening torque

+/-6% accuracy tolerance



Includes Certificate & Micro Bit Holder 28583

285 TorqueFix, With Wiha-SoftFinish® Handle

Fixed Torque value pre-set. Tested in accordance with EN ISO 6798, BS EN 26789, ASME B107.14M, tolerance +/- 6%. Audible and perceptible click when pre-set torque has been attained. Wiha-SoftFinish® handle, multi-component. 50% greater reverse torque.

Item No.	Pre-Sets		Torque					Each
	oz.	lbs.	Nm	mm	Inch	lbs.	pkg.	
285 03	80	5	0.56	112	4.4	.16	1	\$69.98
285 05	120	7.5	0.84	112	4.4	.15	1	\$69.98
285 07	160	10	1.12	119	4.7	.28	1	\$79.98
285 09	200	12.5	1.41	119	4.7	.27	1	\$79.98
285 11	240	15	1.69	119	4.7	.27	1	\$79.98
285 13	320	20	2.25	119	4.7	.28	1	\$79.98
285 15	400	25	2.82	126	4.9	.37	1	\$79.98
285 17	480	30	3.39	126	4.9	.37	1	\$79.98
285 18	560	35	3.95	126	4.9	.37	1	\$89.98
285 19	640	40	4.52	126	4.9	.37	1	\$89.98
285 21	800	50	5.65	132	5.2	.52	1	\$89.98
285 23	960	60	6.78	132	5.2	.52	1	\$89.98
285 25	1120	70	7.91	132	5.2	.52	1	\$89.98

285 TorqueVario-S Handle, With Window Scale & 4mm Bit Holder

EN ISO 6798, BS EN 26789, ASME B107.14M. Ergonomic multi-component handle, light and compact. Handle sizes proportioned to optimize torque range. Audible and perceptible click when the torque setting has been attained. Includes Micro Bit Holder 28583

Item No.	Range		Torque		Each		
	Inch	lbs.	mm	pkg.			
285 01	15 - 80	(in/oz)	2.5	Inch oz	122 - 127	1	\$89.98
285 02	5 - 10		.2	Inch lbs	122 - 127	1	\$89.98
285 04	7.5 - 20		.5	Inch lbs	126 - 131	1	\$99.98
285 06	10 - 50		2	Inch lbs	133 - 138	1	\$102.98
285 08	20 - 70		2	Inch lbs	137 - 142	1	\$109.98

See 4mm Micro Bits on Page 127-128



Includes Certificate

285 TorqueVario-S Handle, With Newton Meter Scale

EN ISO 6798, BS EN 26789, ASME B107.14M. Ergonomic multi-component handle, light and compact. Handle sizes proportioned to optimize torque range. Audible and perceptible click when the torque setting has been attained.

Item No.	Newton		Torque		Each
	Meter Scale	Increments	mm	pkg.	
285 50	0.1 - 0.6Nm	.02 Nm	122 - 127	1	\$99.98
285 51	0.4 - 1.0Nm	.05 Nm	122 - 127	1	\$99.98
285 52	0.8 - 2.0Nm	.05 Nm	126 - 131	1	\$109.98
285 53	1.0 - 5.0Nm	.20 Nm	133 - 138	1	\$112.98
285 54	2.0 - 8.0Nm	.25 Nm	137 - 142	1	\$119.98



Made in Germany

www.wihatools.com

**Wiha Adjustable TorqueControl Tool Sets**



With Certificate  
of Calibration

**285 90 Set 24 Piece TorqueVario-S Micro-Bit Set**

Certified to EN ISO 6798, BS EN 26789, ASME B107.14M. Set includes Ergonomic multi-component Adjustable TorqueVario-S Handle, 21 Micro Bits, Micro Bit Holder and Torque adjustment tool. Packed in a compact durable steel storage box.

Item No.		
285 90	Slotted: 1.5, 2.0, 3.0, 4.0mm Phillips: #00, #0, #1 Torx: T6, T7, T8, T9, T10, T15 Hex Inch: .050, 1/16, 5/64, 3/32, 7/64, 1/8, 9/64, 5/32 28504 Handle Range 7.5 - 20 Inch lbs.	lbs. 1.33 Each \$149.98



**51 Piece Set**



With Certificate  
of Calibration

**285 95 Set 51 Piece TorqueVario-S Bit Set In Metal Box**

Certified to EN ISO 6798, BS EN 26789, ASME B107.14M. Set includes Ergonomic multi-component Adjustable TorqueVario-S Handle, 48 Insert Bits, 1/4" Bit Holder and Torque adjustment tool.

Item No.		
285 95	Slotted: 4.5, 5.5, 6.5, 8.0mm Phillips: #0, #1, #2, #3 Torx: T6, T7, T8, T9, T10, T15, T20, T25 Hex Inch: 1/16, 5/64, 3/32, 7/64, 1/8, 9/64, 5/32, 3/16" Hex Metric: 1.5, 2.0, 2.5, 3.0, 4.0, 5.0, 6.0, 8.0mm Pozidriv: #0, #1, #2, #3 Torq Set: #4, #5, #6, #8 Square: #1, #2, #3 Triwing: #0, #1, #2, #3, #4 28506 Handle Range 10 - 50 Inch lbs. 28581 1/4" Bit Holder	lbs. 2.85 Each \$195.98

**Wiha TorqueControl Adapters**

**Adapters For TorqueFix™ & TorqueVario™**



**285 Bit Holder Adapter For 1/4" Drive Bits**

Shaft CVM steel, hardened, corrosion protected.

Item No.	Size	mm	mm	lbs.	pkg.	Each
285 81	1/4	149	4.0	.09	1	\$6.98

See pages  
155-165  
for Insert bits



**285 Square Drive Adapter For 1/4" Sockets**

Shaft CVM steel, hardened, corrosion protected.

Item No.	Size	mm	mm	lbs.	pkg.	Each
285 82	1/4	145	4.0	.08	1	\$6.98

See pages  
167-169  
for Sockets



**285 Adapter Blade For Wiha 4 mm MicroBits**

Shaft CVM steel, hardened, corrosion protected.

Item No.	Size	mm	mm	lbs.	pkg.	Each
285 83	4.0	149	4.0	.09	1	\$6.98

See pages  
127-128  
for Micro bits



Made in Germany

Toll Free: (800) 494-6104

Wiha TorqueControl Blades



**285 Slotted Interchangeable Blades For TorqueFix & TorqueVario**

Slotted tip blades on narrow 5/32 Hex shafts. High alloy chrome-vanadium-molybdenum steel, hardened, satin hard chrome finish.

Item						
No.	mm	Inch	mm	lbs.	pkg.	Each
285 34	1.5	.059	175	.07	1	\$4.30
285 35	2.0	.078	175	.07	1	\$4.30
285 36	2.5	.098	175	.07	1	\$4.30
285 37	3.0	.118	175	.07	1	\$4.30
285 38	3.5	.139	175	.07	1	\$4.30
285 39	4.0	.157	175	.07	1	\$4.30



**285 TORX® Plus® Blades For TorqueFix & TorqueVario**

TORX® Plus® tip blades on narrow 5/32 Hex shafts. High alloy chrome-vanadium-molybdenum steel, hardened, satin hard chrome finish.

Item						
No.	Size	mm	mm	lbs.	pkg.	Each
285 71	IP5	175	4.0	.07	1	\$4.30
285 72	IP6	175	4.0	.07	1	\$4.30
285 73	IP7	175	4.0	.07	1	\$4.30
285 74	IP8	175	4.0	.07	1	\$4.30
285 75	IP9	175	4.0	.07	1	\$4.30
285 76	IP10	175	4.0	.07	1	\$4.30
285 77	IP15	175	4.0	.07	1	\$4.30
285 78	IP20	175	4.0	.07	1	\$4.30
285 79	IP25	175	4.0	.07	1	\$4.30



**285 Phillips Interchangeable Blades For TorqueFix & TorqueVario**

Phillips tip blades on narrow 5/32 Hex shafts. High alloy chrome-vanadium-molybdenum steel, hardened, satin hard chrome finish.

Item						
No.	mm	mm	mm	lbs.	pkg.	Each
285 40	000	175	4.0	.07	1	\$4.30
285 41	00	175	4.0	.07	1	\$4.30
285 42	0	175	4.0	.07	1	\$4.30
285 43	1	175	4.0	.07	1	\$4.30



**285 Hex Metric Interchangeable Blades For TorqueFix & TorqueVario**

Slotted tip blades on narrow 5/32 Hex shafts. High alloy CVM steel, hardened, satin hard chrome finish.

Item						
No.	mm	mm	lbs.	pkg.	Each	
285 45	1.5	175	.07	1	\$4.30	
285 46	2.0	175	.07	1	\$4.30	
285 47	2.5	175	.07	1	\$4.30	
285 48	3.0	175	.07	1	\$4.30	
285 49	4.0	175	.07	1	\$4.30	



**285 TORX® Interchangeable Blades For TorqueFix & TorqueVario**

TORX® tip blades on narrow 5/32 Hex shafts. High alloy chrome-vanadium-molybdenum steel, hardened, satin hard chrome finish.

Item						
No.	Size	mm	mm	lbs.	pkg.	Each
285 61	T5	175	4.0	.07	1	\$4.30
285 62	T6	175	4.0	.07	1	\$4.30
285 63	T7	175	4.0	.07	1	\$4.30
285 64	T8	175	4.0	.07	1	\$4.30
285 65	T9	175	4.0	.07	1	\$4.30
285 66	T10	175	4.0	.07	1	\$4.30
285 67	T15	175	4.0	.07	1	\$4.30
285 68	T20	175	4.0	.07	1	\$4.30
285 69	T25	175	4.0	.07	1	\$4.30



**285 Hex Inch Interchangeable Blades For TorqueFix & TorqueVario**

Slotted tip blades on narrow 5/32 Hex shafts. High alloy CVM steel, hardened, satin hard chrome finish.

Item						
No.	Inch	mm	lbs.	pkg.	Each	
285 55	.050	175	.07	1	\$4.30	
285 56	1/16	175	.07	1	\$4.30	
285 57	5/64	175	.07	1	\$4.30	
285 58	3/32	175	.07	1	\$4.30	
285 59	7/64	175	.07	1	\$4.30	
285 60	1/8	175	.07	1	\$4.30	
285 87	9/64	175	.07	1	\$4.30	
285 88	5/32	175	.07	1	\$4.30	

\* None of the blades featured on this page will function in a TorqueVario Insulated Handle



Made in Germany

www.wihatools.com

**Wiha Insulated TorqueControl Tools**



**1000V**

Includes Certificate

**285 Insulated TorqueVario-S, With Window Scale Insulation**  
According to ASTM F-1505-01, New VDE Specification 0682/part 201 and IEC 900, up to 1000 Volt. "GS" Sign. Individually Tested. EN ISO 6798, BS EN 26789, ASME B107.14M, +/- 6% Accuracy Ergonomic multi-component handle, light and compact. Handle sizes proportioned to optimize torque range. Audible and perceptible click when torque setting has been attained. Includes Certificate

Item No.	Range	Inch lbs.	Increments	mm	pkg.	Each
285 14	7.5 - 20	.5 Inch lbs	126 - 131	1		\$127.98
285 16	10 - 50	2 Inch lbs	133 - 138	1		\$131.98
285 20	20 - 70	2 Inch lbs	137 - 142	1		\$141.98

Each TorqueVario handle has unique serial number and certificate of calibration



**287 Insulated Slotted Interchangeable Blades For TorqueVario-S**  
Slotted tip blades on narrow 5/32 Hex shafts. High alloy chrome-vanadium-molybdenum tool steel, hardened.

Item No.	mm	Inch	mm	lbs.	pkg.	Each
287 01	3.0	.118	190	.07	1	\$5.70
287 03	3.5	.139	190	.07	1	\$5.70
287 05	4.0	.157	190	.07	1	\$5.70
287 07	5.5	.216	190	.07	1	\$5.70

These Insulated Blades work in Insulated handles only



**287 Insulated Phillips Interchangeable Blades For TorqueVario-S**  
Phillips tip blades on narrow 5/32 Hex shafts. High alloy chrome-vanadium-molybdenum tool steel, hardened.

Item No.	Size	mm	mm	lbs.	pkg.	Each
287 10	00	190	4.0	.07	1	\$5.70
287 11	0	190	4.0	.07	1	\$5.70
287 12	1	190	4.0	.07	1	\$5.70

These Insulated Blades work in Insulated handles only

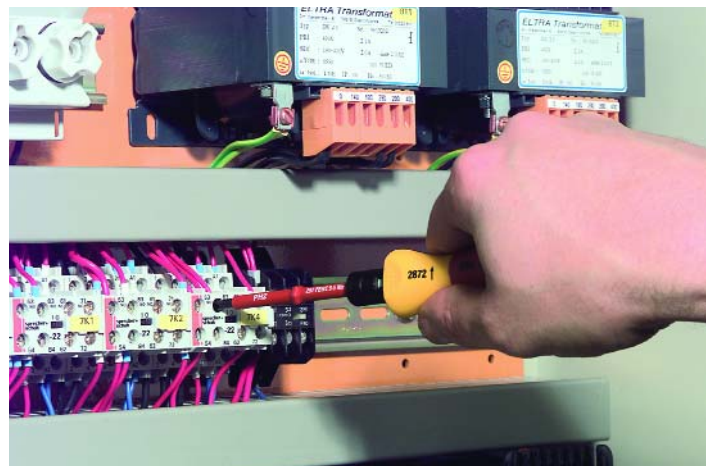

See Insulated Pliers/Cutters & Screwdrivers On Pages 81-91



Made in Germany

Toll Free: (800) 494-6104

**ESD Safe Adjustable TorqueControl Tools**



Includes Certificate

**285 ESD Safe TorqueVario-S, With Window Scale**  
 EN ISO 6798, BS EN 26789, ASME B107.14M, +/- 6% Accuracy  
 Ergonomic multi-component handle, light and compact. Handle sizes proportioned to optimize torque range. Audible and perceptible click when torque setting has been attained. With Certificate of accuracy.

Item No.	Range	Inch lbs.	Increments	mm	pkg.	Each
285 22	15 - 80(in/oz)	2.5 Inch oz	122 - 127	1	\$110.98	
285 24	5 - 10	.2 Inch lbs	122 - 127	1	\$111.98	
285 26	7.5 - 20	.5 Inch lbs	126 - 131	1	\$123.98	

Each TorqueVario handle has unique serial number and certificate of calibration



With Certificate of Calibration

**285 92 Set 24 Pcs. ESD Safe Adjustable TorqueVario-S Bit Set**  
 Certified to EN ISO 6798, BS EN 26789, ASME B107.14M. Set includes Ergonomic multi-component Adjustable TorqueVario-S Handle, 21 Micro Bits, Micro Bit Holder, and Torque adjustment tool, packed in a compact durable steel storage box.

Item No.	Slotted: 1.5, 2.0, 3.0, 4.0mm	Phillips: #00, #0, #1	Torx: T6, T7, T8, T9, T10, T15	Hex Inch: .050, 1/16, 5/64, 3/32, 7/64, 1/8, 9/64, 5/32	28526 Handle ESD Safe Range 7.5 - 20 Inch lbs.	Each
285 92						\$164.98

See ESD Safe Tools  
 On Pages 68, 76, 104-112, 131-133



**288 ESD Safe Slotted Interchangeable Blades For TorqueVario-S**  
 Slotted tip blades on narrow 5/32 Hex shafts. High alloy chrome-vanadium-molybdenum steel, hardened, satin hard chrome finish.

Item No.	mm	Inch	mm	lbs.	pkg.	Each
288 01	1.5	.059	175	.07	1	\$5.20
288 03	2.0	.078	175	.07	1	\$5.20
288 05	3.0	.118	175	.07	1	\$5.20
288 07	3.5	.139	175	.07	1	\$5.20
288 09	4.0	.157	175	.07	1	\$5.20



**288 ESD Safe Phillips Interchangeable Blades For TorqueVario-S**  
 Phillips tip blades on narrow 5/32 Hex shafts. High alloy chrome-vanadium-molybdenum steel, hardened, satin hard chrome finish.

Item No.	Size	mm	mm	lbs.	pkg.	Each
288 10	000	175	4.0	.07	1	\$5.20
288 12	00	175	4.0	.07	1	\$5.20
288 14	0	175	4.0	.07	1	\$5.20
288 16	1	175	4.0	.07	1	\$5.20



**288 ESD Safe TORX Interchangeable Blades For TorqueVario-S**  
**TORX** tip blades on narrow 5/32 Hex shafts. High alloy chrome-vanadium-molybdenum steel, hardened, chrome-plated.

Item No.	Size	mm	mm	lbs.	pkg.	Each
288 25	T5	175	4.0	.07	1	\$5.20
288 26	T6	175	4.0	.07	1	\$5.20
288 27	T7	175	4.0	.07	1	\$5.20
288 28	T8	175	4.0	.07	1	\$5.20
288 29	T9	175	4.0	.07	1	\$5.20
288 30	T10	175	4.0	.07	1	\$5.20

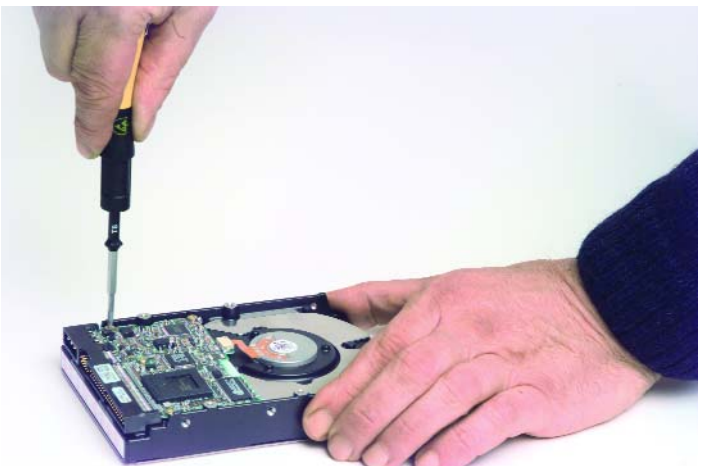







Made in Germany

Toll Free: (800) 494-6104

**MagicRing Ball End Hex Keys**



**Ball End Hex Keys**  
Chamfered ends for easy insertion

**Ball End Hex Keys**  
CVM steel, hardened, chrome-plated, screw holding

**ProStar Holder (9-13 pc. Sets)**  
Sliding front detachable

**ProStar Holder**  
Every key can be taken out separately without having to move another key.

U.S. Patent 6,302,001 B1

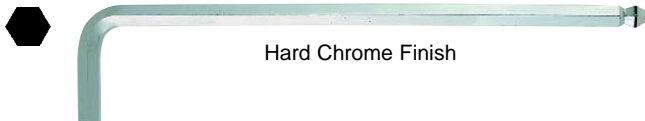

**669 MagicRing Ball End Metric Hex L-Key, Long**

Blade CVM steel, hardened, chrome-plated.

Item No.	mm	mm	mm	lbs.	pkg.	Each	
669 04*	1.5	89	14	.004	10	\$1.08	No Ring
669 08*	2.0	99	16	.007	10	\$1.08	No Ring
669 12*	2.5	111	18	.012	10	\$1.08	No Ring
<b>MagicRing</b>							
669 16	3.0	125	20	.019	10	\$2.60	
669 20	4.0	138	25	.042	10	\$2.66	
669 24	5.0	158	28	.072	10	\$2.86	
669 28	6.0	178	32	.12	10	\$3.32	
669 36	8.0	198	36	.23	10	\$4.68	
669 44	10.0	221	40	.40	10	\$6.02	

\* Standard Ball - No Ring



Hard Chrome Finish

**669 90 9 Pc. MagicRing Long Metric Ball End Hex L-Key Set in ProStar Holder**

Blade CVM steel, hardened, chrome-plated.

Item No.	mm	mm	mm	mm	mm	lbs.	Each
669 90	669 04*	1.5	89	669 24	5.0	158	1.07
	669 08*	2.0	99	669 28	6.0	178	
	669 12*	2.5	111	669 36	8.0	198	
	669 16	3.0	125	669 44	10.0	221	Each
	669 20	4.0	138				\$26.26

\* Standard ball - No Ring

**Screw Holding Hex Tools!**

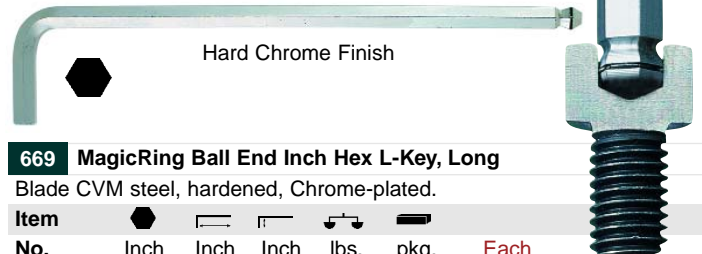

**669 MagicRing Ball End Inch Hex L-Key, Long**

Blade CVM steel, hardened, Chrome-plated.

Item No.	Inch	Inch	Inch	lbs.	pkg.	Each	
669 45*	.050	2.78	.470	.002	10	\$1.08	No Ring
669 46*	1/16	3.05	.549	.004	10	\$1.08	No Ring
669 47*	5/64	3.37	.627	.007	10	\$1.08	No Ring
669 50*	3/32	3.84	.705	.010	10	\$1.08	No Ring
669 52*	7/64	3.92	.784	.016	10	\$1.08	No Ring
<b>MagicRing</b>							
669 53	1/8	4.62	.784	.021	10	\$2.66	
669 55	9/64	5.17	.901	.029	10	\$2.66	
669 56	5/32	5.64	.980	.035	10	\$2.66	
669 59	3/16	6.19	1.01	.059	10	\$2.66	
669 62	7/32	6.43	1.13	.092	10	\$2.86	
669 65	1/4	6.74	1.21	.13	10	\$3.06	
669 68	5/16	7.09	1.41	.22	10	\$4.68	
669 71	3/8	7.49	1.49	.36	10	\$6.00	

\* Standard Ball - No Ring



Hard Chrome Finish

**669 91 13 Pc. MagicRing Long Inch Ball End Hex L-Key Set in ProStar Holder**

Blade CVM steel, hardened, chrome-plated.

Item No.	Inch	Inch	Inch	Inch	lbs.	Each	
669 91	669 45*	.050	2.78	669 56	5/32	5.64	1.14
	669 46*	1/16	3.05	669 59	3/16	6.19	
	669 47*	5/64	3.37	669 62	7/32	6.43	
	669 50*	3/32	3.84	669 65	1/4	6.74	
	669 52*	7/64	3.92	669 68	5/16	7.09	
	669 53	1/8	4.62	669 71	3/8	7.49	Each
	669 55	9/64	5.17				\$32.98

\* Standard Ball - No Ring

**669 92 22 Pc. Combination MagicRing L-key Set In ProStar Holder**

Blade CVM steel, hardened, chrome-plated.

Item No.	lbs.	Each	
669 92	Set includes:	2.21	\$53.98
	66990 Set - 1.5*, 2.0*, 2.5*, 3.0, 4.0, 5.0, 6.0, 8.0, 10.0mm		
	66991 Set - .050*, 1/16*, 5/64*, 3/32*, 7/64*, 1/8, 9/64, 5/32, 3/16, 7/32, 1/4, 5/16, 3/8"		

\* Standard Ball - No Ring



Made in Germany

www.wihatools.com

**Metric Ball End Hex Keys Black Finish**

**Ball End Hex Keys**  
Chamfered ends for easy insertion

**Ball End Hex Keys**  
Working angle up to 30°

**Ball End Hex Keys**  
Chrome-vanadium-molybdenum steel, hardened, black finish

**ProStar Holder (9-13 pc. Sets)**  
Sliding front detachable

**ProStar Holder**  
Every key can be taken out separately without having to move another key.

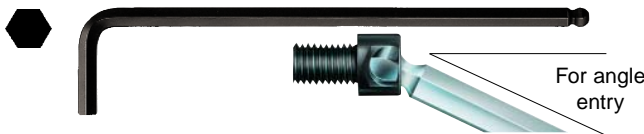

**369 Ball End Metric Hex L-Key, Long**

Blade CVM steel, hardened, black finish.

Item							
No.	mm	mm	mm	lbs.	pkg.	Each	
369 04	1.5	89	14	.004	10	\$ .74	
369 08	2.0	99	16	.007	10	\$ .74	
369 12	2.5	111	18	.012	10	\$ .80	
369 16	3.0	125	20	.019	10	\$ .90	
369 20	4.0	138	25	.042	10	\$ .94	
369 24	5.0	158	28	.072	10	\$ 1.22	
369 28	6.0	178	32	.12	10	\$ 1.64	
369 36	8.0	198	36	.23	10	\$ 2.60	
369 44	10.0	221	40	.40	10	\$ 3.80	



**369 90 9 Pc. Metric Ball End Long Hex L-Key Set in ProStar Holder**

Blade chrome-vanadium-molybdenum steel, hardened, black finish.

Item							
No.	mm	mm	mm	mm	mm	lbs.	
369 90	369 04	1.5	89	369 24	5.0	158	.95
	369 08	2.0	99	369 28	6.0	178	
	369 12	2.5	111	369 36	8.0	198	
	369 16	3.0	125	369 44	10.0	221	Each
	369 20	4.0	138				\$ 11.98



**369 92 Set 6 Pc. Metric Ball End Long Hex L-Key Set**

Blade chrome-vanadium-molybdenum steel, hardened, black finish.

Item							
No.	Inch	mm	mm	Inch	mm	mm	lbs.
369 92	369 04	1.5	89	369 16	3.0	125	.30
	369 08	2.0	99	369 20	4.0	138	Each
	369 12	2.5	111	369 24	5.0	158	\$ 6.28

**Metric Ball End Hex Keys Chrome Finish**

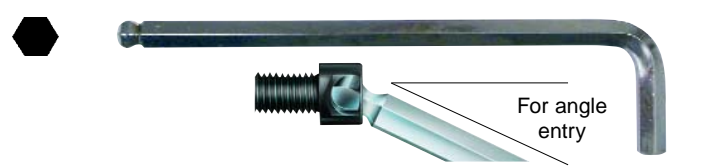

**669 Ball End Metric Hex L-Key, Long**

Blade CVM steel, hardened, chrome finish.

Item							
No.	mm	mm	mm	lbs.	pkg.	Each	
669 04	1.5	89	14	.004	10	\$ 1.08	
669 08	2.0	99	16	.007	10	\$ 1.08	
669 12	2.5	111	18	.012	10	\$ 1.08	
669 18	3.0	125	20	.019	10	\$ 1.08	
669 22	4.0	138	25	.042	10	\$ 1.40	
669 26	5.0	158	28	.072	10	\$ 1.50	
669 30	6.0	178	32	.12	10	\$ 2.04	
669 37	8.0	198	36	.23	10	\$ 3.36	
669 38	10.0	221	40	.40	10	\$ 4.50	



**669 94 9 Pc. Metric Ball End Long Hex L-Key Set**

Blade chrome-vanadium-molybdenum steel, hardened, chrome finish.

Item							
No.	mm	mm	mm	mm	mm	lbs.	
669 94	669 04	1.5	89	669 26	5.0	158	.98
	669 08	2.0	99	669 30	6.0	178	
	669 12	2.5	111	669 37	8.0	198	
	669 18	3.0	125	669 38	10.0	221	Each
	669 22	4.0	138				\$ 16.58



**669 95 Set 6 Pc. Metric Ball End Long Hex L-Key Set**

Blade chrome-vanadium-molybdenum steel, hardened, chrome finish.

Item							
No.	mm	mm	mm	mm	mm	lbs.	
669 95	669 04	1.5	89	669 18	3.0	125	.21
	669 08	2.0	99	669 22	4.0	138	Each
	669 12	2.5	111	669 26	5.0	158	\$ 7.54



Made in Germany

Toll Free: (800) 494-6104

**Inch Ball End Hex Keys Black Finish**

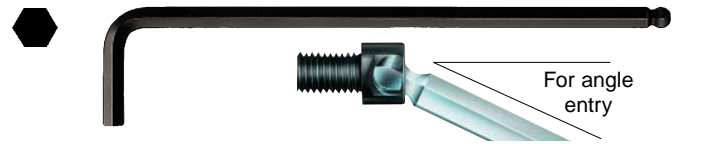

**369 Ball End Inch Hex L-Key, Long Arm**  
Blade CVM steel, hardened, black finish.

Item No.	Inch	Inch	Inch	lbs.	pkg.	Each
369 45	.050	2.78	.470	.002	10	\$.74
369 46	1/16	3.05	.549	.004	10	\$.74
369 47	5/64	3.37	.629	.007	10	\$.74
369 50	3/32	3.84	.705	.010	10	\$.78
369 52	7/64	3.92	.784	.016	10	\$.88
369 53	1/8	4.62	.784	.021	10	\$.88
369 55	9/64	5.17	.901	.029	10	\$.92
369 56	5/32	5.64	.980	.035	10	\$.96
369 59	3/16	6.19	1.01	.059	10	\$1.10
369 62	7/32	6.43	1.13	.092	10	\$1.34
369 65	1/4	6.74	1.21	.13	10	\$1.54
369 68	5/16	7.09	1.41	.22	10	\$2.44
369 71	3/8	7.49	1.49	.36	10	\$3.42

**Inch Ball End Hex Keys Chrome Finish**

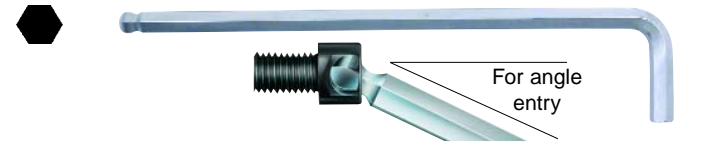

**369 Ball End Inch Hex L-Key, Long Arm**  
Blade CVM steel, hardened, chrome finish.

Item No.	Inch	Inch	Inch	lbs.	pkg.	Each
369 40	.050	2.78	.470	.002	10	\$1.24
369 41	1/16	3.05	.549	.004	10	\$1.26
369 42	5/64	3.37	.629	.007	10	\$1.26
369 43	3/32	3.84	.705	.010	10	\$1.28
369 48	7/64	3.92	.784	.016	10	\$1.58
369 49	1/8	4.62	.784	.021	10	\$1.62
369 51	9/64	5.17	.901	.029	10	\$1.64
369 54	5/32	5.64	.980	.035	10	\$1.72
369 57	3/16	6.19	1.01	.059	10	\$1.88
369 58	7/32	6.43	1.13	.092	10	\$2.28
369 60	1/4	6.74	1.21	.13	10	\$2.44
369 61	5/16	7.09	1.41	.22	10	\$3.20
369 63	3/8	7.49	1.49	.36	10	\$4.34



**369 91 13 Pc. Inch Ball End Long Hex L-Key Set in ProStar Holder**  
Blade chrome-vanadium-molybdenum steel, hardened, black finish.

Item No.	Inch	Inch	Inch	Inch	lbs.
369 91	369 45	.050	2.78	369 56	5/32 5.64
	369 46	1/16	3.05	369 59	3/16 6.19
	369 47	5/64	3.37	369 62	7/32 6.43
	369 50	3/32	3.84	369 65	1/4 6.74
	369 52	7/64	3.92	369 68	5/16 7.09
	369 53	1/8	4.62	369 71	3/8 7.49
	369 55	9/64	5.17		
					Each \$14.48



**369 98 13 Pc. Inch Ball End Long Hex L-Key Set in ProStar Holder**  
Blade chrome-vanadium-molybdenum steel, hardened, chrome finish.

Item No.	Inch	Inch	Inch	Inch	lbs.
369 98	369 40	.050	2.83	369 54	5/32 5.83
	369 41	1/16	3.15	369 57	3/16 6.42
	369 42	5/64	3.46	369 58	7/32 6.69
	369 43	3/32	3.98	369 60	1/4 7.01
	369 48	7/64	4.37	369 61	5/16 7.44
	369 49	1/8	4.76	369 63	3/8 7.87
	369 51	9/64	5.35		
					Each \$23.98



**369 93 Set 8 Pc. Inch Ball End Long Hex L-Key Set**  
Blade chrome-vanadium-molybdenum steel, hardened, black finish.

Item No.	Inch	mm	Inch	mm	lbs.
369 93	369 47	5/64	86	369 59	3/16 158
	369 50	3/32	98	369 62	7/32 164
	369 53	1/8	118	369 65	1/4 172
	369 56	5/32	144	369 68	5/16 181
					Each \$10.48



Made in Germany

www.wihatools.com

Wiha MagicRing T-handle

Screw Holding Hex Tools

Hole for hanging

Proportioned Ergonomic handle designed for high torque

Handle is molded directly onto blade

Smooth edges prevent injuries & eliminate pressure marks

Blade CVM tool steel, hardened, chrome-plated

**540 MagicRing Ball End, With Wiha T-handle** Blade CVM steel, hardened, chrome-plated. Ball end for easy insertion. Wiha T-handle high quality plastic, impact resistant.

Item No.	mm	mm	mm	mm	Inch	lbs.	pkg.	Each
540 40	4.0	150	80	176	6.9	.08	10	\$3.10
540 50	5.0	150	100	182	7.1	.14	10	\$3.90
540 60	6.0	150	100	182	7.1	.17	10	\$4.70
540 80	8.0	200	100	232	9.1	.29	10	\$6.20
540 86	10.0	200	120	238	9.3	.49	10	\$8.10

**540 MagicRing Ball End, With Wiha T-handle** Blade CVM steel, hardened, chrome-plated. Ball end for easy insertion. Wiha T-handle high quality plastic, impact resistant.

Item No.	Inch	Inch	Inch	Inch	lbs.	pkg.	Each
540 12	5/32	5.8	2.8	6.9	.08	10	\$3.10
540 14	3/16	5.8	4.0	7.2	.14	10	\$3.90
540 16	7/32	5.8	4.0	7.2	.16	10	\$4.70
540 18	1/4	5.8	4.0	7.2	.19	10	\$5.00
540 22	5/16	7.8	4.0	7.2	.29	10	\$6.20
540 24	3/8	7.8	4.7	7.5	.45	10	\$8.10



**540 90 Set 5 Pcs. MagicRing Ball End T-handle Metric Sizes** Blade chrome-vanadium-molybdenum steel, hardened, chrome-plated. Wiha T-handle high quality plastic, impact resistant.

Item No.	mm	mm	mm	mm	lbs.	Each
540 40	4.0	150	540 80	8.0	200	1.49
540 50	5.0	150	540 86	10.0	200	Each
540 60	6.0	150				\$26.70



**540 91 Set 6 Pcs. MagicRing Ball End T-handle Inch Sizes** Blade chrome-vanadium-molybdenum steel, hardened, chrome-plated. Wiha T-handle high quality plastic, impact resistant.

Item No.	Inch	Inch	Inch	Inch	lbs.	Each
540 12	5/32	150	540 18	1/4	150	1.59
540 14	3/16	150	540 22	5/16	200	Each
540 16	7/32	150	540 24	3/8	200	\$32.40



Made in Germany

Toll Free: (800) 494-6104

Wiha Soft ComfortGrip T-handle L-Keys

**Two Tools In One!**

Through the handle side torque drive

Two component soft grip handle

**Ball & Standard Hex In One Powerful Tool**

Ball Hex - Blade CVM tool steel, through hardened durability, black finish.

**Maximum Comfort & Maximum Power**

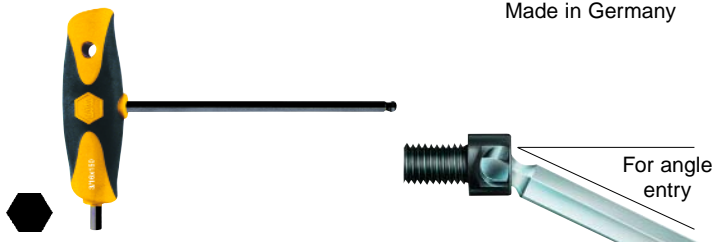
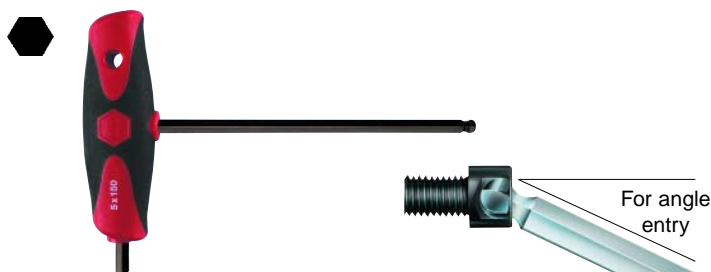

**334 ComfortGrip Ball Hex T-handle L-Key** CVM steel, hardened, black finish. Ball tip for speed & easy insertion. Wiha soft grips are molded on with through the handle side torque drive.

Item No.	Hex	Inch	Inch	lbs.	pkg.	Each
334 18*	5/64	5.88	.84	10	\$3.70	
334 20*	3/32	5.88	.88	10	\$3.70	
334 22*	7/64	5.88	.96	10	\$3.70	
334 24*	1/8	5.88	1.02	10	\$3.70	
334 26*	9/64	5.88	1.11	10	\$3.70	
334 28	5/32	5.88	1.11	10	\$3.80	
334 30	3/16	5.88	2.01	10	\$4.40	
334 32	7/32	5.88	2.28	10	\$5.00	
334 33	1/4	5.88	2.57	10	\$5.70	
334 39	5/16	7.84	4.07	10	\$7.20	
334 40	3/8	7.84	5.67	10	\$10.00	

\*No Ball - Standard Hex

**334 ComfortGrip Ball End Hex T-handle L-key** CVM steel, hardened, black finish. Ball tip for speed & easy insertion. Wiha soft grip are molded on and include through the handle side torque drive.

Item No.	Hex	mm	mm	lbs.	pkg.	Each
334 42*	2.0	150	.85	10	\$3.70	
334 44*	2.5	150	.92	10	\$3.70	
334 46*	3.0	150	.99	10	\$3.70	
334 48	4.0	150	1.21	10	\$4.50	
334 50	5.0	150	2.08	10	\$5.40	
334 52	6.0	150	2.44	10	\$5.80	
334 54	8.0	200	3.80	10	\$8.30	
334 58	10.0	200	6.06	10	\$11.10	

\*No Ball - Standard Hex



**334 96 Set 8 Pcs. Ball End Hex Metric ComfortGrip T-handle**

Blade chrome-vanadium-molybdenum steel, hardened, black oxide. Wiha T-handle high quality plastic, impact resistant.

Item No.	Hex	mm	mm	mm	lbs.
334 96	334 42*	2.0	150	334 50	5.0
	334 44*	2.5	150	334 52	6.0
	334 46*	3.0	150	334 54	8.0
	334 48	4.0	150	334 58	10.0
					2.04
					Each
					\$46.20

\*No Ball - Standard Hex



**334 94 Set 11 Pcs. Ball Hex Inch ComfortGrip T-handle L-Key**

Blade chrome-vanadium-molybdenum steel, hardened, black finish. Soft grips are molded on with through the handle side torque drive.

Item No.	Hex	Inch	Inch	Inch	Inch	lbs.
334 94	334 18*	5/64	5.88	334 30	3/16	5.88
	334 20*	3/32	5.88	334 32	7/32	5.88
	334 22*	7/64	5.88	334 33	1/4	5.88
	334 24*	1/8	5.88	334 39	5/16	7.84
	334 26*	9/64	5.88	334 40	3/8	7.84
	334 28	5/32	5.88			
						Each
						\$54.78

\*No Ball - Standard Hex

**334 98 Set 8 Pcs. Ball Hex Inch ComfortGrip T-handle**

Blade chrome-vanadium-molybdenum steel, hardened, black finish. Soft grips are molded on with through the handle side torque drive.

Item No.	Hex	Inch	Inch	Inch	Inch	lbs.
334 98	334 24*	1/8	5.88	334 32	7/32	5.88
	334 26*	9/64	5.88	334 33	1/4	5.88
	334 28	5/32	5.88	334 39	5/16	7.84
	334 30	3/16	5.88	334 40	3/8	7.84
						Each
						\$43.60

\*No Ball - Standard Hex



Made in Germany

www.wihatools.com

Wiha T-handle Hex Tools

Ergonomic handle design for high torque

Hole for hanging



Handle is molded directly onto blade

Smooth edges prevent injuries & eliminate pressure marks

Blade CVM tool steel, hardened, nickel-plated

**334 Hex Driver, With Wiha T-handle** Blade CVM steel, hardened, nickel-plated. Chamfered tip for easy insertion. Wiha-T-handle high quality plastic, impact resistant.

Item No.	Inch	Inch	Inch	Inch	lbs.	pkg.	Each
334 53	3/32	6.0	2.8	7.0	.05	10	\$2.90
334 56	7/64	6.0	2.8	7.0	.05	10	\$2.90
334 59	1/8	6.0	2.8	7.0	.06	10	\$2.90
334 62	9/64	6.0	2.8	7.0	.07	10	\$2.90
334 65	5/32	6.0	2.8	7.0	.08	10	\$3.00
334 68	3/16	6.0	3.5	7.0	.13	10	\$3.40
334 71	7/32	6.0	3.5	7.0	.16	10	\$3.90
334 74	1/4	6.0	3.5	7.0	.18	10	\$4.40
334 77	5/16	6.0	3.5	7.0	.25	10	\$5.50
334 80	3/8	6.0	4.1	7.0	.39	10	\$7.70

Item No.	mm	mm	mm	mm	Inch	lbs.	pkg.	Each
334 01	2.0	100	80	126	4.9	.05	10	\$2.90
334 06	2.0	200	80	226	8.9	.05	10	\$4.00
334 02	2.5	100	80	126	4.9	.05	10	\$2.90
334 37	2.5	200	80	226	8.9	.08	10	\$4.10
334 03	3.0	100	80	126	4.9	.05	10	\$2.90
334 04	3.0	150	80	176	6.9	.08	10	\$3.40
334 05	3.0	200	80	226	8.7	.09	10	\$3.70
334 35	3.0	350	100	382	15.0	.22	10	\$6.90
334 06	4.0	100	80	126	4.9	.07	10	\$3.00
334 07	4.0	150	80	176	6.9	.10	10	\$3.50
334 08	4.0	200	80	226	8.7	.09	10	\$3.80
334 38	4.0	350	100	382	15.0	.26	10	\$7.60
334 09	5.0	100	100	132	5.2	.13	10	\$3.70
334 10	5.0	150	100	182	7.1	.17	10	\$4.20
334 11	5.0	200	100	232	9.1	.16	10	\$4.10
334 12	5.0	350	100	382	15.0	.26	10	\$7.60
334 13	5.0	450	120	488	19.1	.53	10	\$13.40
334 14	6.0	100	100	132	5.2	.14	10	\$4.40
334 16	6.0	200	100	232	9.1	.20	10	\$4.50
334 17	6.0	350	100	382	15.0	.32	10	\$10.60
334 21	8.0	100	100	132	5.2	.20	10	\$6.00
334 23	8.0	200	100	232	9.1	.29	10	\$6.40
334 34	8.0	350	100	372	14.6	.48	10	\$10.60
334 25	10.0	100	120	138	5.4	.34	10	\$7.90
334 27	10.0	200	120	238	9.3	.49	10	\$8.50

Yellow = Inch  
Red = Metric



**334 93 Set 8 Pc. Hex Driver T-handle Metric Sizes**

Blade chrome-vanadium-molybdenum steel, hardened, nickel-plated. Wiha T-handle high quality plastic, impact resistant.

Item No.	mm	mm	mm	mm	mm	lbs.	
334 93	334 01	2.0	100	334 09	5.0	100	1.64
	334 02	2.5	100	334 16	6.0	200	
	334 03	3.0	100	334 23	8.0	200	Each
	334 06	4.0	100	334 27	10.0	200	\$34.68



**334 92 Set 10 Pc. Hex Driver T-handle Inch Sizes**

Blade chrome-vanadium-molybdenum steel, hardened, nickel-plated. Wiha T-handle high quality plastic, impact resistant.

Item No.	Inch	Inch	Inch	Inch	lbs.		
334 92	334 53	3/32	6.0	334 68	3/16	6.0	1.74
	334 56	7/64	6.0	334 71	7/32	6.0	
	334 59	1/8	6.0	334 74	1/4	6.0	
	334 62	9/64	6.0	334 77	5/16	6.0	Each
	334 65	5/32	6.0	334 80	3/8	6.0	\$39.28

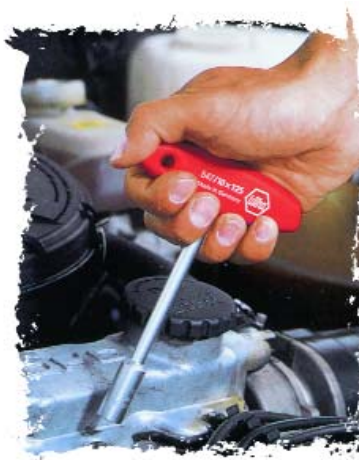



Made in Germany

Toll Free: (800) 494-6104

Wiha MagicRing SoftFinish® Hex Drivers

Screw Holding Hex Tools



Screw Holding

367 91 13 Pc. Set MagicRing Inch Ball End Screwdrivers

Hex blade chrome-vanadium-molybdenum steel, hardened, chrome-plated. Wiha-SoftFinish® handle, multi-component, cushion grip.

Item No.	Hex	Inch	Inch	Hex	Inch	Inch	lbs.
367 91	367 10*	.050	3.0	367 32	5/32	5.0	2.58
	367 13*	1/16	3.0	367 34	3/16	6.0	
	367 16*	5/64	4.0	367 36	7/32	6.0	
	367 19*	3/32	4.0	367 38	1/4	6.0	
	367 23*	7/64	4.0	367 42	5/16	8.0	
	367 26	1/8	4.0	367 44	3/8	8.0	Each
	367 28	9/64	4.0				\$56.40

\* Standard Ball - No Ring

367 MagicRing Ball End Hex-Driver Metric, With Wiha-SoftFinish®

Handle Hex blade, high alloy CVM steel, hardened, chrome-plated. Wiha-SoftFinish® handle, multi-component, cushion grip.

Item No.	Hex	mm	mm	mm	lbs.	pkg.	Each
367 15*	1.5	75	179	.06	10		\$3.30
367 20*	2.0	100	204	.07	10		\$3.30
367 25*	2.5	100	204	.07	10		\$3.30
<b>With MagicRing</b>							
367 30	3.0	100	204	.07	10		\$4.10
367 40	4.0	125	211	.12	10		\$4.30
367 50	5.0	150	243	.16	10		\$4.40
367 60	6.0	150	243	.23	10		\$5.00
367 80	8.0	200	268	.37	10		\$6.20
367 86	10.0	200	271	.54	10		\$8.00

\* Standard Ball - No Ring

367 MagicRing Ball End Hex-Driver Inch, With Wiha-SoftFinish®

Handle Hex blade, high alloy CVM steel, hardened, chrome-plated. Wiha-SoftFinish® handle, multi-component, cushion grip.

Item No.	Hex	mm	mm	mm	lbs.	pkg.	Each
367 10*	.050	80	179	.06	10		\$3.30
367 13*	1/16	80	204	.06	10		\$3.20
367 16*	5/64	100	204	.07	10		\$3.10
367 19*	3/32	100	204	.07	10		\$3.10
367 23*	7/64	100	211	.07	10		\$3.20
<b>With MagicRing</b>							
367 26	1/8	100	243	.12	10		\$4.10
367 28	9/64	100	243	.12	10		\$4.20
367 32	5/32	125	271	.12	10		\$4.20
367 34	3/16	150	271	.16	10		\$4.30
367 36	7/32	150	271	.23	10		\$4.70
367 38	1/4	150	271	.25	10		\$5.20
367 42	5/16	200	271	.37	10		\$6.20
367 44	3/8	200	271	.54	10		\$8.00

\* Standard Ball - No Ring



Screw Holding

367 93 8 Pc. Set MagicRing Inch Ball End Screwdrivers

Hex blade chrome-vanadium-molybdenum steel, hardened, chrome-plated. Wiha-SoftFinish® handle, multi-component, cushion grip.

Item No.	Hex	Inch	Inch	Hex	Inch	Inch	lbs.
367 93	367 26	1/8	4.0	367 36	7/32	6.0	2.25
	367 28	9/64	4.0	367 38	1/4	6.0	
	367 32	5/32	5.0	367 42	5/16	8.0	Each
	367 34	3/16	6.0	367 44	3/8	8.0	\$41.70



Screw Holding

367 94 6 Pc. Set MagicRing Inch Ball End Screwdrivers

Hex blade chrome-vanadium-molybdenum steel, hardened, chrome-plated. Wiha-SoftFinish® handle, multi-component, cushion grip.

Item No.	Hex	Inch	Inch	Hex	Inch	Inch	lbs.
367 94	367 26	1/8	4.0	367 34	3/16	6.0	1.26
	367 28	9/64	4.0	367 36	7/32	6.0	Each
	367 32	5/32	5.0	367 38	1/4	6.0	\$27.60



Made in Germany

www.wihatools.com

**Wiha MagicRing SoftFinish® Hex Drivers**



**Screw Holding Hex Tools**

**367 90 9 Pc. Set MagicRing Metric Ball End Hex-Drivers**

Hex blade chrome-vanadium-molybdenum steel, hardened, chrome-plated. Wiha-SoftFinish® handle, multi-component, cushion grip.

Item No.	mm	mm	mm	mm	lbs.
367 90	367 15*	1.5	75	367 50	5.0 150 2.06
	367 20*	2.0	100	367 60	6.0 150
	367 25*	2.5	100	367 80	8.0 200
	367 30	3.0	100	367 86	10.0 200
	367 40	4.0	125		Each \$40.78

\* Standard Ball - No Ring



**Screw Holding Hex Tools**

**367 92 6 Pc. Set MagicRing Metric Ball End Hex-Drivers**

Hex blade chrome-vanadium-molybdenum steel, hardened, chrome-plated. Wiha-SoftFinish® handle, multi-component, cushion grip.

Item No.	mm	mm	mm	mm	lbs.
367 92	367 30	3.0	100	367 60	6.0 150 1.86
	367 40	4.0	125	367 80	8.0 200
	367 50	5.0	150	367 86	10.0 200

Each \$32.10



**Screw Holding Hex Tools**

**367 95 4 Pc. Set MagicRing Metric Ball End Hex-Drivers**

Hex blade chrome-vanadium-molybdenum steel, hardened, chrome-plated. Wiha-SoftFinish® handle, multi-component, cushion grip.

Item No.	mm	mm	mm	mm	lbs.
367 95	367 30	3.0	100	367 50	5.0 150 .84
	367 40	4.0	125	367 60	6.0 150

Each \$18.80

**Wiha MagicRing PocketStar Fold-Ups**



**Screw Holding**

**369 9 Pc. MagicRing Inch PocketStar Fold Outs**

High alloy CVM steel, hardened, molded ergonomic handle.

Item No	Each
369 97 PocketStar	.46 \$18.96

Inch: 5/64\*, 3/32\*, 7/64\*, 1/8, 9/64, 5/32, 3/16, 7/32, 1/4"

\* Standard Ball - No Ring



**Screw Holding**

**369 7 Pc. MagicRing Metric PocketStar Fold Outs**

High alloy CVM steel, hardened, molded ergonomic handle.

Item No	Each
369 96 PocketStar	.50 \$18.96

Metric: 2.0\*, 2.5\*, 3.0, 4.0, 5.0, 6.0, 8.0mm

\* Standard Ball - No Ring





Made in Germany

Toll Free: (800) 494-6104

**Wiha Ball End 3K Series Drivers & Sets**

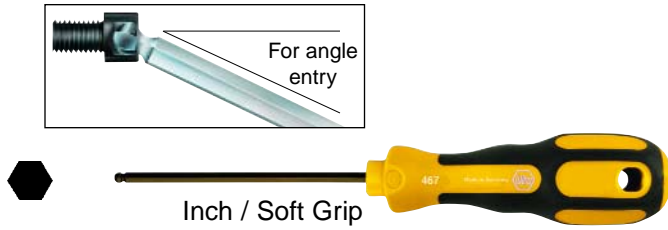

**467 Ball End Hex Inch Drivers, With 3K Ergo Soft Grip Handles**  
Blades of CVM special steel, hardened, black finish. Molded on Wiha-3K Ergo soft grip handles.

Item No.	Inch	Inch	Inch	pkg.	Each
467 02	.050	2.9	6.3	10	\$2.60
467 04	1/16	2.9	6.3	10	\$2.60
467 06	5/64	3.9	7.3	10	\$2.60
467 08	3/32	3.9	7.3	10	\$2.60
467 10	7/64	3.9	7.3	10	\$2.60
467 12	1/8	3.9	7.7	10	\$3.10
467 14	9/64	3.9	7.7	10	\$3.10
467 16	5/32	3.9	7.7	10	\$3.10
467 18	3/16	2.9	7.7	10	\$3.10
467 22	7/32	5.9	10.0	10	\$4.10
467 24	1/4	5.9	10.0	10	\$4.10
467 26	5/16	7.9	12.0	10	\$5.10
467 28	3/8	7.9	12.5	10	\$6.70

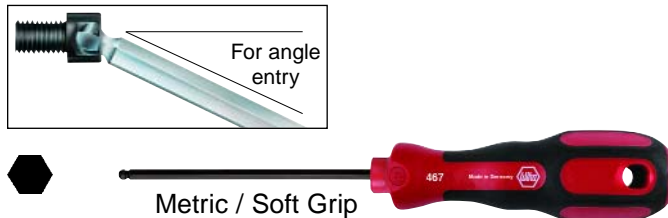

**467 Ball End Hex Metric Screwdriver, With Wiha-3K Ergo Handle**  
Blades of CVM special steel, hardened, black finish. Molded on Wiha-3K Ergo soft grip handles.

Item No.	mm	mm	mm	pkg.	Each
467 15	1.5	75	161	10	\$2.60
467 20	2.0	100	186	10	\$2.60
467 25	2.5	100	186	10	\$2.60
467 30	3.0	100	186	10	\$3.10
467 40	4.0	100	197	10	\$3.10
467 50	5.0	100	197	10	\$3.10
467 60	6.0	150	257	10	\$4.10
467 80	8.0	200	307	10	\$5.10
467 86	10.0	200	319	10	\$6.70

Yellow = Inch  
Red = Metric

**See 3K Ergonomic Series  
Screwdrivers On Pages 72-73**

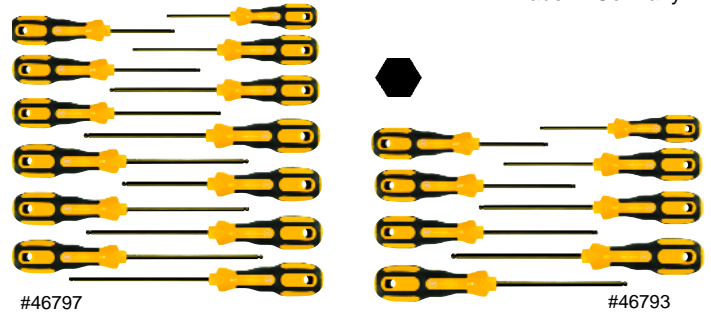

**467 97 Set 13 Pcs. Inch Ball End Hex Drivers**  
Blades of CVM special steel, hardened, black finish. Molded on Wiha-3k Ergo soft grip handles.

Item No.	Inch	mm	Size	mm	lbs.	
467 97	467 02	.050	2.9	467 16	5/32 3.9	2.49
	467 04	1/16	2.9	467 18	3/16 2.9	
	467 06	5/64	3.9	467 22	7/32 5.9	
	467 08	3/32	3.9	467 24	1/4 5.9	
	467 10	7/64	3.9	467 26	5/16 7.9	
	467 12	1/8	3.9	467 28	3/8 7.9	Each
	467 14	9/64	3.9			\$44.80

**467 93 Set 8 Pcs. Inch Ball End Hex Drivers**  
Blades of CVM special steel, hardened, black finish. Molded on Wiha-3k Ergo soft grip handles.

Item No.	Inch	mm	Size	mm	lbs.	
467 93	467 02	.050	2.9	467 10	7/64 3.9	1.19
	467 04	1/16	2.9	467 12	1/8 3.9	
	467 06	5/64	3.9	467 14	9/64 3.9	Price
	467 08	3/32	3.9	467 16	5/32 3.9	\$22.98



**467 99 Set 9 Pcs. Metric Ball End Hex Drivers**  
Blades of CVM special steel, hardened, black finish. Molded on Wiha-3k Ergo soft grip handles.

Item No.	mm	mm	Size	mm	lbs.	
467 99	467 15	1.5	75	467 50	5.0 100	2.04
	467 20	2.0	100	467 60	6.0 150	
	467 25	2.5	100	467 80	8.0 200	
	467 30	3.0	100	467 86	10.0 200	Price
	467 40	4.0	100			\$33.68

**467 96 Set 7 Pcs. Metric Ball End Hex Drivers**  
Blades of CVM special steel, hardened, black finish. Molded on Wiha-3k Ergo soft grip handles.

Item No.	mm	mm	Size	mm	lbs.	
467 96	467 15	1.5	75	467 40	4.0 100	1.15
	467 20	2.0	100	467 50	5.0 100	
	467 25	2.5	100	467 60	6.0 150	Price
	467 30	3.0	100			\$20.98



Made in Germany

www.wihatools.com

**Nickel-Plated Long Arm Hex L-keys**



• Ideal for use in clean rooms & other environments where non-oxidizing surfaces are specified or required.

Nickel-Plated

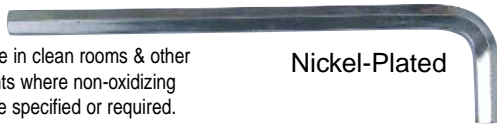

**352 Metric L-wrench Hex Key, Long Arm**, high alloy CVM steel, hardened, nickel plated. Precision machined, burr free chamfered ends.

Item	Hex	mm	Inch	mm	Inch	pkg.	Each
352 01	1.5	91	3.58	15	.58	10	\$ .32
352 02	2.0	101	3.98	18	.70	10	\$ .38
352 04	2.5	113	4.45	20	.78	10	\$ .52
352 06	3.0	128	5.04	23	.90	10	\$ .72
352 08	4.0	142	5.59	29	1.13	10	\$ .82
352 10	5.0	163	6.42	33	1.29	10	\$ .96
352 11	6.0	184	7.24	38	1.49	10	\$ 1.20
352 12	7.0	194	7.64	41	1.60	10	\$ 2.22
352 14	8.0	206	8.11	44	1.72	10	\$ 2.34
352 17	10.0	231	9.09	50	1.96	10	\$ 3.62
352 19	12.0	259	10.20	57	2.23	1	\$ 5.95
352 21	14.0	291	11.46	70	2.74	1	\$ 8.68
352 23	17.0	333	13.11	80	3.13	1	\$ 13.14
352 27	19.0	375	14.76	89	3.49	1	\$ 17.54

**352 Inch L-wrench Hex Key, Long Arm**

Item	Hex	mm	Inch	pkg.	Each
352 31	.050	73	2.87	10	\$ .32
352 33	1/16	80	3.15	10	\$ .32
352 35	5/64	88	3.46	10	\$ .38
352 37	3/32	101	3.98	10	\$ .46
352 39	7/64	111	4.37	10	\$ .92
352 41	1/8	121	4.76	10	\$ .92
352 43	9/64	136	5.35	10	\$ .76
352 51	5/32	148	5.83	10	\$ .76
352 52	3/16	163	6.42	10	\$ .96
352 53	7/32	170	6.69	10	\$ 1.16
352 54	1/4	178	7.01	10	\$ 1.26
352 55	5/16	189	7.44	10	\$ 2.10
352 56	3/8	200	7.87	10	\$ 3.06
352 57	1/2	-	-	1	\$ 6.92
352 58	9/16	-	-	1	\$ 9.16
352 59	5/8	-	-	1	\$ 10.98
352 61	3/4	-	-	1	\$ 20.76



**352 97 Metric Hex L-wrench Set,**

**9 Pc. in Plastic Holder**

Equipped with 1.5, 2.0, 2.5, 3.0, 4.0, 5.0, 6.0, 8.0, 10.0mm

pkg. 1 Each \$16.98



**352 95 Inch Hex L-wrench Set,**

**13 Pc. in Plastic Holder**

Equipped with .050, 1/16, 5/64, 3/32, 7/64, 1/8, 9/64, 5/32, 3/16, 7/32, 1/4, 5/16, 3/8"

pkg. 1 Each \$13.98

**Black Finish Long Arm Hex L-keys**



• Ideal for use in clean rooms & other environments where non-oxidizing surfaces are specified or required.

Black Finish

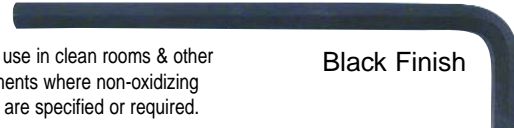

**352 Metric L-wrench Hex Key, Long Arm**, high alloy CVM steel, hardened, black finish. Precision machined, burr free chamfered ends.

Item	Hex	mm	Inch	mm	Inch	pkg.	Each
352 05	1.3	80	3.15	13	.51	10	\$ .28
352 15	1.5	91	3.58	15	.58	10	\$ .32
352 20	2.0	101	3.98	18	.70	10	\$ .40
352 25	2.5	113	4.45	20	.78	10	\$ .48
352 30	3.0	128	5.04	23	.90	10	\$ .68
352 40	4.0	142	5.59	29	1.13	10	\$ .88
352 50	5.0	163	6.42	33	1.29	10	\$ 1.02
352 60	6.0	184	7.24	38	1.49	10	\$ 1.24
352 70	7.0	194	7.64	41	1.60	10	\$ 1.76
352 80	8.0	206	8.11	44	1.72	10	\$ 2.42
352 82	10.0	231	9.09	50	1.96	10	\$ 3.10
352 84	12.0	259	10.20	57	2.23	1	\$ 5.20
352 85	14.0	291	11.46	70	2.74	1	\$ 5.48
352 86	17.0	333	13.11	80	3.13	1	\$ 12.54
352 88	19.0	375	14.76	89	3.49	1	\$ 17.36

**352 Inch L-wrench Hex Key, Long Arm**

Item	Hex	mm	Inch	pkg.	Each
352 14	.050	73	2.87	10	\$ .34
352 16	1/16	80	3.15	10	\$ .34
352 18	5/64	88	3.46	10	\$ .40
352 22	3/32	101	3.98	10	\$ .46
352 24	7/64	111	4.37	10	\$ .90
352 26	1/8	121	4.76	10	\$ .86
352 28	9/64	136	5.35	10	\$ .76
352 32	5/32	148	5.83	10	\$ .76
352 34	3/16	163	6.42	10	\$ .94
352 36	7/32	170	6.69	10	\$ 1.15
352 38	1/4	178	7.01	10	\$ 1.24
352 42	5/16	189	7.44	10	\$ 2.04
352 44	3/8	200	7.87	10	\$ 2.96
352 45	1/2	-	-	1	\$ 6.84
352 46	9/16	-	-	1	\$ 9.10
352 47	5/8	-	-	1	\$ 10.90
352 48	3/4	-	-	1	\$ 20.58
352 49	1"	-	-	1	\$ 43.86



**352 90 Metric Hex L-wrench Set,**

**9 Pc. in Plastic Holder**

Equipped with 1.5, 2.0, 2.5, 3.0, 4.0, 5.0, 6.0, 8.0, 10.0mm

pkg. 1 Each \$12.98



**352 91 Inch Hex L-wrench Set,**

**13 Pc. in Plastic Holder**

Equipped with .050, 1/16, 5/64, 3/32, 7/64, 1/8, 9/64, 5/32, 3/16, 7/32, 1/4, 5/16, 3/8"

pkg. 1 Each \$14.48



Made in Germany

Toll Free: (800) 494-6104

**Short Arm Hex L-keys Nickel Finish**

• Ideal for use in clean rooms & other environments where non-oxidizing surfaces are specified or required.



Nickel-Plated

**351 Metric L-wrench Hex Key, Short Arm**, high alloy CVM steel, hardened, nickel plated. Precision machined, burr free chamfered ends.

Item No.	Size	mm	Inch	mm	Inch	pkg.	Each
351 04	1.5	46	1.8	15	.58	10	\$ .27
351 08	2.0	51	2.0	18	.70	10	\$ .27
351 12	2.5	57	2.2	20	.78	10	\$ .30
351 16	3.0	64	2.5	23	.90	10	\$ .34
351 20	4.0	72	2.8	29	1.13	10	\$ .37
351 24	5.0	83	3.2	33	1.29	10	\$ .51
351 28	6.0	94	3.7	38	1.49	10	\$ .62
351 32	7.0	99	3.9	41	1.60	10	\$ .80
351 36	8.0	105	4.1	44	1.72	10	\$ 1.08
351 40	9.0	112	4.4	47	1.84	10	\$ 1.48
351 44	10.0	119	4.7	50	1.96	10	\$ 1.66
351 45	12.0	134	5.0	57	2.23	10	\$ 2.52
351 75	14.0	151	5.9	70	2.74	1	\$ 4.28
351 77	17.0	173	6.8	80	3.13	1	\$ 7.18
351 79	19.0	195	7.7	89	3.49	1	\$ 9.42

**351 Inch L-wrench Hex Key, Short Arm** Nickel-plated

Item No.	Size	mm	Inch	mm	Inch	pkg.	Each
351 43	.050	40	1.6	10	.39	10	\$ .27
351 46	1/16	46	1.8	16	.63	10	\$ .27
351 47	5/64	50	2.0	16	.63	10	\$ .30
351 50	3/32	52	2.1	19	.75	10	\$ .34
351 52	7/64	54	2.1	19	.75	10	\$ .37
351 53	1/8	58	2.3	21	.83	10	\$ .37
351 55	9/64	62	2.4	23	.91	10	\$ .41
351 56	5/32	68	2.7	25	.99	10	\$ .44
351 59	3/16	70	2.8	26	1.0	10	\$ .58
351 62	7/32	77	3.1	29	1.2	10	\$ .66
351 65	1/4	88	3.5	31	1.2	10	\$ .76
351 68	5/16	98	3.9	36	1.4	10	\$ 1.34
351 71	3/8	107	4.2	38	1.5	10	\$ 2.12
351 74	1/2	133	5.2	44	1.7	1	\$ 4.14
351 76	9/16	158	6.2	64	2.5	1	\$ 4.52
351 78	5/8	175	6.9	71	2.8	1	\$ 7.60
351 80	3/4	198	7.8	89	3.5	1	\$ 11.48



**351 91 Metric Hex L-wrench Set, 9 Pc. in Plastic Holder**

Equipped with 1.5, 2.0, 2.5, 3.0, 4.0, 5.0, 6.0, 8.0, 10.0mm  
 lbs. .59 pkg. 1 Each \$7.98



**351 92 Inch Hex L-wrench Set, 8 Pc. in Plastic Holder**

Equipped with 5/64, 3/32, 1/8, 5/32, 3/16, 7/32, 1/4, 5/16"  
 lbs. .41 pkg. 1 Each \$6.78



**351 93 Metric Hex L-wrench Set, 6 Pc. in Plastic Holder**

Equipped with 1.5, 2.0, 2.5, 3.0, 4.0, 5.0mm  
 lbs. .20 pkg. 1 Each \$4.98



**351 94 Inch Hex L-wrench Set, 13 Pc. in Plastic Holder**

Equipped with .050 - 3/8"  
 lbs. .68 pkg. 1 Each \$11.48

**Short Arm Hex L-keys Black Finish**

• Ideal for use in clean rooms & other environments where non-oxidizing surfaces are specified or required.

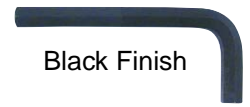

Black Finish

**353 Metric L-wrench Hex Key, Short Arm**, high alloy CVM steel, hardened, black finish. Precision machined, burr free chamfered ends.

Item No.	Size	mm	Inch	mm	Inch	pkg.	Each
353 01	0.7	31.5	1.24	-	-	10	\$ .50
353 02	0.9	32	1.26	-	-	10	\$ .50
353 03	1.3	41	1.61	13	.50	10	\$ .22
353 04	1.5	46	1.81	15	.58	10	\$ .22
353 05	2.0	51	2.01	18	.70	10	\$ .22
353 06	2.5	57	2.21	20	.78	10	\$ .24
353 07	3.0	64	2.52	23	.90	10	\$ .32
353 08	4.0	72	2.83	29	1.13	10	\$ .38
353 09	5.0	83	3.27	33	1.29	10	\$ .52
353 10	6.0	94	3.70	38	1.49	10	\$ .62
353 11	7.0	99	3.90	41	1.60	10	\$ .82
353 12	8.0	105	4.13	44	1.72	10	\$ 1.10
353 13	9.0	112	4.41	47	1.84	10	\$ 1.50
353 14	10.0	119	4.69	50	1.96	10	\$ 1.78
353 16	11.0	126	4.96	53	2.07	10	\$ 2.10
353 17	12.0	134	5.28	57	2.23	1	\$ 3.40
353 18	14.0	151	5.94	70	2.74	1	\$ 5.08
353 19	17.0	173	6.81	80	3.13	1	\$ 7.38
353 20	19.0	195	7.68	89	3.49	1	\$ 11.12
353 21	22.0	217	8.89	102	4.00	1	\$ 27.52

**353 Inch L-wrench Hex Key, Short Arm** black finish

Item No.	Size	mm	Inch	mm	Inch	pkg.	Each
353 30	.050	41	1.61	10	.39	10	\$ .26
353 31	1/16	47	1.85	16	.63	10	\$ .26
353 32	5/64	51	2.01	16	.63	10	\$ .30
353 33	3/32	55	2.17	19	.75	10	\$ .34
353 34	7/64	58	2.28	19	.75	10	\$ .34
353 35	1/8	61	2.40	21	.83	10	\$ .42
353 36	9/64	65	2.56	23	.91	10	\$ .42
353 37	5/32	72	2.83	25	.99	10	\$ .46
353 38	3/16	76	2.99	26	1.0	10	\$ .58
353 39	7/32	84	3.31	29	1.2	10	\$ .74
353 40	1/4	94	3.70	31	1.2	10	\$ .78
353 41	5/16	106	4.17	36	1.4	10	\$ 1.36
353 42	3/8	117	4.61	38	1.5	10	\$ 2.16
353 43	1/2	143	5.63	44	1.7	1	\$ 4.50
353 45	9/16	158	6.22	64	2.5	1	\$ 4.98
353 46	5/8	176	6.93	71	2.8	1	\$ 7.26
353 47	3/4	198	7.80	89	3.5	1	\$ 11.80
353 48	1"	220	8.66	-	-	1	\$ 29.70



**353 90 Metric Hex L-wrench Set, 9 Pc. in Plastic Holder**

Equipped with 1.5, 2.0, 2.5, 3.0, 4.0, 5.0, 6.0, 8.0, 10.0mm  
 lbs. .59 pkg. 1 Each \$8.98



**353 91 Inch Hex L-wrench Set, 13 Pc. in Plastic Holder**



Equipped with .050 - 3/8"  
 lbs. .41 pkg. 1 Each \$10.98





Made in Germany

www.wihatools.com

Wiha Maxiflex Hose System Index

	Description	Page
	Maxiflex Hose System 1/4"	45
	Maxiflex Hose System 1/2"	46

Wiha Hammers Index

	Description	Page
	Dead Blow Hammers	47
	Sledge Hammers	47



Wiha Maxiflex Hose System



Flexible hose system for fluids & air

Resistant to chemicals and solvents, non-conductive

Will not alter under pressure or machine vibrations

**NEW**  
from Wiha

A practical holder allows you to set the hose for many diverse applications in fixed constructions.

Available in 1/4" & 1/2" Diameters

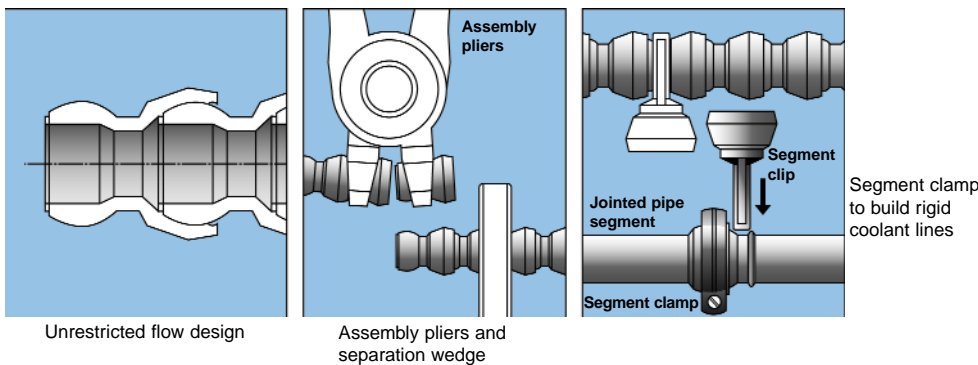

Product Features:

- Flexible hose system for cooling and cleaning in sawing, drilling, turning, milling, grinding and EDM applications 1/4" or 1/2"
- Dimensionally stable through tight fitting components. Will not alter under pressure or machine vibrations
- Resistant to chemicals and solvents, non-conductive
- Compatible with competitive systems
- Ideally suited for positioning and distributing fluids & air

Maxiflex is a universal articulated hose system with the greatest flexibility. The broad range of hose joints, nozzles, threaded connectors, Y-junctions and in line valves allow for a perfect solution to every cooling or cleaning problem. A high quality and indestructible plastic, extensive design knowledge and precise manufacturing of all components ensures that this flexible hose system functions for each individual application without deforming. Adapters enable the user to expand the maxiflex and incorporate other flexible hose systems.

Besides transporting and distributing cooling and cleaning agents the Maxiflex offers more possibilities: use in air vacuum or blowing systems as well as the distribution of various solvents. A practical holder allows you to set the hose for many diverse applications in fixed constructions.



Made in Germany

Toll Free: (800) 494-6104

**Wiha Maxiflex Hose System 1/4"**

**344 90 Maxiflex Starter Kit**  
 2 Threaded Connectors R 1/4" & R 1/8"  
 3 Cylindrical Nozzles 1/16", 1/8", 7/32"  
 22 Segments - 11"

Item No.	OAL	pkg.	Each
344 90	320mm/12.6"	1	\$8.95



**344 02 Segments**  
 1/4" - Pack with 22 segments 11"

Item No.	OAL	pkg.	Each
344 02	280mm/11.0"	1	\$4.84



**344 04 1/16" Nozzle**  
 1/4" - Nozzle Ø 1.6mm - 1/16"

Item No.	Dia.	pkg.	Each
344 04	1.6mm/.620"	1	\$1.12



**344 06 1/8" Nozzle**  
 1/4" - Nozzle Ø 3.2mm - 1/8"

Item No.	Dia.	pkg.	Each
344 06	3.2mm/.125"	1	\$1.12



**344 08 7/32" Nozzle**  
 1/4" - Nozzle Ø 5.6mm - 7/32"

Item No.	Dia.	pkg.	Each
344 08	5.6mm/.22"	1	\$1.12



**344 10 Straight Flat Nozzle**  
 1/4" - Flat Nozzle 24mm wide

Item No.	Width	pkg.	Each
344 10	24mm/.94"	1	\$3.98



**344 12 Straight Multi Hole Nozzle**  
 1/4" - Multi Hole Nozzle 24mm wide  
 7 Holes  
 .060 Hole Diameter

Item No.	Width	pkg.	Each
344 12	24mm/.94"	1	\$3.98



**344 14 1/16" Nozzle 90° Bend**  
 1/4" - Angular Nozzle Ø 1.6mm - 1/16"

Item No.	Dia.	pkg.	Each
344 14	1.6mm/.620"	1	\$1.40



**344 16 1/8" Nozzle 90° Bend**  
 1/4" - Angular Nozzle Ø 3.2mm - 1/8"

Item No.	Dia.	pkg.	Each
344 16	3.2mm/.125"	1	\$1.40



**344 18 7/32" Nozzle 90° Bend**  
 1/4" - Angular Nozzle Ø 5.6mm - 7/32"

Item No.	Dia.	pkg.	Each
344 18	5.6mm/.22"	1	\$1.40



**344 20 Multi Hole Spray Bar**  
 1/4" - Right Angle Multi Hole Nozzle  
 7 Holes  
 .078 Hole Diameter

Item No.	Width	pkg.	Each
344 20	24mm/.94"	1	\$3.20

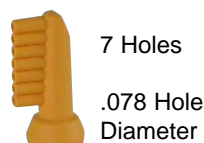

**344 32 Adapter for LcLn - 1/4"**

Item No.	OAL	pkg.	Each
344 32	7x2mm	1	\$2.90



**344 34 Male Double End Segment**

Item No.	Size	pkg.	Each
344 34	1/4"	1	\$3.20



**344 36 Female Double End Segment**

Item No.	Size	pkg.	Each
344 36	1/4"	1	\$3.20



**344 22 BSPT Threaded Connector R 1/8"**

Item No.	Size	pkg.	Each
344 22	1/8"	1	\$1.12



**344 24 BSPT Threaded Connector R 1/4"**

Item No.	Size	pkg.	Each
344 24	1/4"	1	\$1.12



**344 26 NPT Threaded Connector R 1/8"**

Item No.	Size	pkg.	Each
344 26	1/8"	1	\$1.12



**344 28 NPT Threaded Connector R 1/4"**

Item No.	Size	pkg.	Each
344 28	1/4"	1	\$1.12



**344 30 1/4" Y-Junction**

Item No.	Size	pkg.	Each
344 30	1/4"	1	\$3.20



**344 38 In Line Valve**

Item No.	Size	pkg.	Each
344 38	1/4"	1	\$6.40



**344 40 Segment Clip**

Item No.	Size	pkg.	Each
344 40	1/4"	1	\$3.20



**344 42 Separation Wedge**

Item No.	Size	pkg.	Each
344 42	1/4"	1	\$3.98



**344 44 Assembly Pliers**

Item No.	Size	pkg.	Each
344 44	1/4"	1	\$14.98





Made in Germany

www.wihatools.com

**Wiha Maxiflex Hose System 1/2"**

**340 90 Maxiflex Starter Kit**  
2 Threaded Connectors R 1/2" & 3/8" NPT  
Straight, 90° Bend & Multi Hole Nozzles  
12 Segments - 12.6"

Item No.	OAL	pkg.	Each
340 90	320mm/12.6"	1	\$13.98



**340 00 Segments**  
1/2" - Pack with 12 segments 11"

Item No.	OAL	pkg.	Each
340 00	279mm/11"	1	\$5.28



**340 46 1/2" Pipe Segment**

Item No.	OAL	pkg.	Each
340 46	4.25"	1	\$3.60



**340 48 1/2" Segment Clamp**  
Including Screws

Item No.	pkg.	Each
340 48	1	\$2.98



**340 02 1/2" Straight Nozzle**  
1/2" - Nozzles Ø 10mm

Item No.	Dia.	pkg.	Each
340 02	10mm/.393"	1	\$1.20



**340 08 Straight Multi Hole Nozzle**  
1/2" - Multi Hole Nozzle 30mm wide

Item No.	Width	pkg.	Each
340 08	30mm/1.2"	1	\$5.40



**340 04 Straight Flat Nozzle**  
1/2" - Flat Nozzle 30mm wide

Item No.	Width	pkg.	Each
340 04	30mm/1.2"	1	\$5.20



**340 06 Straight Flat Nozzle**  
1/2" - Flat Nozzle 60mm wide

Item No.	Width	pkg.	Each
340 06	60mm/2.4"	1	\$5.60



**340 12 Nozzle 90° Bend**  
1/2" - Angular Nozzle Ø 7mm

Item No.	Dia.	pkg.	Each
340 12	7mm/.275"	1	\$1.98



**340 10 Nozzle 90° Bend**  
1/2" - Angular Nozzle Ø 10mm

Item No.	Dia.	pkg.	Each
340 10	10mm/.393"	1	\$1.98



**340 14 Multi Hole Angular Nozzle**  
1/2" - Right Angle Side Spray Nozzle

Item No.	Width	pkg.	Each
340 14	45mm/1.7"	1	\$3.98



**340 28 Reducer Adapter 1/2" to 1/4"**

Item No.	Size	pkg.	Each
340 28	1/2"	1	\$2.98



**340 30 Adapter - 1/2" LcLn**

Item No.	Size	pkg.	Each
340 30	1/2"	1	\$2.90



**340 34 Female Double End Segment**

Item No.	Size	pkg.	Each
340 34	1/2"	1	\$3.98



**340 36 Male Double End Segment**

Item No.	Size	pkg.	Each
340 36	1/2"	1	\$3.98



**340 16 BSPT Threaded Connector**  
R 3/8"

Item No.	Size	pkg.	Each
340 16	1/8"	1	\$1.20



**340 18 BSPT Threaded Connector**  
R 1/2"

Item No.	Size	pkg.	Each
340 18	1/4"	1	\$1.20



**340 20 NPT Threaded Connector**  
R 3/8"

Item No.	Size	pkg.	Each
340 20	1/8"	1	\$1.20



**340 22 NPT Threaded Connector**  
R 1/2"

Item No.	Size	pkg.	Each
340 22	1/4"	1	\$1.20



**340 24 Y-Junction**

Item No.	Size	pkg.	Each
340 24	1/2"	1	\$4.40



**340 26 Y Reducer Junction 1/2"-1/4"**

Item No.	Size	pkg.	Each
340 26	1/2"	1	\$4.40



**340 38 In Line Valve**

Item No.	Size	pkg.	Each
340 38	1/2"	1	\$9.20



**340 40 Segment Clip**

Item No.	Size	pkg.	Each
340 40	1/2"	1	\$3.98



**340 42 Separation Wedge**

Item No.	Size	pkg.	Each
340 42	1/2"	1	\$5.98



**340 44 Assembly Pliers**

Item No.	Size	pkg.	Each
340 44	1/2"	1	\$14.98





Made in Germany

Toll Free: (800) 494-6104

**Dead Blow and Sledge Hammers**



**802 Dead Blow, Medium Hard Face Hammer, Recoilless, Polyurethane, Steel Tube Shaft. "GS" Sign, Cushion Grip.**

- Preserves sensitive surfaces and edges.
- Increases striking power.
- Avoids hand fatigue.

**Application:**

- Machine tools and gear box construction.
- Sheet metal shops and repair shops.

Faces polyurethane, shatterproof, wear resistant, extremely durable.

Faces replaceable. Tubular handle, lacquered in blue, cushion grip.

Item No.	mm	Inch	mm	Inch	mm	Inch	oz.	pkg.	Each
802 25	25	1.0	106	4.2	288	11.3	18	1	\$25.98
802 30	30	1.2	115	4.5	290	11.4	19	1	\$25.98
802 35	35	1.4	118	4.6	300	11.8	22	1	\$26.98
802 40	40	1.6	125	4.9	305	12.0	26	1	\$30.98
802 45	45	1.8	130	5.1	310	12.2	30	1	\$34.98
802 50	50	2.0	130	5.1	365	14.4	40	1	\$38.98
802 60	60	2.3	156	6.1	375	14.7	72	1	\$52.98
802 70	70	2.8	161	6.3	385	15.1	97	1	\$63.98



**802 Replacement Hammer Faces - Medium hard.**

Item No.	mm	Inch	lbs.	pkg.	Each
802 00	25	1.0	.04	1	\$3.90
802 02	30	1.2	.04	1	\$4.00
802 04	35	1.4	.05	1	\$4.70
802 06	40	1.6	.08	1	\$5.30
802 08	45	1.8	.12	1	\$6.30
802 10	50	2.0	.16	1	\$7.20
802 13	60	2.3	.29	1	\$10.10
802 16	70	2.8	.39	1	\$11.10



**802 90 3 Piece Dead Blow Hammer Set - Medium hard.**

Item No.	mm	Inch	lbs.	Each
802 90	802 30	30	6.35	
	802 40	40	Each	
	802 50	50	\$95.00	



**800 Dead Blow, Medium Hard Face, Recoilless, Polyurethane Face, Hickory Handle. Application:**

- Tools, engineering gear box construction.
- Sheet metal and repair shops, heavy industry.

Steel head for incredible strength. Faces polyurethane, shatterproof, wear resistant, extremely durable. Faces replaceable. Hickory handle.

Item No.	mm	Inch	mm	Inch	mm	Inch	oz.	pkg.	Each
800 25	25	1.0	106	4.2	320	12.5	18.3	1	\$22.98
800 30	30	1.2	113	4.4	350	13.7	20.9	1	\$22.98
800 35	35	1.4	115	4.5	355	13.9	24.9	1	\$23.98
800 40	40	1.6	123	4.8	375	14.7	29.9	1	\$27.98
800 45	45	1.8	130	5.1	380	14.9	37.3	1	\$31.98
800 50	50	2.0	134	5.3	385	15.1	49.4	1	\$35.98
800 60	60	2.3	158	6.2	420	16.5	72.0	1	\$49.98
800 70	70	2.8	158	6.2	430	16.9	97.0	1	\$60.98



**802 Replacement Hammer Faces - Medium hard.**

Item No.	mm	Inch	lbs.	pkg.	Each
802 00	25	1.0	.04	1	\$3.90
802 02	30	1.2	.04	1	\$4.00
802 04	35	1.4	.05	1	\$4.70
802 06	40	1.6	.08	1	\$5.30
802 08	45	1.8	.12	1	\$6.30
802 10	50	2.0	.16	1	\$7.20
802 13	60	2.3	.29	1	\$10.10
802 16	70	2.8	.39	1	\$11.10



**802 Dead Blow Sledge, Medium Hard Face, Recoilless, Polyurethane Face, Hickory Handle. Application:**

- Tools, engineering gear box construction.
- Sheet metal and repair shops, heavy industry.

Faces polyurethane, shatterproof, wear resistant, extremely durable.

Faces replaceable. Hickory handle.

Item No.	mm	Inch	mm	Inch	mm	Inch	lbs.	pkg.	Each
802 80	80	3.1	205	8.0	882	34.6	10.0	1	\$149.98
802 99	100	3.9	210	8.2	1002	39.3	15.1	1	\$221.98

**802 Replacement Hammer Tips - Medium hard.**

Item No.	mm	Inch	lbs.	pkg.	Each
802 19	80	3.1	.06	1	\$12.98
802 22	100	3.9	.10	1	\$18.98









Made in Germany

Toll Free: (800) 494-6104

Wiha SoftFinish® Handle - Ergonomic Cushion Grip

Wiha SoftFinish® Handle: Featuring advanced technology dual material molding. A remarkable improvement in handle design, comfort and performance. The SoftFinish® ergonomic shape allows maximum torque and user comfort.

Wiha exclusive "SoftFinish® Zone" features solid molded core with soft outer cushion grip. Requires less force, yet achieves 40% more torque than conventional handles.

Wiha tips are precision machined to exact tolerances for a perfect fit every time.

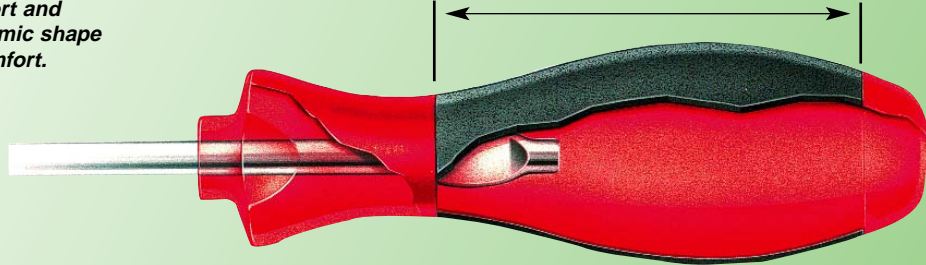

All blades are made of Wiha's exclusive formula chrome-vanadium-molybdenum tool steel, super hardened plated for unmatched durability.

Handle is molded directly onto the blade for a permanent bond. Large optimized handle diameter allows higher torque with less user hand fatigue.



**341 Nut Driver, With Wiha-SoftFinish® Handle.** Inch sizes. Blade CVM steel, hardened. Deep drawn 1" socket. Solid shafts. Wiha-SoftFinish® handle, multi-component, cushion grips.

Item	⊙	—	—	—	—	—	—	—
No.	Inch	Inch	mm	mm	Inch	lbs.	pkg.	Each
341 34	9/64	5.0	125	231	9.1	.18	10	\$5.90
341 35	5/32	5.0	125	238	9.4	.24	10	\$5.90
341 36	3/16	5.0	125	238	9.4	.25	10	\$5.90
341 37	7/32	5.0	125	238	9.4	.26	10	\$5.90
341 38	1/4	5.0	125	246	9.7	.38	10	\$5.90
341 39	5/16	5.0	125	246	9.7	.40	10	\$5.90
341 40	11/32	5.0	125	246	9.7	.40	10	\$6.00
341 41	3/8	5.0	125	246	9.7	.40	10	\$6.10
341 42	7/16	5.0	125	246	9.7	.40	10	\$7.00
341 43	1/2	5.0	125	246	9.7	.40	10	\$7.50
341 44	9/16	5.0	125	246	9.7	.40	10	\$8.90
341 45	5/8	5.0	125	246	9.7	.40	10	\$9.90



**341 93 Set 7 Pcs. Nut Driver Inch Sizes**

Blade chrome-vanadium-molybdenum steel, hardened. Deep drawn 1" socket. Wiha-SoftFinish® handle, multi-component.

Item	⊙	—	—	⊙	—	—	—
No.	Inch	mm	mm	Inch	mm	lbs.	
341 93	341 36	3/16	125	341 41	3/8	125	1.89
	341 38	1/4	125	341 42	7/16	125	
	341 39	5/16	125	341 43	1/2	125	Each
	341 40	11/32	125				\$43.80



**341 Nut Driver, With Wiha-SoftFinish® Handle**  
Blade CVM steel, hardened. Deep drawn 1" socket. Solid shafts. Wiha-SoftFinish® handle, multi-component, cushion grips.

Item	⊙	—	—	—	—	—	—	—
No.	mm	mm	Inch	mm	Inch	lbs.	pkg.	Each
341 20	5.0	125	5.0	215	8.5	.14	10	\$5.90
341 21	5.5	125	5.0	215	8.5	.14	10	\$5.90
341 22	6.0	125	5.0	215	8.5	.15	10	\$5.90
341 23	7.0	125	5.0	238	9.4	.25	10	\$5.90
341 24	8.0	125	5.0	238	9.4	.25	10	\$5.90
341 25	9.0	125	5.0	238	9.4	.26	10	\$6.00
341 26	10.0	125	5.0	238	9.4	.27	10	\$6.10
341 27	11.0	125	5.0	247	9.7	.37	10	\$7.00
341 28	12.0	125	5.0	247	9.7	.40	10	\$7.30
341 29	13.0	125	5.0	247	9.7	.40	10	\$7.50
341 30	14.0	125	5.0	247	9.7	.40	10	\$8.90
341 31	15.0	125	5.0	247	9.7	.40	10	\$9.50



**341 94 Set 7 Pcs. Nut Driver Metric Sizes**

Item	⊙	—	—	⊙	—	—	—
No.	mm	mm	mm	mm	mm	lbs.	
341 94	341 20	5.0	125	341 24	8.0	125	1.89
	341 21	5.5	125	341 26	10.0	125	
	341 22	6.0	125	341 29	13.0	125	Each
	341 23	7.0	125				\$42.80



Made in Germany

www.wihatools.com

**Wiha SoftFinish® Heavy Duty Nut Drivers**



**347 Nut Driver With Hex Bolster & Wiha-SoftFinish® Handle**

Blade CVM steel, hardened. Deep drawn 1" socket. Hex bolster for additional torque, Solid shafts. Wiha-SoftFinish® cushion grip handle.

Item No.	mm	mm	mm	mm	Inch	lbs.	pkg.	Each
347 12	7.0	125	10.0	238	9.4	.25	10	\$8.90
347 15	8.0	125	10.0	238	9.4	.25	10	\$9.40
347 18	9.0	125	10.0	238	9.4	.26	10	\$10.20
347 21	10.0	125	10.0	238	9.4	.27	10	\$10.60
347 24	11.0	125	13.0	247	9.7	.37	10	\$12.00
347 27	12.0	125	13.0	247	9.7	.40	10	\$13.00
347 30	13.0	125	13.0	247	9.7	.40	10	\$13.50
347 33	14.0	125	13.0	247	9.7	.40	10	\$17.70



**347 Nut Driver, With Wiha-SoftFinish® Handle. Inch sizes.**

Item No.	Inch	Inch	mm	Inch	mm	Inch	lbs.	pkg.	Each
347 53	3/16	5.0	125	5/16	231	9.1	.18	10	\$7.90
347 59	1/4	5.0	125	3/8	238	9.4	.24	10	\$7.90
347 65	5/16	5.0	125	3/8	238	9.4	.25	10	\$9.70
347 71	3/8	5.0	125	3/8	238	9.4	.26	10	\$10.80
347 74	7/16	5.0	125	1/2	246	9.7	.38	10	\$12.70
347 77	1/2	5.0	125	1/2	246	9.7	.40	10	\$13.80

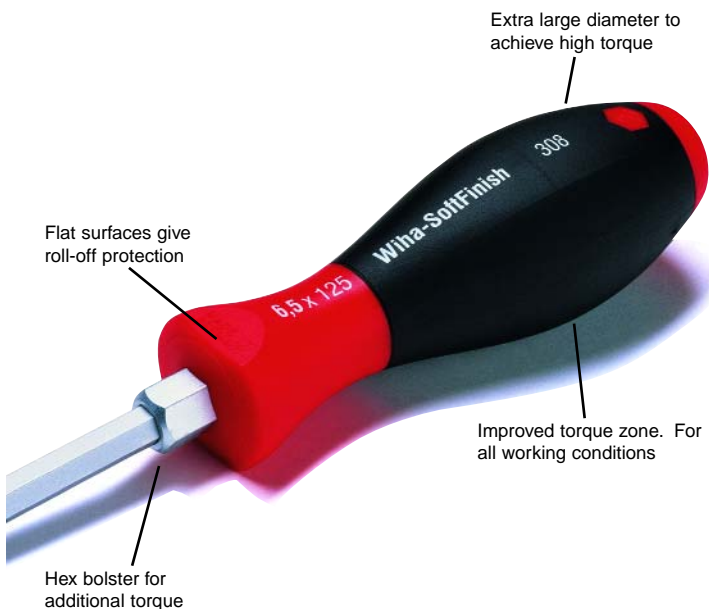

**347 91 Set 5 Pcs. Nut Driver Metric Sizes**

Blade chrome-vanadium-molybdenum steel, hardened. Deep drawn 1" socket. Hex bolster for additional torque.

Wiha-SoftFinish® handle, multi-component, cushion grips.

Item No.	mm	mm	mm	mm	lbs.
347 91	*341 20	5.0	125	347 21	10.0
	*341 22	6.0	125	347 24	11.0
	347 15	8.0	125		
					1.42
					Each
					\$47.50

\*Standard blade - no hex bolster.



**347 92 Set 6 Pcs. Nut Driver Inch Sizes**

Item No.	Inch	Inch	Inch	Inch	lbs.
347 92	347 53	3/16	5.0	347 71	3/8
	347 59	1/4	5.0	347 74	7/16
	347 65	5/16	5.0	347 77	1/2
					1.94
					Each
					\$62.80



Made in Germany

Toll Free: (800) 494-6104

**Wiha SoftFinish® Nut Drivers - Hollow Shaft**



**343 Hollow Shaft Nut Driver-Wiha-SoftFinish® Handle. Inch sizes.**

Item No.	⊙ Inch	⊖ Inch	⊖ mm	⊖ mm	⊖ Inch	⊖ lbs.	⊖ pkg.	Each
343 36	3/16	3.0	70	175	7.0	.18	10	\$5.98
343 38	1/4	3.0	70	175	7.0	.24	10	\$5.98
343 39	5/16	3.0	70	182	7.0	.25	10	\$6.98
343 40	11/32	3.0	70	182	7.5	.25	10	\$6.98
343 41	3/8	3.0	70	182	7.5	.26	10	\$6.98
343 42	7/16	3.0	70	187	7.6	.38	10	\$7.98
343 43	1/2	3.0	70	187	7.6	.40	10	\$8.98



**343 90 Set 7 Pcs. Hollow Shaft Nut Driver Inch Sizes**

Item No.	⊙ Inch	⊖ Inch	⊙ Inch	⊖ Inch	⊖ lbs.	Each	
343 90	343 36	3/16	5.0	343 41	3/8	5.0	1.55
	343 38	1/4	5.0	343 42	7/16	5.0	
	343 39	5/16	5.0	343 43	1/2	5.0	Each
	343 40	11/32	5.0				\$49.78



**343 Hollow Shaft Nut Driver With Wiha-SoftFinish® Handle**

Item No.	⊙ mm	⊖ mm	⊖ mm	⊖ Inch	⊖ lbs.	⊖ pkg.	Each
343 02	5.0	70	175	8.5	.14	10	\$5.98
343 04	5.5	70	175	8.5	.14	10	\$5.98
343 06	6.0	70	175	8.5	.15	10	\$5.98
343 08	7.0	70	182	9.4	.25	10	\$6.98
343 10	8.0	70	182	9.4	.25	10	\$6.98
343 12	10.0	70	187	9.4	.27	10	\$7.98
343 14	13.0	70	187	9.7	.40	10	\$8.98



**343 91 Set 7 Pcs. Hollow Shaft Nut Driver Metric Sizes**

Item No.	⊙ mm	⊖ mm	⊙ mm	⊖ mm	⊖ lbs.	Each	
343 91	343 02	5.0	125	343 10	8.0	125	1.41
	343 04	5.5	125	343 12	10.0	125	
	343 06	6.0	125	343 14	13.0	125	Each
	343 08	8.0	125				\$48.78





Made in Germany

www.wihatools.com

Wiha T-Handle Nut Drivers



**336 Nut Driver, With Wiha T-handle** Blade CVM steel, hardened, nickel-plated. Wiha T-handle high quality plastic, impact resistant. Deep drawn 1" socket, solid shaft.

Item No.	mm	mm	mm	lbs.	pkg.	Each
336 03	6.0	125	100	.16	10	\$6.70
336 06	8.0	125	100	.18	10	\$6.70
336 07	8.0	200	100	.22	10	\$13.40
336 09	9.0	125	100	.23	10	\$6.80
336 12	10.0	125	100	.24	10	\$7.10
336 20	12.0	125	100	.26	10	\$7.20
336 22	13.0	125	100	.27	10	\$7.20



**336 Nut Driver, With Wiha T-handle** Blade CVM steel, hardened, nickel-plated. Wiha T-handle high quality plastic, impact resistant. Deep drawn 1" socket, solid shaft.

Item No.	Inch	Inch	Inch	lbs.	pkg.	Each
336 53	3/16	6.0	4.0	.16	10	\$5.90
336 59	1/4	6.0	4.0	.18	10	\$6.50
336 65	5/16	6.0	4.0	.19	10	\$6.50
336 71	3/8	6.0	4.0	.20	10	\$6.80
336 74	7/16	6.0	4.0	.26	10	\$7.10
336 77	1/2	6.0	4.0	.30	10	\$7.10



**339 Square Drive Socket Adapters, With Wiha-T-handle.** Blade CVM steel, hardened, chrome-plated, ball retainer. Wiha-T-handle high quality plastic, impact resistant.

Item No.	Size	mm	Inch	mm	Inch	lbs.	Each
339 00	1/4	150	6.0	80	3.0	.23	\$7.90
339 20	3/8	150	6.0	100	4.0	.23	\$13.80
339 50	1/2	150	6.0	100	4.0	.53	\$18.90



**336 90 Set 6 Pc. Nut Driver T-handle Inch Sizes** Blade CVM steel, hardened, nickel-plated. Wiha-T-handle high quality plastic, impact resistant. Deep drawn 1" socket, solid shaft.

Item No.	Inch	Inch	Inch	Inch	lbs.
336 90	336 53	3/16	6.0	336 71	3/8 6.0 1.58
	336 59	1/4	6.0	336 74	7/16 6.0 Each
	336 65	5/16	6.0	336 77	1/2 6.0 \$39.48



**336 91 Set 5 Pc. Nut Driver T-handle Metric Sizes** Blade CVM steel, hardened, nickel-plated. Wiha-T-handle high quality plastic, impact resistant. Deep drawn 1" socket, solid shaft.

Item No.	mm	mm	mm	mm	lbs.
336 91	336 03	6.0	125	336 12	10.0 125 1.57
	336 06	8.0	125	336 22	13.0 125 Each
	336 09	9.0	125		\$34.28



**388 00 Bit Holder With Wiha T-handle** Magnetic, holds bit and screw. Retainer out of stainless steel. Hex shaft chrome-vanadium-molybdenum steel, nickel-plated. Wiha-T-handle high quality plastic, impact resistant.

Item No.	Size	mm	Inch	mm	Inch	lbs.	pkg.	Each
388 00	1/4	150	6.0	80	3.0	.18	1	\$7.98



Made in Germany

Toll Free: (800) 494-6104

**Insulated Nut Drivers - SoftFinish® Handle**



**322** Nut Driver, With Wiha-SoftFinish® Handle Insulation According to ASTM F-1505-01, New VDE Specification 0682/part 201 and IEC 900,  $\Delta$  up to 1000 Volt. "GS" Sign. Individually Tested. Blade CVM steel, hardened. Insulation molded directly onto blade. Deep drawn 1" socket. Wiha-SoftFinish® handle, multi-component. Inch sizes

Item										
No.	Inch	Inch	mm	Inch	lbs.	pkg.	Each			
322 43	3/32	5.0	236	8.5	.14	10	\$6.80			
322 46	7/64	5.0	236	8.5	.14	10	\$6.80			
322 49	1/8	5.0	236	8.5	.14	10	\$6.80			
322 52	9/64	5.0	236	8.5	.15	10	\$7.70			
322 55	5/32	5.0	236	8.5	.15	10	\$7.70			
322 58	3/16	5.0	236	8.5	.15	10	\$7.90			
322 61	7/32	5.0	236	8.5	.16	10	\$7.90			
322 64	1/4	5.0	243	8.5	.24	10	\$7.90			
322 67	5/16	5.0	243	8.9	.25	10	\$9.50			
322 70	3/8	5.0	243	9.3	.26	10	\$10.70			
322 73	7/16	5.0	243	9.3	.36	10	\$11.60			
322 76	1/2	5.0	243	9.3	.39	10	\$12.20			
322 78	9/16	5.0	243	9.3	.39	10	\$12.40			
322 80	5/8	5.0	243	9.5	.41	10	\$13.70			



**322** Nut Driver, With Wiha-SoftFinish® Handle Insulation According to ASTM F-1505-01, New VDE Specification 0682/part 201 and IEC 900,  $\Delta$  up to 1000 Volt. "GS" Sign. Individually Tested. Blade CVM steel, hardened. Insulation molded directly onto blade. Deep drawn 1" socket. Wiha-SoftFinish® handle, multi-component. Metric Sizes

Item										
No.	mm	mm	mm	Inch	lbs.	pkg.	Each			
322 06	4.0	125	236	9.3	.15	10	\$7.70			
322 09	5.0	125	236	9.3	.16	10	\$7.90			
322 12	5.5	125	236	9.3	.16	10	\$7.90			
322 15	6.0	125	236	9.3	.16	10	\$7.90			
322 18	7.0	125	243	9.3	.25	10	\$8.90			
322 21	8.0	125	243	9.6	.25	10	\$9.50			
322 24	9.0	125	243	9.6	.25	10	\$10.70			
322 27	10.0	125	243	9.6	.27	10	\$11.30			
322 30	11.0	125	243	9.6	.37	10	\$11.60			
322 33	12.0	125	243	9.6	.38	10	\$11.90			
322 36	13.0	125	243	9.6	.39	10	\$12.20			



**322 92 Set 5 Pcs. Nut Driver Inch Sizes**

Item										
No.	Inch	Inch	Inch	Inch	lbs.					
322 92	322 61	7/32	5.0	322 70	3/8	5.0	1.52			
	322 64	1/4	5.0	322 76	1/2	5.0	Each			
	322 67	5/16	5.0				\$48.66			



**322 94 Set 7 Pcs. Nut Driver Inch Sizes**

Item										
No.	Inch	Inch	Inch	Inch	lbs.					
322 94	322 58	3/16	5.0	322 70	3/8	5.0	2.24			
	322 61	7/32	5.0	322 73	7/16	5.0				
	322 64	1/4	5.0	322 76	1/2	5.0	Each			
	322 67	5/16	5.0				\$69.98			



**322 91 Set 5 Pcs. Nut Driver Metric Sizes**

Item										
No.	mm	mm	mm	mm	mm	lbs.				
322 91	322 15	6.0	125	322 24	9.0	125	1.36			
	322 18	7.0	125	322 27	10.0	125	Each			
	322 21	8.0	125				\$48.76			



**322 93 Set 7 Pcs. Nut Driver Metric Sizes**

Item										
No.	mm	mm	mm	mm	mm	lbs.				
322 93	322 09	5.0	125	322 21	8.0	125	2.05			
	322 12	5.5	125	322 27	10.0	125				
	322 15	6.0	125	322 36	13.0	125	Each			
	322 18	7.0	125				\$66.98			



Made in Germany

www.wihatools.com

Wiha Open End Wrenches

**NEW**  
from Wiha

Made from 31CRV3 High Performance Tool Steel

Meets DIN 3110 / ISO10102 Specifications

Precision formed for an exact fit

Satin Chromed Sure Grip Body

The wrench specified by BMW, Mercedes & Rolls Royce

Polished heads

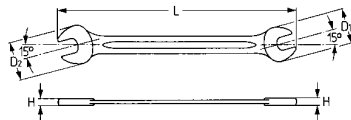
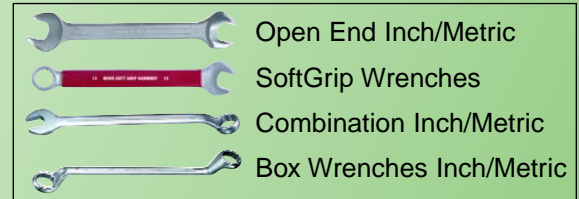

**350 Open End Wrenches Metric DIN 3110 / ISO 10102**

Made from 31CRV3 high performance tool steel. Satin chromed sure grip body. Polished Head. Precision formed for exact fit.

Item No.	mm	mm	OAL mm	OAL Inch	H mm	D <sup>1</sup> mm	D <sup>2</sup> mm	lbs.	pkg.	Each
35001	4.0 x 5.0	103	4.0	3.3	11.6	13.7	.02	10	\$6.98	
35002	5.0 x 5.5	104	4.1	3.3	13.7	14.7	.02	10	\$6.98	
35003	5.5 x 7.0	122	4.8	3.6	15.7	17.7	.04	10	\$6.98	
35004	6.0 x 7.0	122	4.8	3.6	15.7	17.7	.04	10	\$6.98	
35005	7.0 x 8.0	130	5.1	3.9	17.7	20.8	.06	10	\$6.98	
35006	8.0 x 9.0	140	5.5	3.9	20.8	22.9	.07	10	\$6.98	
35007	8.0 x 10.0	140	5.5	3.9	20.8	22.9	.07	10	\$6.98	
35008	10.0 x 11.0	156	6.1	4.8	23.9	26.9	.12	10	\$6.98	
35009	10.0 x 13.0	172	6.7	5.3	24.0	30.0	.15	10	\$7.98	
35010	12.0 x 13.0	172	6.7	5.3	28.0	31.0	.13	10	\$7.98	
35011	12.0 x 14.0	172	6.7	5.3	28.0	31.0	.13	10	\$7.98	
35012	13.0 x 14.0	190	7.5	5.7	32.5	34.9	.20	10	\$7.98	
35013	14.0 x 15.0	190	7.5	5.7	32.5	34.9	.20	10	\$8.98	
35014	16.0 x 17.0	204	8.0	5.9	36.1	39.2	.23	10	\$9.98	
35015	16.0 x 18.0	204	8.0	5.9	36.1	39.2	.23	10	\$10.98	
35016	18.0 x 19.0	223	8.7	6.5	40.2	42.3	.33	5	\$10.98	
35017	19.0 x 22.0	236	9.3	6.8	44.9	48.4	.42	5	\$11.98	
35018	20.0 x 22.0	236	9.3	6.8	44.9	48.4	.41	5	\$12.98	
35019	21.0 x 23.0	250	9.8	7.3	47.4	51.5	.58	5	\$13.98	
35020	22.0 x 24.0	250	9.8	7.3	47.4	51.5	.57	5	\$14.98	
35021	24.0 x 26.0	265	10.4	7.8	52.5	58.6	.70	5	\$15.98	
35022	24.0 x 27.0	265	10.4	7.8	52.5	58.6	.68	5	\$16.98	
35023	25.0 x 28.0	280	11.0	8.1	55.2	61.3	.77	1	\$17.98	
35024	27.0 x 29.0	280	11.0	8.1	58.6	64.4	.79	1	\$20.98	
35025	27.0 x 30.0	280	11.0	8.1	58.6	64.4	.78	1	\$21.98	
35026	30.0 x 32.0	302	11.8	8.6	64.8	70.3	1.06	1	\$22.98	
35027	32.0 x 36.0	325	12.7	8.8	66.5	74.5	1.21	1	\$35.98	
35028	36.0 x 41.0	358	14.0	8.8	74.5	84.0	1.61	1	\$48.98	
35029	46.0 x 50.0	450	17.6	10.8	93.5	105.0	3.23	1	\$88.98	

**350 Open End Wrenches Inch DIN 3110 / ISO 10102**

Made from 31CRV3 high performance tool steel. Satin chromed sure grip body. Polished Head. Precision formed for exact fit.

Item No.	Inch	Inch	OAL mm	OAL Inch	H mm	D <sup>1</sup> mm	D <sup>2</sup> mm	lbs.	pkg.	Each
35032	1/4 x 5/16	190	7.5	5.7	32.5	34.9	.20	10	\$6.98	
35033	5/16 x 3/8	204	8.0	5.9	36.1	39.2	.23	10	\$6.98	
35034	3/8 x 7/16	236	9.3	6.8	44.9	48.4	.45	10	\$6.98	
35035	7/16 x 1/2	250	9.8	7.3	47.4	51.5	.58	10	\$6.98	
35036	1/2 x 9/16	190	7.5	5.7	32.5	34.9	.20	10	\$7.98	
35037	9/16 x 5/8	190	7.5	5.7	32.5	34.9	.20	10	\$8.98	
35038	19/32 x 11/16	204	8.0	5.9	36.1	29.2	.24	10	\$9.98	
35039	5/8 x 11/16	204	8.0	5.9	36.1	29.2	.23	10	\$9.98	
35040	5/8 x 3/4	223	8.7	6.5	40.2	42.3	.34	5	\$10.98	
35041	11/16 x 3/4	223	8.7	6.5	40.2	42.3	.33	5	\$11.98	
35042	3/4 x 25/32	236	9.3	6.8	44.9	48.4	.42	5	\$11.98	
35043	3/4 x 7/8	236	9.3	6.8	44.9	48.4	.41	5	\$12.98	
35044	13/16 x 7/8	236	9.3	6.8	44.9	48.4	.40	5	\$13.98	
35045	7/8 x 15/16	250	9.8	7.3	47.4	51.5	.57	5	\$14.98	
35046	15/16 x 1	265	10.4	7.8	52.5	58.6	.68	5	\$16.98	
35047	1 x 1-1/8	280	11.0	8.1	55.7	61.3	.76	1	\$17.98	
35048	1-1/16x1-1/4	302	11.8	8.6	59.7	69.9	1.01	1	\$22.98	
35049	1-1/8x1-5/16	302	11.8	8.6	64.8	70.3	1.06	1	\$24.98	
35050	1-3/16x1-5/16	302	11.8	8.6	64.8	70.3	1.03	1	\$26.98	
35051	1-1/4 x 1-3/8	325	12.7	8.8	66.5	74.5	1.22	1	\$44.98	
35052	1-5/16x1-1/2	325	12.7	8.8	66.5	74.5	1.19	1	\$45.98	
35053	1-7/16x1-5/8	358	14.0	8.8	74.5	84.0	1.60	1	\$56.98	
35054	1-1/2 x 1-5/8	358	14.0	8.8	74.5	84.0	1.56	1	\$57.98	
35055	1-11/16x1-7/8	400	15.7	9.8	84.0	93.5	2.18	1	\$72.98	
35056	1-13/16 x 2	450	17.6	10.8	93.5	105.0	3.22	1	\$92.98	



Made in Germany

Toll Free: (800) 494-6104

**Wiha Heyco Open End Wrenches**



- Made from 31CRV3 high performance tool steel
- Satin chromed sure grip body
- Polished Head
- Precision formed for exact fit



- Made from 31CRV3 high performance tool steel
- Satin chromed sure grip body
- Polished Head
- Precision formed for exact fit



**350 90 Set 12 Piece Metric Open End Wrenches**

<b>Item No. 350 90 Includes:</b>	
4.0 x 5.0, 5.0 x 5.5, 6.0 x 7.0, 8.0 x 9.0, 10.0 x 11.0, 12.0 x 13.0, 14.0 x 15.0, 16.0 x 17.0, 18.0 x 19.0, 21.0 x 23.0, 20.0 x 22.0, 24.0 x 26.0	lbs. 3.30 <b>Each \$114.98</b>

**350 91 Set 11 Piece Inch Open End Wrenches In Tool Box**

<b>Item No. 350 91 Includes:</b>	
1/4x5/16, 3/8x7/16, 7/16x1/2, 1/2x9/16, 5/8x11/16, 3/4x25/32, 13/16x7/8, 15/16x1, 1x1-1/8, 1-1/16x1-1/4, 1-1/8x1-15/16"	lbs. 8.92 <b>Each \$144.98</b>



**350 92 Set 15 Piece Metric Open End Wrenches In tool box**

<b>Item No. 350 92 Includes:</b>	
6.0 x 7.0, 8.0 x 9.0, 10.0 x 11.0, 12.0 x 13.0, 14.0 x 15.0, 16.0 x 17.0, 18.0 x 19.0, 20.0 x 22.0, 21.0 x 23.0, 24.0 x 26.0, 25.0 x 28.0, 27.0 x 29.0, 30.0 x 32.0, 36.0 x 41.0, 46.0 x 50.0	lbs. 15.00 <b>Each \$299.98</b>

**350 93 Set 15 Piece Inch Open End Wrenches In tool box**

<b>Item No. 350 93 Includes:</b>	
1/4x5/16, 3/8x7/16, 7/16x1/2, 1/2x9/16, 5/8x11/16, 3/4x25/32, 13/16x7/8, 15/16x1, 1x1-1/8, 1-1/16x1-1/4, 1-1/8x1-15/16, 1-5/16x1-1/2, 1-7/16x1-5/8, 1-11/16x1-7/8, 1-13/16x2"	lbs. 17.7 <b>Each \$417.98</b>

**350 94 Set 10 Piece Metric Open End Wrenches**

<b>Item No. 350 94 Includes:</b>	
6.0 x 7.0, 8.0 x 9.0, 10.0 x 11.0, 12.0 x 13.0, 14.0 x 15.0, 16.0 x 17.0, 18.0 x 19.0, 20.0 x 22.0, 21.0 x 23.0, 24.0 x 26.0	lbs. 3.31 <b>Each \$111.98</b>

**350 95 Set 10 Piece Inch Open End Wrenches In tool box**

<b>Item No. 350 95 Includes:</b>	
3/8x7/16, 1/2x9/16, 5/8x11/16, 3/4x25/32, 13/16x7/8, 15/16x1, 1-1/16x1-1/4, 1-1/8x1-15/16, 1-1/4x1-3/8, 1-5/16x1-1/2"	lbs. 8.92 <b>Each \$144.98</b>



**350 96 Set 7 Piece Metric Open End Wrenches**

<b>Item No. 350 96 Includes:</b>	lbs. 1.50
6.0 x 7.0, 8.0 x 9.0, 10.0 x 11.0, 12.0 x 13.0, 14.0 x 15.0, 16.0 x 17.0, 18.0 x 19.0	<b>Each \$56.98</b>

**350 97 Set 7 Piece Inch Open End Wrenches**

<b>Item No. 350 97 Includes:</b>	lbs. 2.55
1/4x5/16, 3/8x7/16, 1/2x9/16, 5/8x11/16, 3/4x25/32, 13/16x7/8, 15/16x1"	<b>Each \$73.98</b>



**350 98 Set 5 Piece Metric Open End Wrenches**

<b>Item No. 350 98 Includes:</b>	lbs. .55
4.0 x 5.0, 5.0 x 5.5, 6.0 x 7.0, 8.0 x 9.0, 10.0 x 11.0	<b>Each \$33.98</b>

**350 99 Set 5 Piece Inch Open End Wrenches**

<b>Item No. 350 99 Includes:</b>	lbs. 2.55
3/8x7/16, 1/2x9/16, 9/16x5/8, 1/16x3/4, 13/16x7/8"	<b>Each \$73.98</b>



Made in Germany

www.wihatools.com

Wiha SoftGrip Wrenches

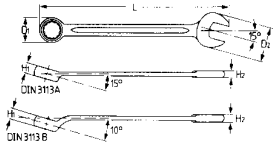

- Made from 31CRV3 high performance tool steel
- Soft grip body
- Polished Head
- Precision formed for exact fit

500 SoftGrip Wrenches Inch DIN 3113A/ISO 3318 - ISO 7738

Item No.	AF	OAL	OAL	H <sup>1</sup>	H <sup>2</sup>	D <sup>1</sup>	D <sup>2</sup>	Weight	lbs.	pkg.	Each
	mm	mm	Inch	mm	mm	mm	mm				
500 43	1/4	100	3.9	5.0	3.9	10.1	15.7	.03	10		\$10.98
500 44	5/16	120	4.7	5.9	4.4	12.9	19.0	.05	10		\$10.98
500 45	3/8	140	5.5	6.9	5.0	15.9	22.8	.09	10		\$11.98
500 46	7/16	150	5.9	7.4	5.2	17.3	25.4	.11	10		\$11.98
500 47	1/2	170	6.7	8.4	5.8	20.2	29.3	.14	10		\$12.98
500 48	9/16	180	7.1	8.9	6.1	21.6	31.2	.19	10		\$13.98
500 50	5/8	200	7.8	9.8	6.6	24.6	34.5	.23	10		\$14.98
500 51	11/16	210	8.2	10.3	6.9	25.9	37.3	.30	10		\$16.98
500 52	3/4	230	9.0	11.1	7.3	28.8	40.4	.34	5		\$18.98
500 54	13/16	250	9.8	11.7	7.7	31.7	44.2	.45	5		\$20.98
500 55	7/8	260	10.2	12.0	7.9	33.0	46.6	.51	5		\$22.98
500 56	15/16	280	11.0	12.7	8.3	35.8	50.1	.63	1		\$25.98
500 57	1	290	11.4	13.0	8.5	37.3	52.8	.65	1		\$26.98
500 58	1-1/16	310	12.2	13.6	8.9	40.2	55.9	.83	1		\$33.98
500 59	1-1/8	330	13.0	14.2	9.3	42.8	59.8	.98	1		\$36.98

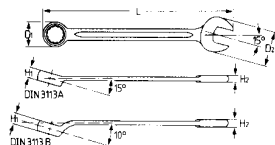

- Made from 31CRV3 high performance tool steel
- Soft grip body
- Polished Head
- Precision formed for exact fit

500 SoftGrip Wrenches Metric DIN 3113A/ISO 3318 - ISO 7738

Item No.	MM	OAL	OAL	H <sup>1</sup>	H <sup>2</sup>	D <sup>1</sup>	D <sup>2</sup>	Weight	lbs.	pkg.	Each
	mm	mm	Inch	mm	mm	mm	mm				
500 04	8.0	120	4.7	5.9	4.4	12.9	19.0	.05	10		\$10.98
500 05	9.0	130	5.1	6.4	4.7	14.5	20.9	.07	10		\$10.98
500 06	10.0	140	5.5	6.9	5.0	15.9	22.8	.09	10		\$11.98
500 07	11.0	150	5.9	7.4	5.2	17.3	25.4	.11	10		\$11.98
500 08	12.0	160	6.3	7.9	5.5	18.7	26.7	.13	10		\$11.98
500 09	13.0	170	6.7	8.4	5.8	20.2	29.3	.14	10		\$12.98
500 11	14.0	180	7.1	8.9	6.1	21.6	31.2	.19	10		\$13.98
500 12	15.0	190	7.5	9.3	6.3	23.1	33.0	.21	10		\$14.98
500 13	16.0	200	7.8	9.8	6.6	24.6	34.5	.23	10		\$15.98
500 14	17.0	210	8.2	10.3	6.9	25.4	37.3	.30	10		\$16.98
500 15	18.0	220	8.6	10.8	7.1	27.4	38.4	.32	10		\$17.98
500 16	19.0	230	9.0	11.1	7.3	28.8	40.4	.34	10		\$17.98
500 17	20.0	240	9.4	11.4	7.5	30.2	42.3	.39	5		\$19.98
500 19	22.0	260	10.2	12.0	7.9	33.0	46.6	.51	5		\$22.98
500 27	24.0	280	11.0	12.7	8.3	35.8	50.1	.62	5		\$26.98



500 89 Set 15 Piece Inch Combination Wrenches Roll up pouch

Item No. 500 89 Includes:	Each
1/4, 5/16, 3/8, 7/16, 1/2, 9/16, 5/8, 11/16, 3/4, 13/16, 7/8, 15/16, 1, 1-1/16, 1-1/8	\$293.98



500 95 Set 10 Piece Inch Combination Wrenches Roll up pouch

Item No. 500 95: 7/16, 1/2, 9/16, 5/8, 11/16, 3/4, 13/16, 7/8, 15/16, 1"	Each \$185.98
--	---------------



500 91 Set 12 Piece Inch Combination Wrenches Roll up pouch

Item No. 500 91 Includes:	Each
5/16, 3/8, 7/16, 1/2, 9/16, 5/8, 11/16, 3/4, 13/16, 7/8, 15/16, 1"	\$208.98



500 87 Set 15 Piece Inch Combination Wrenches Roll up pouch

Item No. 500 87 Includes:	Each
8, 9, 10, 11, 12, 13, 14, 15, 16, 17, 18, 19, 20, 22, 24mm	\$237.98



500 94 Set 10 Piece Inch Combination Wrenches Roll up pouch

Item No. 500 94 Includes: 10, 11, 12, 13, 14, 15, 16, 17, 18, 19mm	Each \$145.98
--	---------------



500 88 Set 12 Piece Inch Combination Wrenches Roll up pouch

Item No. 500 88 Includes: 8, 9, 10, 11, 12, 13, 14, 15, 16, 17, 18, 19mm	Each \$167.98
--	---------------





Made in Germany

Toll Free: (800) 494-6104

**Wiha Combination Wrenches**

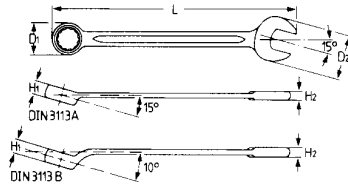

**400 Combination Wrenches Inch DIN 3113A/ISO 3318 - ISO 7738**

Made from 31CRV3 high performance tool steel. Satin chromed sure grip body. Polished Head. Precision formed for exact fit.

Item No.	AF	OAL	OAL	H <sup>1</sup>	H <sup>2</sup>	D <sup>1</sup>	D <sup>2</sup>	Weight	lbs.	pkg.	Each
	mm	mm	Inch	mm	mm	mm	mm				
400 43	1/4	100	3.9	5.0	3.9	10.1	15.7	.03	10		\$6.98
400 44	5/16	120	4.7	5.9	4.4	12.9	19.0	.05	10		\$6.98
400 45	3/8	140	5.5	6.9	5.0	15.9	22.8	.09	10		\$7.98
400 46	7/16	150	5.9	7.4	5.2	17.3	25.4	.11	10		\$7.98
400 47	1/2	170	6.7	8.4	5.8	20.2	29.3	.14	10		\$8.98
400 48	9/16	180	7.1	8.9	6.1	21.6	31.2	.19	10		\$9.98
400 49	19/32	190	7.5	9.3	6.3	23.1	33.0	.21	10		\$11.98
400 50	5/8	200	7.8	9.8	6.6	24.6	34.5	.23	10		\$11.98
400 51	11/16	210	8.2	10.3	6.9	25.9	37.3	.30	10		\$12.98
400 52	3/4	230	9.0	11.1	7.3	28.8	40.4	.34	5		\$14.98
400 53	25/32	240	9.4	11.4	7.5	30.2	42.3	.39	5		\$16.98
400 54	13/16	250	9.8	11.7	7.7	31.7	44.2	.45	5		\$17.98
400 55	7/8	260	10.2	12.0	7.9	33.0	46.6	.51	5		\$18.98
400 56	15/16	280	11.0	12.7	8.3	35.8	50.1	.63	5		\$21.98
400 57	1	290	11.4	13.0	8.5	37.3	52.8	.65	1		\$23.98
400 58	1-1/16	310	12.2	13.6	8.9	40.2	55.9	.83	1		\$28.98
400 59	1-1/8	330	13.0	14.2	9.3	42.8	59.8	.98	1		\$33.98
400 60	1-1/4	360	14.1	15.2	9.9	47.2	66.9	1.31	1		\$33.98
400 61	1-5/16	360	14.1	15.2	9.9	47.2	66.9	1.28	1		\$35.98
400 62	1-3/8	400	15.7	22.8	14.1	54.6	77.5	2.56	1		\$55.98
400 63	1-7/16	400	15.7	22.8	14.1	54.6	77.5	2.38	1		\$56.98
400 64	1-1/2	400	15.7	22.8	14.1	54.6	77.5	2.33	1		\$57.98
400 65	1-5/8	450	17.6	25.8	15.8	62.1	83.7	3.19	1		\$69.98
400 66	1-3/4	500	19.6	28.8	17.5	69.6	93.1	4.44	1		\$104.98
400 67	1-13/16	500	19.6	28.8	17.5	69.6	93.1	4.31	1		\$104.98
400 68	2	540	21.2	31.2	18.9	75.6	102.6	5.72	1		\$130.98

**400 89 Set 15 Piece Inch Combination Wrenches** Made from

31CRV3 high performance tool steel. Satin chromed sure grip body. Polished Head. Precision formed for exact fit. In roll up pouch.

Item No.	OAL	OAL
	Inch	Inch
400 43	1/4	100
400 44	5/16	120
400 45	3/8	140
400 46	7/16	150
400 47	1/2	170
400 48	9/16	180
400 50	5/8	200
400 51	11/16	210
400 52	3/4	230
400 54	13/16	250
400 55	7/8	260
400 56	15/16	280
400 57	1	290
400 58	1-1/16	310
400 59	1-1/8	330
\$230.98		



**400 91 Set 12 Piece Inch Combination Wrenches**

Made from 31CRV3 high performance tool steel. Satin chromed sure grip body. Polished Head. Precision formed for exact fit. In roll up pouch

Item No.	OAL	OAL
	Inch	Inch
400 44	5/16	120
400 45	3/8	140
400 46	7/16	150
400 47	1/2	170
400 48	9/16	180
400 50	5/8	200
400 51	11/16	210
400 52	3/4	230
400 54	13/16	250
400 55	7/8	260
400 56	15/16	280
400 57	1	290
\$169.00		



Made in Germany

www.wihatools.com

**Wiha Combination Wrenches**



**400 93 Set 7 Piece Inch Combination Wrenches**

Made from 31CRV3 high performance tool steel. Satin chromed sure grip body. Polished Head. Precision formed for exact fit.

Item No.	OAL		OAL	
	Inch	mm	Inch	mm
400 93	400 45	3/8 140	400 50	5/8 200
	400 46	7/16 150	400 51	11/16 210
lbs.	400 47	1/2 170	400 52	3/4 230
1.60	400 48	9/16 180	<b>Each \$74.98</b>	



**400 97 Set 15 Piece Inch Combination Wrenches** Made from 31CRV3 high performance tool steel. Satin chromed sure grip body. Polished Head. Precision formed for exact fit. In molded tool box.

Item No.	OAL		OAL	
	Inch	mm	Inch	mm
400 97	400 44	5/16 120	400 54	13/16 250
	400 45	3/8 140	400 55	7/8 260
	400 46	7/16 150	400 56	15/16 280
	400 47	1/2 170	400 57	1 290
lbs.	400 48	9/16 180	400 58	1-1/16 310
11.0	400 50	5/8 200	400 59	1-1/8 330
<b>Each</b>	400 51	11/16 210	400 60	1-1/4 360
<b>\$259.98</b>	400 52	3/4 230		



**400 95 Set 10 Piece Inch Combination Wrenches** In roll up pouch

Item No.	OAL		OAL	
	Inch	mm	Inch	mm
400 95	400 46	7/16 150	400 52	3/4 230
	400 47	1/2 170	400 54	13/16 250
lbs. 7.50	400 48	9/16 180	400 55	7/8 260
<b>Each</b>	400 50	5/8 200	400 56	15/16 280
<b>\$153.00</b>	400 51	11/16 210	400 57	1 290



**400 99 Set 26 Piece Inch Combination Wrenches With Tool Box**

Made from 31CRV3 high performance tool steel. Satin chromed sure grip body. Polished Head. Precision formed for exact fit.

Item No.	OAL		OAL	
	Inch	mm	Inch	mm
400 99	400 43	1/4 100	400 56	15/16 280
	400 44	5/16 120	400 57	1 290
	400 45	3/8 140	400 58	1-1/16 310
	400 46	7/16 150	400 59	1-1/8 330
	400 47	1/2 170	400 60	1-1/4 360
	400 48	9/16 180	400 61	1-5/16 360
	400 49	19/32 190	400 62	1-3/8 400
	400 50	5/8 200	400 63	1-7/16 400
	400 51	11/16 210	400 64	1-1/2 400
lbs.	400 52	3/4 230	400 65	1-5/8 450
38.5	400 53	25/32 240	400 66	1-3/4 500
<b>Each</b>	400 54	13/16 250	400 67	1-13/16 500
<b>\$899.98</b>	400 55	7/8 260	400 68	2 540



Made in Germany

Toll Free: (800) 494-6104

Wiha Combination Wrenches

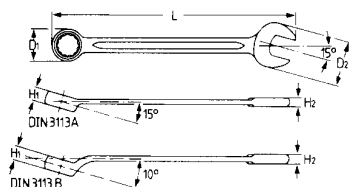

**400** Combination Wrenches Metric DIN 3113A/ISO 3318 - ISO 7738

Made from 31CRV3 high performance tool steel. Satin chromed sure grip body. Polished Head. Precision formed for exact fit.

Item No.	mm	OAL mm	OAL Inch	H1 mm	H2 mm	D <sup>1</sup> mm	D <sup>2</sup> mm	lbs.	pkg.	Each
400 01	5.5	100	3.9	5.0	3.0	10.1	15.7	.03	10	\$6.98
400 02	6.0	100	3.9	5.0	3.9	10.1	15.7	.03	10	\$6.98
400 03	7.0	110	4.3	5.5	4.2	11.5	17.0	.04	10	\$6.98
400 04	8.0	120	4.7	5.9	4.4	12.9	19.0	.05	10	\$7.98
400 05	9.0	130	5.1	6.4	4.7	14.5	20.9	.07	10	\$7.98
400 06	10.0	140	5.5	6.9	5.0	15.9	22.8	.09	10	\$8.98
400 07	11.0	150	5.9	7.4	5.2	17.3	25.4	.11	10	\$8.98
400 08	12.0	160	6.3	7.9	5.5	18.7	26.7	.13	10	\$8.98
400 09	13.0	170	6.7	8.4	5.8	20.2	29.3	.14	10	\$9.98
400 11	14.0	180	7.1	8.9	6.1	21.6	31.2	.19	10	\$10.98
400 12	15.0	190	7.5	9.3	6.3	23.1	33.0	.21	10	\$11.98
400 13	16.0	200	7.8	9.8	6.6	24.6	34.5	.23	10	\$11.98
400 14	17.0	210	8.2	10.3	6.9	25.4	37.3	.30	10	\$12.98
400 15	18.0	220	8.6	10.8	7.1	27.4	38.4	.32	10	\$13.98
400 16	19.0	230	9.0	11.1	7.3	28.8	40.4	.34	10	\$13.98
400 17	20.0	240	9.4	11.4	7.5	30.2	42.3	.39	5	\$15.98
400 18	21.0	250	9.8	11.7	7.7	31.7	44.2	.44	5	\$17.98
400 19	22.0	260	10.2	12.0	7.9	33.0	46.6	.51	5	\$18.98
400 20	23.0	270	10.6	12.4	8.1	34.5	48.8	.56	5	\$19.98
400 27	24.0	280	11.0	12.7	8.3	35.8	50.1	.62	5	\$22.98
400 28	25.0	290	11.4	13.0	8.5	37.3	52.8	.66	1	\$24.98
400 29	26.0	300	11.8	13.3	8.7	38.7	53.9	.74	1	\$24.98
400 30	27.0	310	12.2	13.6	8.9	40.2	55.9	.83	1	\$29.98
400 31	28.0	320	12.5	13.9	9.1	41.5	57.8	.88	1	\$30.98
400 32	29.0	330	12.9	14.2	9.3	42.8	59.8	.97	1	\$31.98
400 33	30.0	340	13.3	14.6	9.5	44.3	62.6	1.08	1	\$32.98
400 34	32.0	360	14.1	15.2	9.9	47.2	66.9	1.30	1	\$33.98
400 35	34.0	380	14.9	15.8	10.3	50.1	69.5	1.50	1	\$38.98
400 36	36.0	400	15.7	22.8	14.1	54.6	77.5	2.40	1	\$55.98
400 37	38.0	400	15.7	22.8	14.1	54.6	77.5	2.35	1	\$65.98
400 38	41.0	450	17.6	25.8	15.8	62.1	83.7	3.19	1	\$67.98
400 39	46.0	500	19.6	28.8	17.5	69.6	93.1	4.31	1	\$105.98
400 40	50.0	540	21.1	31.2	18.9	75.6	102.6	5.72	1	\$122.98

**400 87** Set 15 Piece Metric Combination Wrenches Made from

31CRV3 high performance tool steel. Satin chromed sure grip body. Polished Head. Precision formed for exact fit. In roll up pouch

Item No.	mm	OAL mm	mm	OAL mm		
400 87	400 04	8.0	120	400 13	16.0	200
	400 05	9.0	130	400 14	17.0	210
	400 06	10.0	140	400 15	18.0	220
	400 07	11.0	150	400 16	19.0	230
lbs.	400 08	12.0	160	400 17	20.0	240
6.75	400 09	13.0	170	400 19	22.0	260
Each	400 11	14.0	180	400 27	24.0	280
\$188.98	400 12	15.0	190			



**400 92** Set 26 Piece Metric Combination Wrenches In tool box

Item No.	mm	OAL mm	mm	OAL mm		
400 92	400 02	6.0	100	400 16	19.0	230
	400 03	7.0	110	400 17	20.0	240
	400 04	8.0	120	400 18	21.0	250
	400 05	9.0	130	400 19	22.0	260
	400 06	10.0	140	400 20	23.0	270
	400 07	11.0	150	400 27	24.0	280
	400 08	12.0	160	400 28	25.0	290
	400 09	13.0	170	400 29	26.0	300
	400 11	14.0	180	400 30	27.0	310
lbs.	400 12	15.0	190	400 31	28.0	320
15.3	400 13	16.0	200	400 32	29.0	330
Each	400 14	17.0	210	400 33	30.0	340
\$448.98	400 15	18.0	220	400 34	32.0	360



Made in Germany

www.wihatools.com

Wiha Combination Wrenches



**400 96 Set 15 Piece Metric Combination Wrenches** Made from 31CRV3 high performance tool steel. Satin chromed sure grip body. Polished Head. Precision formed for exact fit. In Molded tool box

Item No.	OAL		OAL	
	mm	mm	mm	mm
400 96	400 03	7.0 110	400 12	15.0 190
	400 04	8.0 120	400 13	16.0 200
	400 05	9.0 130	400 14	17.0 210
	400 06	10.0 140	400 15	18.0 220
lbs.	400 07	11.0 150	400 16	19.0 230
6.75	400 08	12.0 160	400 17	20.0 240
Each	400 09	13.0 170	400 18	21.0 250
<b>\$169.98</b>	400 11	14.0 180		

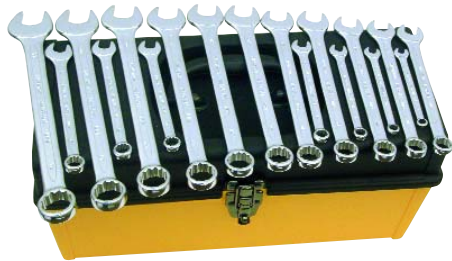

**400 98 Set 18 Piece Metric Combination Wrenches** In tool box Made from 31CRV3 high performance tool steel. Satin chromed sure grip body. Polished Head. Precision formed for exact fit.

Item No.	OAL		OAL	
	mm	mm	mm	mm
400 98	400 03	7.0 110	400 13	16.0 200
	400 04	8.0 120	400 14	17.0 210
	400 05	9.0 130	400 15	18.0 220
	400 06	10.0 140	400 16	19.0 230
	400 07	11.0 150	400 17	20.0 240
lbs.	400 08	12.0 160	400 18	21.0 250
8.7	400 09	13.0 170	400 19	22.0 260
Each	400 11	14.0 180	400 20	23.0 270
<b>\$231.98</b>	400 12	15.0 190	400 27	24.0 280



**400 86 Set 9 Piece Metric Combination Wrenches**

Made from 31CRV3 high performance tool steel. Polished Head.

Item No.	OAL		OAL	
	mm	mm	mm	mm
400 86	400 03	7.0 110	400 08	12.0 160
	400 04	8.0 120	400 09	13.0 170
lbs. 1.3	400 05	9.0 130	400 11	14.0 180
Each	400 06	10.0 140	400 12	15.0 190
<b>\$81.98</b>	400 07	11.0 150		



**400 88 Set 14 Piece Metric Combination Wrenches** Made from 31CRV3 high performance tool steel. Satin chromed sure grip body. Polished Head. Precision formed for exact fit. In pouch

Item No.	OAL		OAL	
	mm	mm	mm	mm
400 96	400 02	6.0 100	400 09	13.0 170
	400 03	7.0 110	400 11	14.0 180
	400 04	8.0 120	400 12	15.0 190
lbs.	400 05	9.0 130	400 13	16.0 200
2.3	400 06	10.0 140	400 14	17.0 210
Each	400 07	11.0 150	400 15	18.0 220
<b>\$130.00</b>	400 08	12.0 160	400 16	19.0 230

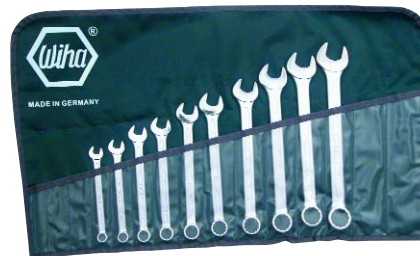

**400 94 Set 10 Piece Metric Combination Wrenches**

Made from 31CRV3 high performance tool steel. Satin chromed sure grip body. Polished Head. Precision formed for exact fit. In pouch

Item No.	OAL		OAL	
	mm	mm	mm	mm
400 94	400 06	10.0 140	400 12	15.0 190
	400 07	11.0 150	400 13	16.0 200
lbs. 2.3	400 08	12.0 160	400 14	17.0 210
Each	400 09	13.0 170	400 15	18.0 220
<b>\$114.00</b>	400 11	14.0 180	400 16	19.0 230



Made in Germany

Toll Free: (800) 494-6104

**Wiha Box Wrenches**

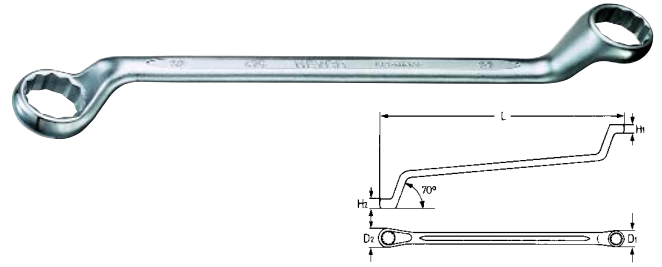
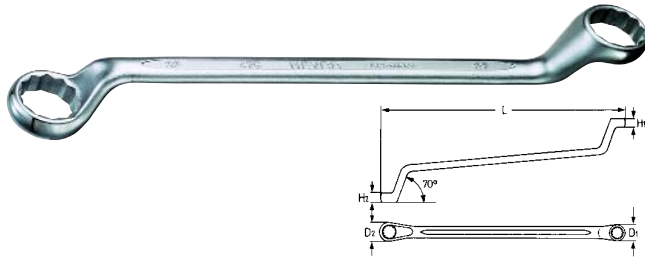

**475 Box Wrenches Metric DIN 838 / ISO 10104**

Satin chromed sure grip body. Made from 31CRV3 high performance forged tool steel. Precision formed for an exact fit. Polished head and ring. 12 point drive.

Item No.	mm	mm	OAL mm	OAL Inch	H <sup>1</sup> mm	H mm	D <sup>1</sup> mm	D <sup>2</sup> mm	lbs.	pkg.	Each
475 01	5.5 x 7.0	165	6.5	5.8	6.3	10.6	12.2	.09	10	\$9.98	
475 02	6.0 x 7.0	165	6.5	5.8	6.3	10.6	12.2	.09	10	\$9.98	
475 41	7.0 x 8.0	170	6.7	6.0	6.7	12.2	13.5	.12	10	\$9.98	
475 03	8.0 x 9.0	180	7.1	6.7	7.3	13.7	15.1	.13	10	\$9.98	
475 04	10.0 x 11.0	195	7.6	7.5	8.1	16.4	17.9	.19	10	\$10.98	
475 05	12.0 x 13.0	216	8.5	8.4	9.0	19.7	20.9	.26	10	\$11.98	
475 06	14.0 x 15.0	238	9.3	9.6	10.1	22.4	25.0	.33	10	\$12.98	
475 07	16.0 x 17.0	262	10.3	10.2	10.4	25.4	27.0	.44	10	\$13.98	
475 08	18.0 x 19.0	290	11.4	10.8	11.0	27.8	29.7	.55	5	\$15.98	
475 09	20.0 x 22.0	320	12.5	11.5	12.2	31.8	34.0	.75	5	\$17.98	
475 10	21.0 x 23.0	326	12.8	11.8	12.5	32.4	35.3	.77	5	\$20.98	
475 11	24.0 x 26.0	337	13.2	12.8	13.9	37.0	41.0	.92	5	\$24.98	
475 12	25.0 x 28.0	346	13.6	13.0	14.2	29.2	43.0	1.1	1	\$25.98	
475 13	27.0 x 29.0	346	13.6	13.9	14.6	40.5	45.3	1.1	1	\$31.98	
475 14	30.0 x 32.0	360	14.1	13.9	15.5	45.5	49.0	1.3	1	\$31.98	
475 15	30.0 x 34.0	380	14.9	14.8	16.5	45.5	51.8	1.3	1	\$33.98	
475 16	36.0 x 41.0	440	17.3	18.0	19.5	53.5	60.5	2.5	1	\$58.98	
475 17	46.0 x 50.0	500	19.6	21.4	22.4	67.0	73.0	3.6	1	\$117.98	

**475 Box Wrenches Inch DIN 838 / ISO 10104**

Satin chromed sure grip body. Made from 31CRV3 high performance forged tool steel. Precision formed for an exact fit. Polished head and ring. 12 point drive.

Item No.	Inch	Inch	OAL mm	OAL Inch	H <sup>1</sup> mm	H mm	D <sup>1</sup> mm	D <sup>2</sup> mm	lbs.	pkg.	Each
475 18	1/4x5/16	170	6.7	6.0	6.7	12.2	13.5	.12	10	\$11.98	
475 19	5/16x3/8	180	7.1	6.7	7.5	13.7	16.4	.14	10	\$11.98	
475 20	3/8x7/16	195	7.6	7.5	8.1	16.4	17.9	.19	10	\$12.98	
475 21	7/16x1/2	216	8.5	8.4	9.0	18.3	20.9	.24	10	\$13.98	
475 22	1/2x9/16	239	9.4	9.0	9.3	20.9	22.3	.32	10	\$13.98	
475 23	9/16x5/8	239	9.4	9.3	9.7	22.3	25.0	.32	10	\$13.98	
475 24	5/8x11/16	262	10.3	10.2	10.4	25.4	27.0	.42	10	\$14.98	
475 25	5/8x3/4	290	11.4	10.2	11.0	25.4	29.7	.51	10	\$16.98	
475 26	11/16x3/4	290	11.4	10.8	11.0	27.8	29.7	.58	5	\$16.98	
475 27	3/4x25/32	290	11.4	11.0	11.4	29.7	31.8	.57	5	\$16.98	
475 28	3/4x7/8	320	12.5	11.0	12.2	29.7	34.0	.67	5	\$19.98	
475 29	13/16x7/8	320	12.5	11.5	12.2	31.8	34.0	.69	5	\$20.98	
475 30	7/8x15/16	326	12.8	12.2	12.8	34.0	37.0	.77	5	\$22.98	
475 31	15/16x1	337	13.2	12.8	13.9	37.0	41.0	.98	1	\$26.98	
475 32	1x1-1/8	346	13.6	13.0	14.2	39.2	43.0	1.1	1	\$27.98	
475 33	1-1/16x1-1/4	358	14.0	13.9	15.5	42.0	49.0	1.3	1	\$32.98	
475 34	1-1/8x1-5/16	360	14.1	14.6	15.5	45.5	50.0	1.2	1	\$34.98	
475 35	1-3/16x1-5/16	360	14.1	14.6	15.5	45.5	50.0	1.3	1	\$36.98	
475 36	1-1/4x1-3/8	412	16.2	17.0	18.2	48.2	53.5	1.8	1	\$54.98	
475 37	1-5/16x1-1/2	412	16.2	17.0	18.2	48.2	53.5	1.8	1	\$54.98	
475 38	1-7/16x1-5/8	440	17.3	18.0	19.5	53.5	60.5	2.3	1	\$69.98	
475 39	1-11/16x1-7/8	476	18.7	19.7	21.4	63.0	70.0	2.8	1	\$89.98	
475 40	1-13/16x2	500	19.6	21.4	22.4	67.0	73.0	3.4	1	\$119.98	

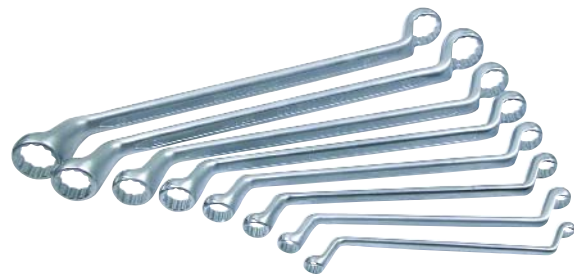
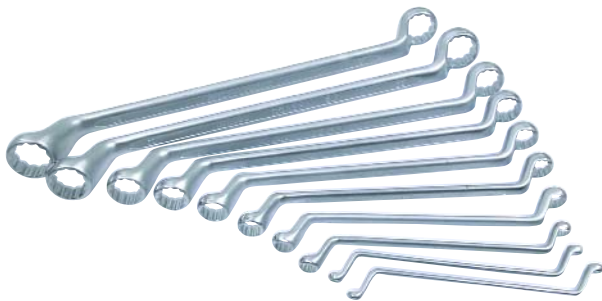

**475 90 Set 10 Piece Metric Box Wrenches**

Item No.	mm x mm	OAL mm	Item No.	mm x mm	OAL mm
475 90	475 01 5.5 x 7.0	165	475 06	14.0 x 15.0	238
↺	475 02 6.0 x 7.0	165	475 07	16.0 x 17.0	262
lbs. 3.95	475 03 8.0 x 9.0	180	475 08	18.0 x 19.0	290
Each	475 04 10.0 x 11.0	195	475 09	20.0 x 22.0	320
\$133.98	475 05 12.0 x 13.0	216	475 10	21.0 x 23.0	326

**475 91 Set 8 Piece Inch Box Wrenches**













Item No.	mm x mm	OAL mm	Item No.	mm x mm	OAL mm
475 91	475 18 1/4 x 5/16	170	475 25	5/8 x 3/4	290
↺	475 20 3/8 x 7/16	195	475 26	11/16 x 3/4	290
lbs. 2.55	475 21 7/16 x 1/2	216	475 29	13/16 x 7/8	320
Each	475 22 1/2 x 9/16	239			
\$120.98	475 23 9/16 x 5/8	239			











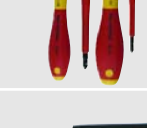

Made in Germany

www.wihatools.com

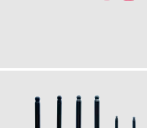
**Wiha Screwdrivers Index**

	Description	Page
	Orbit Phillips Drivers	63
	SoftFinish Slotted/Phillips Drivers	64-66
	SoftFinish Torx/TR Torx Drivers	15
	SoftFinish TorxPlus Drivers	24
	SoftFinish Pozidriv Drivers	67
	SoftFinish Square Drivers	67
	SoftFinish Nut Drivers	49-51
	SoftFinish Bit Holders	67,154
	ESD Safe SoftFinish Drivers Slotted/Phillips/Torx	68
	Universal Razor Edge Scraper	67
	Microfinish Slotted Drivers	69-70
	MicroFinish Phillips Drivers	69-70
	MicroFinish Torx Drivers	16
	MicroFinish Bit Holders	69,154
	ACO Slotted/Phillips Drivers	71
	3K Series Slotted/Phillips	72-73
	3K Series Torx Drivers	18
	3K Series Hex Drivers	41
	3K Series Bit Holders	73,154
	Protturn Torx Drivers	17
	Square Handle Slotted Drivers	74
	Square Handle Phillips Drivers	74
	Stubby Screwdrivers	66
	Dynamic Slotted/Phillips Drivers	75
	Magnetizer/Demagnetizer	75
	SYSTEM 6 Handles/Blades	76-78
	SYSTEM 6 Sets	77-79
	Topra Ratchet Handle	80,147
	Round Awls	80
	Square Reaming Awl	80
	Offset Slotted Screwdrivers	81
	Offset Phillips Screwdrivers	81

	Insulated Slotted Drivers	85
	Insulated Phillips Drivers	82-83
	Insulated Torx Drivers	85
	Insulated Nut Drivers	53,84
	Ins Retaining Ring Bit Holder	85,154
	Wing Handle Torx Driver	22
	Flag Handle Torx Driver	22
	Wing Handle TorxPlus Driver	25
	Torx/Hex/Nut Driver T-handles	21,38,52
	ComfortGrip T-handles L-keys	20
	Multi-Bit Screwdrivers	149
	Bit Holders	154
	ESD Safe Prec Slotted Drivers	111
	ESD Safe Prec Phillips Drivers	111
	ESD Safe Torx Drivers	111
	ESD Safe Prec Hex Drivers	112
	ESD Safe Prec Nut Drivers	112
	Precision Slotted Drivers	113-114
	Precision Phillips Drivers	113-114
	Precision Pozidriv Drivers	115
	Precision Hex Drivers	114
	Precision Ball End Drivers	115
	Precision Nut Drivers	116
	Precision Torx Drivers	117
	Precision Chip Lifters	117
	Protturn Prec Slotted Set	118
	Protturn Prec Combo Set	118
	Protturn Ball End Hex Set	119
	Protturn Prec Hex Set	119
	Protturn Prec Torx Set	120
	Protturn Chip Lifter	119
	SYSTEM 4 Handles/Blades	122-123
	SYSTEM 4 Sets	124-126
	MicroBits Handles/Blades/Sets	127-129



Made in Germany

Toll Free: (800) 494-6104

Wiha SoftFinish® Orbit Pivoting Phillips Drivers

Works On All Standard Phillips Head Screws

**NEW**  
From Wiha

Reach & turn Phillips screws  
at up to 20° angle with  
full 360° rotation

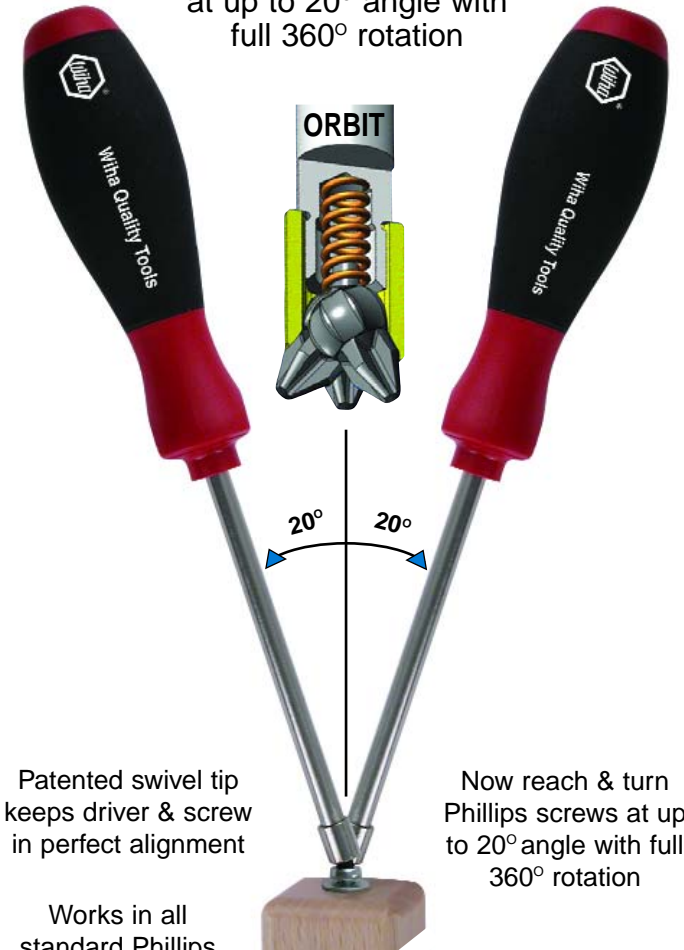
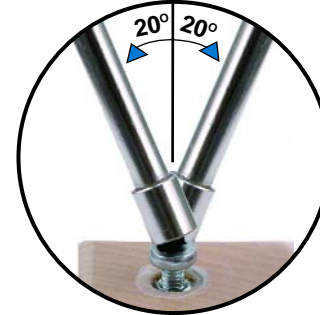

**2 Piece Orbit Driver Set**

- Includes #1 & #2 Phillips drivers
- Now reach and turn Phillips screws at up to 20° angle with full 360° rotation
- Easily access those hard to reach screws
- Patented swivel tip keeps driver & screw in perfect alignment, maintains full engagement
- Reduces cam out damage, screws & tools last longer
- Works on all standard Phillips Screws
- Ergonomic function allows natural wrist rotation
- Easily works around obstructions

**Saves Time!  
Improves Productivity!  
Makes The Job Easy!**

**Wiha Patented Design**

US Patent 6,575,062 B2

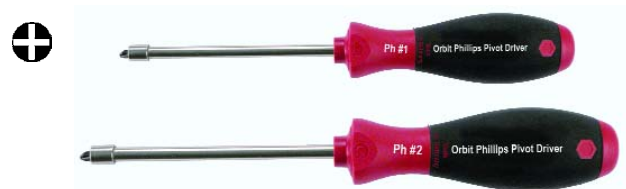

Item No.	Size	mm	Inch	mm	Inch	lbs.	pkg.	Each
311 68	1	80	3.0	191	7.5	1.64	10	\$9.98
311 69	2	100	4.0	218	8.6	2.27	10	\$10.98

Item No.	Size	mm	lbs.	Each
311 99	1	80	.45	\$19.98
	2	100		

**311 Wiha Orbit Pivot Drivers, With Wiha-SoftFinish® Handle**  
Hex blade high alloy chrome-vanadium-molybdenum steel, hardened, chrome-plated, Wiha-Chromtop finish on tips. Hex bolster for additional torque. Wiha-SoftFinish® handle, multi-component.

**311 99 Set 2 Pcs. Phillips Orbit Pivot Drivers**  
Hex blade, high alloy chrome-vanadium-molybdenum steel, hardened, chrome-plated. Hex bolster for additional torque. Wiha-Chromtop finish on tips. Wiha-SoftFinish® handle, multi-component.



Made in Germany

www.wihatools.com

Wiha SoftFinish® Handle - Ergonomic Cushion Grip

The Wiha SoftFinish® Handle: Featuring advanced technology dual material molding. A remarkable improvement in handle design, comfort and performance. The SoftFinish® ergonomic shape allows maximum torque and user comfort.

Wiha exclusive "SoftFinish® Zone" features solid molded core with soft outer cushion grip. Requires less force, yet achieves 40% more torque than conventional handles.

All blades are made of Wiha's exclusive formula chrome-vanadium-molybdenum tool steel, super hardened & chrome-plated for unmatched durability.

Wiha tips are precision machined to exact tolerances for a perfect fit every time.

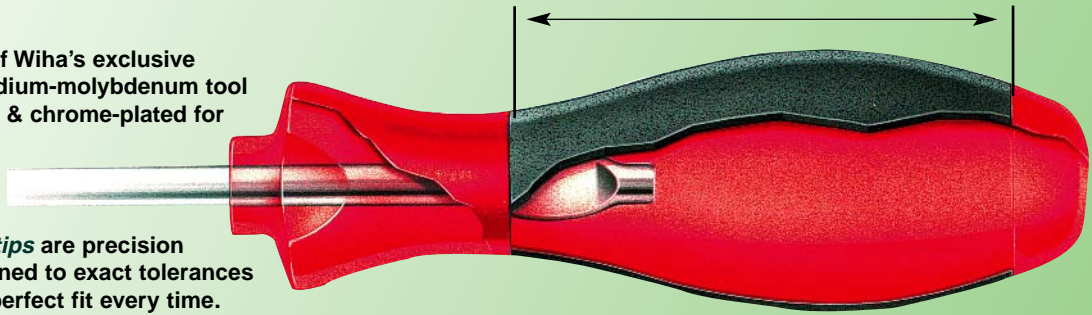

Handle is molded directly onto the blade for a permanent bond. Large optimized handle diameter allows higher torque with less user hand fatigue.

Wiha SoftFinish® Extra Heavy Duty



**530 Slotted Screwdriver, With Wiha-SoftFinish® Handle and Solid Metal Cap.** Hex blade extending through handle manufactured from high alloy chrome-vanadium-molybdenum steel, hardened, chrome-plated, Wiha-Chromtop finish on tips. Wiha-SoftFinish® handle, multi-component. Hex bolster for additional torque.

Item No.	mm	Inch	mm	Inch	mm	Inch	mm	Inch	lbs.	pkg.	Each
530 10*	3.5	.139	75	3.0	0.6	.024	186	7.3	.16	10	\$8.60
530 15*	4.5	.177	90	3.5	0.8	.031	201	7.9	.17	10	\$9.10
530 20	5.5	.196	100	4.0	1.0	.039	213	8.4	.23	10	\$11.10
530 25	6.5	.255	125	5.0	1.2	.047	238	9.4	.33	10	\$12.10
530 27	8.0	.315	150	6.0	1.2	.047	268	10.6	.56	10	\$16.80
530 35	10.0	.393	175	7.0	1.6	.063	293	11.6	.58	10	\$17.20
530 40	12.0	.472	200	8.0	2.0	.079	318	12.5	.76	10	\$18.20

\*No Hex Bolster



**531 Phillips Screwdriver, With Wiha-SoftFinish® Handle and Solid Metal Cap.** Hex blade extending through handle manufactured from high alloy chrome-vanadium-molybdenum steel, hardened, chrome-plated, Wiha-Chromtop finish on tips. Wiha-SoftFinish® handle, multi-component. Hex bolster for additional torque.

Item No.	Size	mm	Inch	mm	Inch	mm	Inch	lbs.	pkg.	Each
531 10	1	80	3.0	5.0	13/64	186	7.3	.20	10	\$9.10
531 15	2	100	4.0	6.0	1/4	213	8.4	.32	10	\$11.10
531 20	3	150	6.0	8.0	5/16	268	10.6	.56	10	\$15.10



530 90 Set 5 Pcs. Slotted & Phillips - Extra Heavy Duty

Item No.	mm	mm	Size	mm	lbs.		
530 90	530 20	5.5	100	531 10	1	80	1.79
	530 25	6.5	125	531 15	2	100	Each
	530 27	8.0	150				\$59.68



530 97 Set 7 Pcs. Slotted & Phillips - Extra Heavy Duty

Item No.	mm	mm	Size	mm	lbs.		
530 97	530 20	5.5	100	531 10	1	80	3.15
	530 25	6.5	125	531 15	2	100	
	530 27	8.0	150	531 20	3	150	Each
	530 35	10.0	175				\$91.68







Made in Germany

www.wihatools.com

Wiha SoftFinish® Handle - Standard Series



**302 Slotted Screwdriver, With Wiha-SoftFinish® Handle**

Round blade, high alloy CVM, hardened, chrome-plated, Wiha-Chromtop finish on tips. Wiha-SoftFinish® handle, multi-component.

Item No.	mm	Inch	mm	Inch	mm	Inch	mm	Inch	lbs.	pkg.	Each
302 05	3.0	.118	100	4.0	0.5	.020	204	8.0	.06	10	\$4.30
302 10	3.5	.139	100	4.0	0.6	.024	204	8.0	.07	10	\$4.60
302 15	4.0	.157	100	4.0	0.8	.031	211	8.3	.11	10	\$4.60
302 17	4.0	.157	150	6.0	0.8	.031	261	10.3	.12	10	\$4.80
302 20	5.5	.216	125	5.0	1.0	.039	236	9.3	.15	10	\$5.10
302 38	5.5	.216	300	11.8	1.0	.039	411	16.1	.24	10	\$7.30
302 23	6.5	.255	100	4.0	1.0	.039	218	8.6	.20	10	\$6.70
302 25	6.5	.255	150	6.0	1.2	.047	268	10.6	.22	10	\$6.90
302 27	8.0	.315	150	6.0	1.2	.047	274	10.8	.29	10	\$9.10
302 30	8.0	.315	175	7.0	1.2	.047	299	11.8	.30	10	\$9.10
302 35	10.0	.393	200	8.0	1.6	.063	324	12.8	.36	10	\$10.20
302 36	12.0	.472	250	9.8	2.0	.078	374	14.7	.52	10	\$14.00

**302 Stubby Slotted Screwdriver, With Wiha-SoftFinish® Handle**

Item No.	mm	Inch	mm	Inch	mm	Inch	mm	Inch	lbs.	pkg.	Each
302 39	4.0	.157	25	1.0	0.8	.031	75	2.95	.09	10	\$4.80
302 55	5.5	.216	25	1.0	1.0	.039	75	2.95	.09	10	\$6.00
302 65	6.5	.255	25	1.0	1.2	.047	75	2.95	.10	10	\$6.10



**311 Phillips Screwdriver, With Wiha-SoftFinish® Handle**

Round blade, high alloy CVM steel, hardened, chrome-plated, Wiha-Chromtop finish on tips. Wiha-SoftFinish® handle, multi-component.

Item No.	Size	mm	Inch	mm	Inch	mm	Inch	lbs.	pkg.	Each
311 05	0	60	2.4	3.0	.118	164	6.5	.06	10	\$3.60
311 10	1	80	3.0	4.5	.177	191	7.5	.11	10	\$4.90
311 12	1	200	8.0	4.5	.177	311	12.3	.15	10	\$6.60
311 14	1	300	12.0	4.5	.177	411	16.2	.18	10	\$9.60
311 15	2	100	4.0	6.0	.236	218	8.6	.20	10	\$6.60
311 17	2	200	8.0	6.0	.236	318	12.5	.25	10	\$7.10
311 18	2	300	12.0	6.0	.236	418	16.5	.30	10	\$8.00
311 20	3	150	6.0	8.0	.315	274	10.8	.33	10	\$9.10
311 25	4	200	8.0	10.0	.393	323	12.7	.51	10	\$14.30

**311 Stubby Phillips Screwdriver, With Wiha-SoftFinish® Handle**

Item No.	Size	mm	Inch	mm	Inch	mm	Inch	lbs.	pkg.	Each
311 35	1	25	1.0	4.5	.177	75	3.0	.09	10	\$4.30
311 40	2	25	1.0	6.0	.236	75	3.0	.10	10	\$4.80



**302 95 Set 5 Pcs. Slotted & Phillips**

Item No.	mm	mm	Size	mm	lbs.	Each	
302 95	302 05	3.0	100	311 10	1	80	1.02
	302 15	4.0	100	311 15	2	100	Each
	302 25	6.5	150				\$26.98



**302 94 Set 6 Pcs. Slotted & Phillips**

Round blade, high alloy CVM steel, hardened, chrome-plated. Wiha-Chromtop finish on tips. Wiha-SoftFinish® handle, multi-component.

Item No.	mm	mm	Size	mm	lbs.	Each	
302 94	302 15	4.0	100	311 10	1	80	1.29
	302 25	6.5	150	311 15	2	100	
	302 27	8.0	150				Each
	302 39	4.0	25				\$37.48

**302 98 Set 8 Pcs. Slotted & Phillips**

Round blade, high alloy CVM steel, hardened, chrome-plated. Wiha-Chromtop finish on tips. Wiha-SoftFinish® handle, multi-component.

Item No.	mm	mm	Size	mm	lbs.	Each	
302 98	302 05	3.0	100	311 10	1	80	1.87
	302 15	4.0	100	311 15	2	100	
	302 20	5.5	125	311 20	3	150	
	302 25	6.5	150				Each
	302 30	8.0	175				\$49.48



**302 97 Set 12 Pcs. Slotted & Phillips**

Round blade, high alloy CVM steel, hardened, chrome-plated. Wiha-Chromtop finish on tips. Wiha-SoftFinish® handle, multi-component.

Item No.	mm	mm	Size	mm	lbs.	Each	
302 97	302 05	3.0	100	311 05	0	60	2.48
	302 15	4.0	100	311 10	1	80	
	302 20	5.5	125	*311 40	2	25	
	302 25	6.5	150	311 15	2	100	
	*302 65	6.5	25	311 20	3	150	
	302 30	8.0	175				Each
	302 35	10	200				\$73.98

**302 99 Set 20 Pcs. Slotted, Phillips, TORX®, Square & Pozidriv®**

Item No.	Slotted	mm	mm	Phillips	Size	mm	TORX®	mm	mm
302 99	302 05	3.0	100	311 05	0	60	362 66	T6	60
	302 15	4.0	100	311 10	1	80	362 70	T8	60
	302 20	5.5	125	311 15	2	100	362 74	T10	80
	302 25	6.5	150				362 76	T15	80
	302 30	8.0	175				362 78	T20	100
							362 80	T25	100
							362 84	T30	115
									Each
									\$99.98

\*Stubby screwdriver with Wiha SoftFinish handle



Made in Germany

Toll Free: (800) 494-6104



**384 1/4" Bit Holding Screwdriver, With Wiha-SoftFinish® Handle**  
Magnetic, holds bit and screw. Retainer out of stainless steel. Shaft CVM steel, nickel-plated. Cushion grip handles.

Item	○	—	—	—	—	—	—	—	—
No.	Size	mm	Inch	mm	Inch	lbs.	pkg.	Each	
384 50	1/4"	125	5.0	240	9.5	.23	10	\$10.68	
384 60	1/4"	300	11.8	418	16.4	.33	10	\$17.98	

See additional bit holders on page 154



**384 90 Wiha-SoftFinish® Handle Bit Holder & Bit-Selector Set**  
Magnetic, holds bit and screw. Retainer out of stainless steel. Shaft chrome-vanadium-molybdenum steel, nickel-plated.

Set includes 1/4" magnetic bit holder and 6 of the following bits:

⦿	Slotted sizes: 5.5, 6.5mm	↔	Each
⊕	Phillips sizes: #0, #1, #2, #3	.53	\$19.98



**358 Square Screwdriver, With Wiha-SoftFinish® Handle**  
Round blade high alloy chrome-vanadium-molybdenum steel, hardened, chrome-plated, Wiha-Chromtop finish on tips. Wiha-SoftFinish® handle, multi-component, cushion grips.

Item	○	—	—	⦿	●	—	—	—	—	
No.	Size	mm	Inch	mm	Inch	mm	Inch	lbs.	pkg.	Each
358 01	1	100	4.0	4.5	5/32	210	8.2	.12	10	\$4.50
358 02	2	150	6.0	5.0	1/4	268	10.5	.19	10	\$4.90
358 03	3	150	6.0	6.0	1/4	268	10.5	.22	10	\$5.30



**313 Pozidriv® Screwdriver, With Wiha-SoftFinish® Handle**  
Round blade high alloy chrome-vanadium-molybdenum steel, hardened, chrome-plated, Wiha-Chromtop finish on tips. Wiha-SoftFinish® handle, multi-component, cushion grips.

Item	⊕	—	—	⦿	●	—	—	—	—	
No.	Size	mm	Inch	mm	Inch	mm	Inch	lbs.	pkg.	Each
313 05	0	60	2.4	3.0	.118	164	6.5	.06	10	\$4.70
313 10	1	80	3.0	4.5	.177	191	7.5	.11	10	\$5.60
313 12	1	200	7.8	4.5	.177	311	12.3	.15	10	\$7.30
313 15	2	100	4.0	6.0	.236	218	8.6	.20	10	\$7.30
313 20	3	150	6.0	8.0	.315	274	10.8	.33	10	\$10.90

Wiha Universal Razor Edged Scraper



SoftFinish  
"Cushion" Grip

**430 90 Universal Razor Edged Scraper, With Wiha-SoftFinish® Handle** Removes sealing material, glue residue, layers of film and labels. Includes item #43092 - 10 replacement blades.

Item	—	—	↔	—	
No.	mm	Inch	lbs.	pkg.	Each
430 90	170	6.7	.22	1	\$13.98

**430 40 Universal Razor Edged Scraper, With Wiha-SoftFinish® Handle** Removes sealing material, glue residue, layers of film, and labels. Handle only.

Item	—	—	↔	—	
No.	mm	Inch	lbs.	pkg.	Each
430 40	140	5.5	.15	10	\$10.98

**430 92 Replacement Blades for Universal Razor Edged Scraper**  
Package of 10 blades. Standard.

Item No.	↔	lbs.	Each
430 92	.07	\$3.98	



**430 93 Replacement Blades for Universal Razor Edged Scraper**  
Package of 10 blades. Standard.

Item No.	↔	lbs.	Each
430 93	.07	\$3.98	



**430 94 Replacement Blades for Universal Razor Edged Scraper**  
Package of 10 blades.

Item No.	↔	lbs.	Each
430 94	.07	\$3.98	



**430 95 Replacement Blades for Universal Razor Edged Scraper**  
Package of 10 blades.

Item No.	↔	lbs.	Each
430 95	.07	\$5.98	



**430 96 Replacement Blades for Universal Razor Edged Scraper**  
Package of 10 blades.

Item No.	↔	lbs.	Each
430 96	.07	\$3.98	



**430 97 Replacement Blades for Universal Razor Edged Scraper**  
Combo Pack. Package of 10 blades - 2 of each blade.

Item No.	↔	lbs.	Each
430 97	.07	\$4.98	

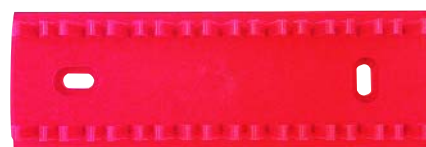

**900 00 Plastic Screwdriver Tool Rack** Rack holds all Wiha screwdrivers, with holes for hanging. Made from high quality plastic.

Item	↔	—	lbs.	pkg.	Each
900 00	Rack for Wiha screwdrivers 5.75 x 2"		.10	1	\$3.00



Made in Germany

www.wihatools.com

Wiha ESD Safe SoftFinish Cushion Grip Screwdrivers

For working on electrostatically sensitive components

Dissipative material  
Offers protection against electrostatic discharge

**NEW**  
from Wiha

SoftFinish cushion grip handle

Chrome-vanadium-molybdenum steel hardened, chrome-plated

DIN EN 61340-5-1/ 61340-5-2



**302 92 Set 6 Pcs. ESD Safe Slotted & Phillips**  
DIN EN 61340-5-1/ 61340-5-2 Round blade, high alloy CVM steel, hardened, chrome-plated. Dissipative SoftFinish® cushion grip handle, multi-component, ESD Safe (10<sup>6</sup>-10<sup>9</sup> Ohm).

Item No.	Slotted	Phillips	Size	mm	lbs.
302 42	3.0	.118	100	311 50 0 60	.96
302 44	4.0	.157	100	311 51 1 80	Each
302 46	5.5	.216	125	311 52 2 100	\$36.98



**302 ESD Safe Slotted Screwdrivers, With Wiha-SoftFinish® Handle**  
DIN EN 61340-5-1/ 61340-5-2 Round blade, high alloy CVM steel, hardened, chrome-plated. Offers protection against electrostatic discharge. Dissipative SoftFinish® cushion grip handle, multi-component, ESD Safe (10<sup>6</sup>-10<sup>9</sup> Ohm).

Item No.	Slotted	Phillips	Size	mm	Inch	mm	Inch	lbs.	pkg.	Each
302 40	2.5	.098	75	3.0	0.4	.016	175	7.0	.06	10 \$4.98
302 42	3.0	.118	100	4.0	0.5	.020	204	8.0	.06	10 \$5.48
302 44	4.0	.157	100	4.0	0.8	.031	211	8.3	.11	10 \$5.98
302 46	5.5	.216	125	5.0	1.0	.039	236	9.3	.15	10 \$6.98
302 48	6.5	.255	150	6.0	1.2	.047	268	10.6	.22	10 \$7.98



**362 ESD Safe TORX® Screwdriver, With Wiha-SoftFinish® Handle**  
DIN EN 61340-5-1/ 61340-5-2 Round blade, high alloy CVM steel, hardened, chrome-plated. Offers protection against electrostatic discharge. Dissipative SoftFinish® cushion grip handle, multi-component, ESD Safe (10<sup>6</sup>-10<sup>9</sup> Ohm).

Item No.	TORX	Size	mm	Inch	mm	Inch	lbs.	pkg.	Each
362 04	T4	60	2.4	3.5	.139	164	6.5	.06	10 \$5.98
362 06	T6	60	2.4	3.5	.139	164	6.5	.06	10 \$5.98
362 08	T8	60	2.4	3.5	.139	164	6.5	.06	10 \$5.98
362 09	T9	60	2.4	4.0	.157	171	6.7	.10	10 \$5.98
362 18	T10	80	3.0	4.0	.157	191	7.5	.11	10 \$5.98
362 19	T15	80	3.0	4.0	.157	191	7.5	.11	10 \$5.98
362 24	T20	100	4.0	4.0	.157	211	8.3	.11	10 \$5.98



**311 ESD Safe Phillips Screwdriver, With Wiha-SoftFinish® Handle**  
DIN EN 61340-5-1/ 61340-5-2 Round blade, high alloy CVM steel, hardened, chrome-plated. Offers protection against electrostatic discharge. Dissipative SoftFinish® cushion grip handle, multi-component, ESD Safe (10<sup>6</sup>-10<sup>9</sup> Ohm).

Item No.	Phillips	Size	mm	Inch	mm	Inch	lbs.	pkg.	Each
311 50	0	60	2.4	3.0	1/8	164	6.5	.06	10 \$5.68
311 51	1	80	3.0	4.5	3/16	191	7.5	.11	10 \$5.98
311 52	2	100	4.0	6.0	1/4	218	8.6	.20	10 \$6.98



**362 89 Set 6 Pcs. ESD Safe TORX® Screwdrivers**  
Round blade high alloy chrome-vanadium-molybdenum steel, hardened, Hard chrome finish with Wiha-Chromtop satin grip tips. Molded on SoftFinish® cushion grip handle, multi-component.

Item No.	TORX	Size	mm	TORX	Size	mm	lbs.
362 89	362 06	T6	60	362 18	T10	80	.81
	362 08	T8	60	362 19	T15	80	Each
	362 09	T9	60	362 24	T20	100	\$33.98



Made in Germany

Toll Free: (800) 494-6104

**Wiha MicroFinish Handle - Non-Slip Grip**

*Wiha MicroFinish handle* has a patented non-slip surface - it won't peel, crack or deteriorate when exposed to petroleum solvents. Oil and moisture flow away from the handle surface for a powerful, non-slip grip. You get maximum force and comfort with dry, oily or wet hands.

**Blade** Chrome-vanadium-molybdenum, hardened and tempered tool steel, gives exceptional tool life, wear resistance and high torque performance.

**Exact** fit precision ground tips.

**Blades** are hardened & chrome-plated.

**MicroFinish Handle** with patented non slip surface. Ergonomic handle shape for maximum comfort and exceptional torque transfer.

**Safe**, high density material, eliminates risk of sharp objects becoming embedded in the handle.



**520 Slotted Screwdriver, With Wiha-MicroFinish Handle**

Blade high alloy chrome-vanadium-molybdenum steel, hardened, chrome-plated. Wiha-MicroFinish handle, cellulose-acetate, impact resistant, non-slip, oil and grease resistant. Round blades.

Item No.	mm	Inch	mm	Inch	mm	Inch	mm	Inch	lbs	pkg.	Each
520 05	4.0	.157	100	4.0	0.8	.031	211	8.3	.16	10	\$5.70
520 10	4.0	.157	150	6.0	0.8	.031	261	10.3	.17	10	\$6.50
520 20	5.5	.216	125	5.0	1.0	.039	236	9.3	.20	10	\$6.40
520 25	5.5	.216	150	6.0	1.0	.039	261	10.3	.21	10	\$6.90
520 35	6.5	6.5	150	6.0	1.2	.047	268	10.6	.28	10	\$8.70
520 40	8.0	.315	150	6.0	1.2	.047	274	10.8	.37	10	\$11.10
520 50	10.0	.393	200	8.0	1.6	.063	324	12.8	.50	10	\$12.50



**521 Phillips Screwdriver, With Wiha-MicroFinish Handle**

Blade high alloy chrome-vanadium-molybdenum steel, hardened, chrome-plated. Wiha-MicroFinish handle, cellulose-acetate, impact resistant, non-slip, oil and grease resistant. Round blades.

Item No.	Size	mm	Inch	mm	Inch	lbs.	pkg.	Each
521 05	1	80	3.1	191	7.5	.15	10	\$6.30
521 10	1	200	8.1	311	12.2	.21	10	\$7.40
521 15	2	100	4.0	218	8.6	.26	10	\$8.50
521 20	2	200	8.0	318	12.5	.34	10	\$9.60
521 25	3	150	6.0	274	10.8	.41	10	\$11.70



**520 90 Set 5 Pcs. Slotted & Phillips**

Blade chrome-vanadium-molybdenum steel, hardened, chrome-plated. Wiha-MicroFinish handle, cellulose acetate, impact resistant, non-slip, oil and grease resistant.

Item No.	mm	mm	Size	mm	lbs.		
520 90	520 05	4.0	100	521 05	1	80	1.2
	520 20	5.5	125	521 15	2	100	Each
	520 40	8.0	150				\$37.60



**526 1/4" Bit holding Screwdriver, With Wiha-MicroFinish Handle**

Magnetic, holds bit and screw. Retainer out of stainless steel. Shaft chrome-vanadium steel, nickel-plated. Wiha-MicroFinish handle, cellulose-acetate, impact resistant, non-slip, oil and grease resistant.

Item No.	Size	mm	Inch	mm	Inch	lbs.	pkg.	Each
526 50	1/4	125	5.0	243	9.6	.24	10	\$13.80

See additional bit holders on page 154







Made in Germany

Toll Free: (800) 494-6104

Wiha ACO Slotted & Phillips Screwdrivers

# ACO

## Anti-Cam-Out Ribs

Anti-Cam-Out ribs give maximum grip in the screw head

Dual material handle has molded in soft grip panels & hang hole

Round blade made CVM special tool steel

Precision machined exact fit slotted tips ACO ribs

3K overdrive maximum comfort molded on ergonomic handle

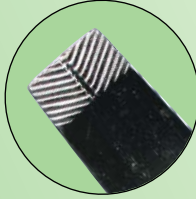

**469** ACO Slotted Screwdriver, With Wiha-3K Series Handle

Blade chrome-vanadium-molybdenum steel, hardened, nickel-plated. Wiha-3k Ergo handle, cushion grip.

Item No.	mm	Inch	mm	Inch	mm	Inch	mm	Inch	lbs.	pkg.	Each
469 12	4.5	.177	80	3.1	1.3	.050	186	7.3	.13	10	\$3.98
469 15	4.5	.177	150	6.0	1.3	.050	256	10.0	.16	10	\$4.98
469 21	6.0	.236	100	4.0	1.5	.058	218	8.5	.21	10	\$5.58
469 24	6.0	.236	150	6.0	1.5	.058	269	10.5	.23	10	\$5.98
469 33	8.0	.315	150	6.0	2.0	.078	269	10.5	.27	10	\$6.98



**469 91** Set 6 Pcs. Slotted & Phillips 3K ACO Soft Grip Set

Blade chrome-vanadium-molybdenum steel, hardened, nickel-plated. Wiha-3k Ergo handle, cushion grip.

Item No.	mm	mm	Size	mm	lbs.		
469 91	469 12	4.5	80	468 03	1	80	1.49
	469 21	6.0	100	468 06	1	150	Each
	469 33	8.0	150	468 12	2	100	\$32.48



**468** ACO Phillips Screwdriver, With Wiha-3K Series Handle

Blade chrome-vanadium-molybdenum steel, hardened, nickel-plated. Wiha-3k Ergo handle, cushion grip.

Item No.	Size	mm	Inch	mm	Inch	lbs.	pkg.	Each
468 03	1	80	3.1	186	7.3	.13	10	\$3.98
468 06	1	150	6.0	257	10.1	.15	10	\$4.98
468 12	2	100	4.0	218	8.5	.21	10	\$5.98
468 15	2	150	6.0	234	9.2	.23	10	\$6.98

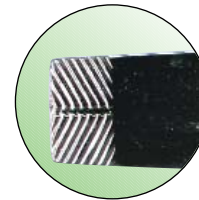

ACO Slotted

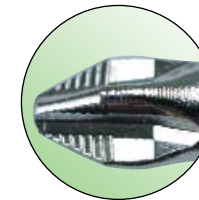

ACO Phillips



Made in Germany

www.wihatools.com

Wiha 3K Series Screwdrivers and Sets

# 3K Ergonomic Series Screwdrivers & Sets



Exact fit precision machined tips

Hole in handle for hanging

Dual material handle has molded soft grip panels

Blades made of chrome-vanadium-molybdenum tool steel, hardened, nickel-plated



**460 Slotted Screwdriver, With Wiha-3K Series Handle**  
Blade chrome-vanadium-molybdenum steel, hardened, nickel-plated.  
Wiha-3k Ergo handle, cushion grip.

Item No.	mm	Inch	mm	Inch	mm	Inch	mm	Inch	lbs.	pkg.	Each
460 60**	2.5	.098	75	3.0	0.4	.016	161	6.3	.06	10	\$3.30
460 70**	3.0	.118	100	4.0	0.5	.020	185	7.3	.07	10	\$3.30
460 72**	3.5	.139	100	4.0	0.6	.024	197	7.7	.09	10	\$3.80
460 74**	4.0	.157	100	4.0	0.8	.031	206	8.1	.12	10	\$3.80
460 75	4.5	.177	100	4.0	1.0	.039	207	8.1	.13	10	\$3.50
460 76	4.5	.177	150	6.0	1.0	.039	257	10.1	.14	10	\$4.20
460 77	4.5	.177	200	8.0	1.0	.039	306	12.0	.15	10	\$4.50
460 78	5.5	.216	125	5.0	1.0	.039	243	9.5	.19	10	\$3.90
460 80	6.0	.236	100	4.0	0.9	.035	218	8.5	.20	10	\$4.40
460 81	6.0	.236	150	6.0	0.9	.035	268	10.5	.23	10	\$4.90
460 82	6.0	.236	200	8.0	0.9	.035	318	12.5	.25	10	\$5.10
460 84*	6.5	.236	40	1.5	1.2	.047	90	3.5	.08	10	\$4.30
460 85	6.5	.236	150	6.0	1.2	.047	268	10.5	.23	10	\$5.20
460 87	8.0	.315	150	6.0	1.2	.047	268	10.5	.26	10	\$6.40
460 89	10.0	.393	200	8.0	1.6	.063	318	12.5	.35	10	\$6.70

\* Stubby screwdriver with Wiha Powerhandle - 46084  
\*\* Cabinet Tip



**461 Phillips Screwdriver, With Wiha-3K Series Handle**  
Blade chrome-vanadium-molybdenum steel, hardened, nickel-plated.  
Wiha-3k Ergo handle, cushion grip.

Item No.	mm	mm	Inch	mm	Inch	lbs.	pkg.	Each
461 47	0	60	2.4	145	5.7	.06	10	\$3.30
461 50	1	80	3.1	187	7.3	.13	10	\$3.70
461 51	1	200	8.0	307	12.0	.16	10	\$4.60
461 53	2	100	4.0	218	8.5	.21	10	\$5.00
461 52	2	150	6.0	268	10.5	.23	10	\$5.20
461 57	2	200	8.0	318	12.5	.25	10	\$5.30
461 62*	2	40	1.6	90	3.5	.08	10	\$3.90
461 67	3	150	6.0	268	10.5	.31	10	\$6.40

\* Stubby screwdriver with Wiha Powerhandle



**461 90 Set 6 Pcs. Phillips Screwdriver Set**  
Blade chrome-vanadium-molybdenum steel, hardened, nickel-plated.  
Wiha-3k Ergo handle, cushion grip.

Item No.	Size	mm	Size	mm	lbs.
461 90	461 47	0	60	461 52	2 150 1.27
	461 50	1	80	461 62	2 40 Each
	461 53	2	100	461 67	3 150 \$26.98





Made in Germany

Toll Free: (800) 494-6104

**Wiha 3K Series Screwdrivers and Sets**



**460 94 Set 6 Pcs. Slotted & Phillips**

Blade chrome-vanadium-molybdenum steel, hardened, nickel-plated. Wiha-3k Ergo handle, cushion grip.

Item No.	Slotted mm	Phillips mm	Size	mm	lbs.
460 94	460 70	3.0	100	461 50	1 80 .91
	460 75	4.5	100	461 52	2 150 <b>Each</b>
	460 78	5.5	125		<b>\$23.70</b>
	460 85	6.5	150		



**460 97 Set 8 Pcs. Slotted & Phillips**

Blade chrome-vanadium-molybdenum steel, hardened, nickel-plated. Wiha-3k Ergo handle, cushion grip.

Item No.	Slotted mm	Phillips mm	Size	mm	lbs.
460 97	460 70	3.0	100	461 50	1 80 1.70
	460 75	4.5	100	461 53	2 100
	460 80	6.0	100	461 62	2 40 <b>Each</b>
	460 87	8.0	150	461 67	3 150 <b>\$37.68</b>



**460 95 Set 5 Pcs. Slotted & Phillips**

Blade chrome-vanadium-molybdenum steel, hardened, nickel-plated. Wiha-3k Ergo handle, cushion grip.

Item No.	Slotted mm	Phillips mm	Size	mm	lbs.
460 95	460 75	4.5	100	461 47	0 60 1.04
	460 80	6.0	100	461 50	1 80 <b>Each</b>
				461 53	2 100 <b>\$20.40</b>



**460 98 Set 4 Pcs. Slotted & Phillips**

Blade chrome-vanadium-molybdenum steel, hardened, nickel-plated. Wiha-3k Ergo handle, cushion grip.

Item No.	Slotted mm	Phillips mm	Size	mm	.98 lbs.
460 98	460 75	4.5	100	461 50	1 80 <b>Each</b>
	460 80	6.0	100	461 53	2 100 <b>\$17.30</b>



**484 01 1/4" Bit holding Screwdriver, With Wiha-Ergo 3K Handle**  
Magnetic, holds bit and screw. Retainer out of stainless steel. Shaft CVM tool steel, nickel plated.

Item No.	Size	mm	Inch	mm	Inch	lbs.	pkg.	Each
484 01	1/4"	125	5.0	144	5.6	.24	1	<b>\$7.98</b>

**See Additional Bit Holders On Page 154**



Made in Germany

www.wihatools.com

Wiha Cabinet Tip and Screw Holding Screwdrivers



**186 Slotted Cabinet Tip Screwdriver, With Wiha-Square Handle**

Blade chrome-vanadium-molybdenum steel, hardened, nickel-plated. Tip parallel to shaft. Series includes extra long dimensions for screws in difficult to reach locations. Wiha-square handle cellulose-acetate, impact resistant.

Item	Icons	No.	mm	Inch	mm	Inch	mm	Inch	lbs.	pkg.	Each	
186 01		2.0	.078	40	1.6	0.40	.016	100	4.0	.02	10	\$2.00
186 03		2.5	.098	50	2.0	0.40	.016	110	4.3	.02	10	\$2.10
186 06		3.0	.118	75	3.0	0.50	.020	150	5.9	.05	10	\$2.30
186 09		3.0	.118	100	4.0	0.50	.020	175	6.9	.06	10	\$2.40
186 12		3.0	.118	150	6.0	0.50	.020	225	8.9	.06	10	\$2.50
186 15		3.0	.118	200	8.0	0.50	.020	285	11.2	.08	10	\$2.80
186 24		4.0	.157	100	4.0	0.60	.024	185	7.3	.08	10	\$2.90
186 27		4.0	.157	150	6.0	0.60	.024	235	9.3	.10	10	\$3.30
186 30		4.0	.157	200	8.0	0.60	.024	285	11.2	.11	10	\$3.90
186 42		5.0	.196	100	4.0	0.70	.028	195	7.7	.13	10	\$4.20
186 45		5.0	.196	150	6.0	0.70	.028	245	9.6	.15	10	\$4.20
186 48		5.0	.196	200	8.0	0.70	.028	295	11.6	.17	10	\$4.40
186 51		5.0	.196	300	12.0	0.70	.028	395	15.6	.20	10	\$5.00
186 54		6.0	.236	100	4.0	0.90	.035	205	8.1	.19	10	\$5.30
186 57		6.0	.236	150	6.0	0.90	.035	255	10.0	.21	10	\$5.80
186 60		6.0	.236	200	8.0	0.90	.035	305	12.0	.24	10	\$5.90
186 63		6.0	.236	300	12.0	0.90	.035	405	15.9	.29	10	\$6.40
186 72		8.0	.315	200	8.0	1.20	.047	315	12.4	.32	10	\$8.20
186 78		8.0	.315	300	12.0	1.20	.047	415	16.3	.39	10	\$9.10
186 81		10.0	.393	200	8.0	1.60	.063	315	12.4	.37	10	\$9.30



**153 Phillips Screwdriver, With Wiha-Square Handle**

Blade chrome-vanadium-molybdenum steel, hardened, nickel-plated. Wiha-square handle cellulose-acetate, impact resistant.

Item	Icons	No.	Size	mm	Inch	mm	Inch	mm	Inch	lbs.	pkg.	Each
153 05		0	60	2.4	3.0	.118	135	5.3	.05	10		\$2.80
153 10		1	80	3.0	4.5	.177	175	6.9	.11	10		\$4.10
153 15		1	200	8.0	4.5	.177	295	11.6	.15	10		\$5.10
153 25		2	100	4.0	6.0	.236	205	8.1	.18	10		\$5.50
153 30		2	250	10.0	6.0	.236	355	14.0	.27	10		\$7.30
153 35		2	350	13.7	6.0	.236	455	17.8	.33	10		\$8.30
153 40		3	150	6.0	8.0	.315	265	10.4	.33	10		\$8.00



**222 Pozidriv® Screwdriver, With Wiha-Square Handle**

Blade chrome-vanadium-molybdenum steel, hardened, nickel-plated. Wiha-square handle cellulose-acetate, impact resistant.

Item	Icons	No.	Size	mm	Inch	mm	Inch	mm	Inch	lbs.	pkg.	Each
222 20		1	200	7.8	4.5	.17	295	11.6	.15	10		\$6.70
222 30		2	250	9.8	6.0	.23	355	13.9	.27	10		\$7.70



Clamping sleeve to hold screw

**394 Slotted Screw-Holding Screwdriver, With Wiha-Square Handle**

Blade CVM steel, hardened, black finish. Clamping sleeve polyimide. Wiha-square handle cellulose-acetate, impact resistant.

Item	Icons	No.	mm	Inch	mm	Inch	mm	Inch	lbs.	pkg.	Each
394 25		2.5	.098	75	3.0	160	6.3	.07	10		\$12.90
394 30		3.0	.118	100	4.0	195	7.6	.11	10		\$13.50
394 40		4.0	.157	125	5.0	230	9.0	.18	10		\$17.40
394 50		5.0	.196	150	6.0	265	10.4	.25	10		\$20.70
394 60		6.0	.236	175	6.9	290	11.4	.30	10		\$23.50



Clamping sleeve to hold screw

**395 Phillips Screw-Holding Screwdriver, With Wiha-Square Handle**

Blade CVM steel, hardened, black finish. Clamping sleeve polyimide. Wiha-square handle cellulose-acetate, impact resistant.

Item	Icons	No.	Size	mm	Inch	mm	Inch	lbs.	pkg.	Each
395 00		0	100	4.0	195	7.6	.11	10		\$14.70
395 01		1	125	5.0	230	9.0	.18	10		\$20.20
395 02		2	175	7.0	290	11.4	.30	10		\$24.70

Wiha Offset Screwdrivers



**161 Phillips Offset Screwdriver, With Handle**

For working in confined spaces. Blade CVM special steel, hardened, chrome-plated. Handle high quality plastic, impact resistant.

Item	Icons	No.	Size	mm	Inch	mm	Inch	lbs.	pkg.	Each
161 12		1 + 2	125	4.9	5.5	.217	.08	10		\$4.40
161 34		3 + 4	200	10.0	8.0	.315	.33	10		\$10.30

**207 Slotted Offset Screwdriver, With Handle**

Item	Icons	No.	mm	Inch	mm	Inch	mm	Inch	lbs.	pkg.	Each
207 15		6.5	1/4	125	5.0	1.2	.047	.07	10		\$4.70
207 20		8.0	5/16	150	6.0	1.2	.047	.15	10		\$6.70
207 25		10.0	3/8	175	6.9	1.6	.063	.23	10		\$11.70



**207 90 5 Pc. Set Slotted & Phillips Offset Screwdrivers**

Item	Icons	Set includes the following drivers:		Each
207 90		lbs.	Slotted: 6.5, 8.0, 10.0	
207 90		.86	Phillips: 1 + 2, 3 + 4	\$36.98



Made in Germany

Toll Free: (800) 494-6104

**Wiha Dynamic Series**

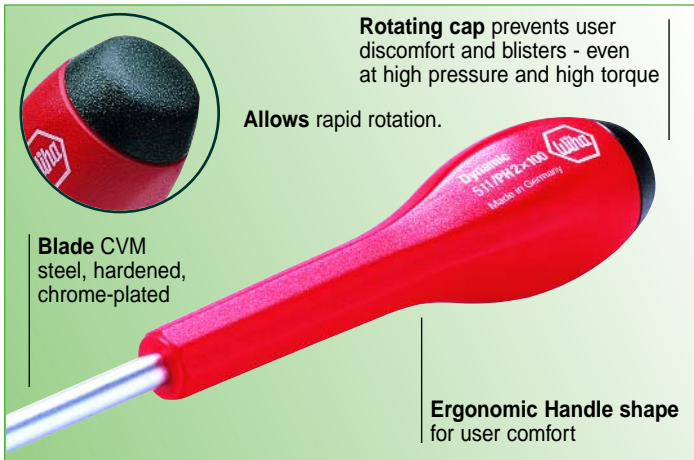

Rotating cap prevents user discomfort and blisters - even at high pressure and high torque

Allows rapid rotation.

Blade CVM steel, hardened, chrome-plated

Ergonomic Handle shape for user comfort



**510 Slotted Screwdriver, With Wiha-Dynamic Handle**

Blade high alloy chrome-vanadium-molybdenum steel, hardened, chrome-plated. Wiha-Dynamic-handle high quality plastic.

Item No.	mm	Inch	mm	Inch	mm	Inch	mm	Inch	lbs.	pkg.	Each
510 20	2.0	.078	65	2.5	0.4	.016	165	6.5	.04	10	\$4.90
510 25	2.5	.098	75	3.0	0.4	.016	175	6.9	.04	10	\$5.10
510 30	3.0	.118	80	3.1	0.5	.020	180	7.1	.05	10	\$5.40
510 35	3.5	.139	100	3.9	0.6	.024	205	8.1	.07	10	\$6.00
510 40	4.0	.157	100	3.9	0.8	.031	205	8.1	.08	10	\$6.50
510 55	5.5	.216	125	5.0	1.0	.039	236	9.3	.14	10	\$8.40
510 65	6.5	.255	150	6.0	1.2	.047	267	10.5	.20	10	\$10.20
510 80	8.0	.315	175	7.0	1.2	.047	267	11.6	.29	10	\$13.20

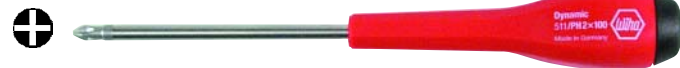

**511 Phillips Screwdriver, With Wiha-Dynamic Handle**

Item No.	Size	mm	Inch	mm	Inch	mm	Inch	lbs.	pkg.	Each
511 05	0	60	2.3	3.0	1/8	160	6.3	.05	10	\$5.80
511 10	1	80	3.1	4.5	3/16	191	7.5	.11	10	\$6.80
511 20	2	100	4.0	6.0	1/4	217	8.5	.17	10	\$9.10

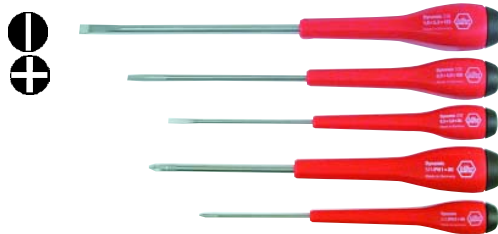

**510 90 Set 5 Pc. Slotted & Phillips, Wiha-Dynamic Handle**

Item No.	mm	Inch	mm	Inch	Size	mm	Inch	lbs.	pkg.	Each
510 90	3.0	.118	80	3.1	0	60	2.3	.68	1	\$33.06
	4.0	.157	100	3.9	1	80	3.1			
	5.5	.216	125	4.9						

**510 92 Set 4 Pc. Slotted Drivers, Wiha-Dynamic Handle**

Set Includes: 2.0, 3.5, 5.5, 6.5 Each \$28.98

**Wiha Magnetizer/Demagnetizer**

Magnetize or Demagnetize tools and small parts instantly.

Shatterproof Box is made from high quality plastic.

Uses 2 C5 industrial permanent magnets



(+) to Magnetize

(-) to Demagnetize

(Parts under 1" Length or 1/8" Diameter may not demagnetize)

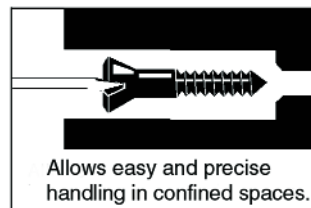

Allows easy and precise handling in confined spaces.

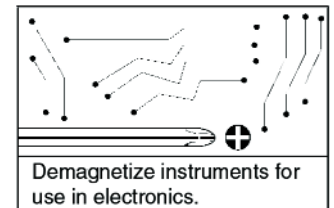

Demagnetize instruments for use in electronics.



Collects metal items from inaccessible places.

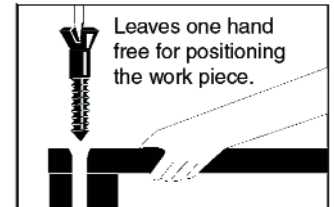

Leaves one hand free for positioning the work piece.

**400 10 Magnetizer and Demagnetizer**

To magnetize and demagnetize steel screwdriver blades, tweezers and similar tools. Box high quality plastic, shock-resistant, green, cadmium free.

**Application:**

To magnetize, lead tool slowly through the (+) opening, to demagnetize guide tool slowly through the (-) opening.



Item No.	Dimensions	lbs.	Each
400 10	2.1" x 2.0" x 1.1"	.30	\$7.18



Made in Germany

www.wihatools.com

# SYSTEM 6

## Handles • Blades • Sets

**Rotating cap** turns freely while applying pressure to tight fasteners.

**Collet lock** eliminates loose fitting blades.

**Narrow diameter** allows 40% more turning clearance. Gives high visibility to fastener.

**Long, slender grips** for extended reach



**108 10** SYS 6 Standard Dynamic Handle, high quality plastic, impact resistant.

**Advantages:**

- Accepts all SYSTEM 6 blades securely.
- Collet lock allows for quick & easy adjustment.

Item							
No.	mm	mm	Inch	mm	Inch	lbs.	Each
108 10	6.0	135	5.3	15.2	.60	.16	\$5.00



**108 20** SYSTEM 6 ESD Safe Dynamic Handle, Conductive, high quality plastic, impact resistant. **Advantages:**

- Accepts all SYSTEM 6 blades.
- Surface resistant 10<sup>6</sup> to 10<sup>9</sup> Ohms.
- Safe for working on ESD sensitive parts.
- Collet lock holds blade securely in place.

Item							
No.	mm	mm	Inch	mm	Inch	lbs.	Each
108 20	6.0	135	5.3	15.2	.60	.16	\$5.50



**108 30** SYSTEM 6 MicroFinish Non-Slip Grip Dynamic Handle, high quality plastic, impact resistant. **Advantages:**

- Accepts all SYSTEM 6 blades.
- MicroFinish Handle with non-slip surface.
- Collet lock holds blade securely in place.

Item							
No.	mm	mm	Inch	mm	Inch	lbs.	Each
108 30	6.0	135	5.3	15.2	.60	.16	\$6.00



**281 04** SYSTEM 6 Handle With Hex Bolster Wiha-SoftFinish® impact resistant. Hex bolster for additional torque.

**Advantages:**

- Ergonomic cushion grip
- Quick slide in blade change
- Hex bolster to loosen tight screws

Item						
No.	mm	mm	Inch	mm	Inch	Each
281 04	6.0	122	4.8	36.0	1.41	\$7.68



**481 06** SYSTEM 6 Magnetizer/Demagnetizer Handle. Wiha-Hex bolster for additional torque.

**Advantages:**

- Ergo Soft grip panels for comfort
- Built in blade Magnetizer/Demagnetizer

Item							
No.	mm	mm	Inch	mm	Inch	lbs.	Each
481 06	6.0	109	4.1	29	1.1	.14	\$11.98



**281 01** Magnetic T-handle for SYSTEM 6 Interchangeable Blades. Wiha T-handle impact resistant. **Advantages:**

- Ergo handle design for high torque capacity.
- Powerful rare earth magnet holds blade.

Item							
No.	mm	mm	Inch	mm	Inch	lbs.	Each
281 01	6.0	98.75	3.89	34	1.33	.12	\$5.98

### Smooth, high torque, silent ratchet handle

**Pistol Grip Handle** ergonomic design with free running mechanism. Instant clutch engagement allows constant turning pressure on the fastener.

**Hex Retainer** for SYSTEM 6 blades



**No release** of handle is needed, change of direction can be made with index finger and thumb. **Allows for** quick adjustment to right, left or fixed turning.

### Opens a new generation of easier torque transmission



**282 00** Topra Handle Pistol grip design. Wiha-Topra handle, high quality plastic, impact resistant. Rated to 200in/lbs. Fits all Wiha SYSTEM 6 blades.

Item							
No.	mm	mm	Inch	mm	Inch	lbs.	Each
282 00	6.0	100	3.94	85	3.35	.48	\$29.98

### SYSTEM 6 Starter Kit



**100 93** SYSTEM 6 Slotted & Phillips Interchangeable Blade Set, 6 Pcs. in Durable Pouch. Set includes SoftFinish® handle & 5 interchangeable blades.

Item				
No.	100 93	lbs.	.75	Each \$25.98
<b>Slotted:</b> 3.0, 4.5, 6.0mm <b>Phillips:</b> 1, 2				
Wiha SoftFinish® Dynamic Handle				
Pouch holds up to 11 SYSTEM 6 blades				



Made in Germany

Toll Free: (800) 494-6104

**Wiha SYSTEM 6 Blades**



**100 SYSTEM 6 Slotted Interchangeable**

Blade, high alloy CVM steel, hardened, corrosion protected. Slotted on 6mm SYSTEM 6 Hex. Blade length 140mm/5.5".

Item					
No.	mm	lbs.	pkg.	Each	
100 00	3.0	.10	1	\$4.68	
100 03	4.0	.10	1	\$4.68	
100 06	4.5	.10	1	\$4.68	
100 09	5.0	.10	1	\$4.68	
100 12	6.0	.10	1	\$4.68	
100 15	6.5	.10	1	\$4.68	
100 18	8.0	.10	1	\$4.68	



**101 SYSTEM 6 Phillips Interchangeable**

Blade, high alloy CVM steel, hardened, corrosion protected. Phillips on 6mm SYSTEM 6 Hex. Blade length 140mm/5.5".

Item					
No.	Size	lbs.	pkg.	Each	
101 00	0	.10	1	\$4.68	
101 03	1	.10	1	\$4.68	
101 06	2	.10	1	\$4.68	
101 09	3	.10	1	\$4.68	



**102 SYS 6 Pozidriv® Interchangeable**

Blade, high alloy CVM steel, hardened, corrosion protected. Pozidriv on 6mm SYSTEM 6 Hex. Blade length 140mm/5.5".

Item					
No.	Size	lbs.	pkg.	Each	
102 00	0	.10	1	\$5.48	
102 03	1	.10	1	\$5.48	
102 06	2	.10	1	\$5.48	
102 09	3	.10	1	\$5.48	



**103 SYS 6 Hex Inch Interchangeable**

Blade, high alloy CVM steel, hardened, corrosion protected. Hex Inch on 6mm SYSTEM 6 Hex. Blade length 140mm/5.5".

Item					
No.	Inch	lbs.	pkg.	Each	
103 00	3/32	.10	1	\$4.68	
103 03	7/64	.10	1	\$4.68	
103 06	1/8	.10	1	\$4.68	
103 09	9/64	.10	1	\$4.68	
103 12	5/32	.10	1	\$4.68	
103 15	3/16	.10	1	\$4.68	
103 18	7/32	.10	1	\$4.68	

**104 SYS 6 Hex Metric Interchangeable**

Item					
No.	mm	lbs.	pkg.	Each	
104 00	2.5	.10	1	\$4.68	
104 03	3.0	.10	1	\$4.68	
104 06	4.0	.10	1	\$4.68	
104 09	5.0	.10	1	\$4.68	
104 12	6.0	.10	1	\$4.68	



**105-106 SYS 6 Nut Driver Inch & Metric**

Interchangeable Blade, CVM steel, hardened, corrosion protected. Nut Drivers on 6mm SYSTEM 6 Hex. Blade length 140mm/5.5".

Item					
No.	mm	lbs.	pkg.	Each	
105 00	3/16	.11	1	\$5.30	
105 03	7/32	.11	1	\$5.30	
105 06	1/4	.12	1	\$5.30	
105 09	9/32	.12	1	\$5.30	
105 12	5/16	.13	1	\$5.30	
105 15	11/32	.13	1	\$5.30	
105 18	3/8	.14	1	\$5.30	
105 21	7/16	.16	1	\$5.30	
105 24	1/2	.18	1	\$5.30	

**Metric**

Item					
No.	mm	lbs.	pkg.	Each	
106 00	4.0	.10	1	\$5.30	
106 03	4.5	.10	1	\$5.30	
106 06	5.0	.11	1	\$5.30	
106 09	5.5	.11	1	\$5.30	
106 12	6.0	.11	1	\$5.30	
106 15	7.0	.13	1	\$5.30	
106 18	8.0	.13	1	\$5.30	
106 21	9.0	.13	1	\$5.30	
106 24	10.0	.15	1	\$5.30	
106 27	11.0	.15	1	\$5.30	
106 30	12.0	.15	1	\$5.30	
106 33	13.0	.17	1	\$5.30	

These blades can also be used in Topra Ratchet handle



**107 SYSTEM 6 TORX® Interchangeable**

Blade, high alloy CVM tool steel, hardened, corrosion protected. TORX® on 6mm SYS 6 Hex. Blade length 140mm/5.5".

Item					
No.	Size	lbs.	pkg.	Each	
107 00	T8	.10	1	\$4.68	
107 03	T9	.10	1	\$4.68	
107 06	T10	.10	1	\$4.68	
107 09	T15	.10	1	\$4.68	
107 12	T20	.10	1	\$4.68	
107 15	T25	.10	1	\$4.68	
107 18	T27	.10	1	\$4.68	
107 21	T30	.10	1	\$4.68	
107 24	T40	.11	1	\$4.68	

These blades can also be used in Topra Ratchet handle



**111 SYSTEM 6 Tamper Resistant TORX®**

Interchangeable Blade, high alloy CVM tool steel, hardened, corrosion protected. TORX® on 6mm SYS 6 Hex. Blade length 140mm/5.5".

Item					
No.	Size	lbs.	pkg.	Each	
111 03	TR7	.09	1	\$5.98	
111 05	TR8	.09	1	\$5.98	
111 07	TR9	.09	1	\$5.98	
111 09	TR10	.09	1	\$5.98	
111 12	TR15	.09	1	\$5.98	
111 15	TR20	.09	1	\$5.98	
111 18	TR25	.09	1	\$5.98	
111 20	TR27	.09	1	\$5.98	
111 24	TR30	.11	1	\$5.98	

**Magnetize & Demagnetize**



**Magnetize & Demagnetize**



**481 90 SYSTEM 6 Slotted & Phillips**

Interchangeable Blade Set, 7 Pcs. in Durable Pouch. Set includes Magnetizer/Demagnetizer handle & 6 interchangeable blades.

Item				
No.	481 90	lbs.	.75	Each \$36.98
<b>Slotted:</b>		3.0, 4.0, 6.0mm		
<b>Phillips:</b>		0, 1, 2		
Wiha Magnetizer/Demagnetizer Handle				



Made in Germany

www.wihatools.com

Wiha SYSTEM 6 Longer Length Blades



**284 SYSTEM 6 Slotted Reversible Blade**, high alloy CVM steel, hardened, chrome plated, Wiha vapor Chrome-Top finish on tips. Slotted on 6mm SYSTEM 6 Hex. Blade length 175mm/6.89".

Item				
No.	mm	mm	lbs.	Each
284 06	4.0	+ 6.0	.09	\$7.00
284 07	5.5	+ 6.5	.09	\$7.00



**284 SYSTEM 6 Phillips Reversible Blade**, high alloy CVM steel, hardened, chrome plated, Wiha vapor Chrome-Top finish on tips. Phillips on 6mm SYSTEM 6 Hex. Blade length 175mm/6.89".

Item				
No.	Size	Size	lbs.	Each
284 12	1	+ 2	.08	\$7.00



**284 SYSTEM 6 Pozidriv® Reversible Blade**, high alloy CVM steel, hardened, chrome plated, Wiha vapor Chrome-Top finish on tips. Pozidriv on 6mm SYSTEM 6 Hex. Blade length 175mm/6.89".

Item				
No.	Size	Size	lbs.	Each
284 22	1	+ 2	.08	\$7.00



**284 SYSTEM 6 Combined Hex Reversible Blade**, high alloy CVM steel, hardened, chrome plated, Wiha vapor Chrome-Top finish on tips. One side hex, other side ballpoint hex. Hex Metric on 6mm SYSTEM 6 Hex. Blade length 175mm/6.89".

Item				
No.	mm	mm	lbs.	Each
284 31	2.5	+ 2.5	.08	\$7.70
284 32	3.0	+ 3.0	.09	\$7.70
284 33	4.0	+ 4.0	.09	\$7.70
284 34	5.0	+ 5.0	.09	\$7.70
284 35	6.0	+ 6.0	.09	\$7.70



**284 SYS 6 Nut Driver Metric Blade**, high alloy CVM steel, hardened, chrome plated.

Item					
No.	mm	mm	mm	lbs.	Each
284 38	4.0	175	6.0	.09	\$6.60
284 41	5.5	175	6.0	.09	\$6.60
284 42	6.0	175	6.0	.09	\$6.60
284 43	7.0	176	6.0	.11	\$6.80
284 44	8.0	176	6.0	.12	\$6.80
284 46	10.0	177	6.0	.13	\$6.80
284 49	13.0	177	6.0	.16	\$7.00



**284 SYSTEM 6 TORX® Reversible Blade**, high alloy CVM steel, hardened, chrome plated, Wiha vapor Chrome-Top finish on tips. TORX® on 6mm SYSTEM 6 Hex. Blade length 175mm/6.89".

Item				
No.	Size	Size	lbs.	Each
284 51	T6	+ T8	.08	\$7.40
284 52	T7	+ T9	.08	\$7.40
284 53	T10	+ T15	.08	\$7.40
284 54	T20	+ T25	.08	\$7.40
284 55	T30	+ T40	.09	\$7.40



**284 SYSTEM 6 Combined Slotted/Phillips Reversible Blade**, high alloy CVM steel, hardened, chrome-plated, Wiha vapor Chrome-Top finish on tips. Slotted/Phillips on 6mm SYSTEM 6 Hex. Blade length 175mm/6.89".

Item				
No.	mm	Size	lbs.	Each
284 73	4.0	+ 1	.08	\$7.00
284 74	6.0	+ 2	.09	\$7.00
284 75	6.5	+ 3	.09	\$7.00

Wiha Adapter Blades



**109 00 Extension Blade for SYS 6 Blades** Shaft CVM steel, hardened, corrosion protected. Ball retainer blade extension. Allows you to extend all SYSTEM 6 blades an additional 100mm.

Item					
No.	Size	mm	mm	lbs.	pkg. Each
109 00	6.0	140	6.0	.13	1 \$5.20



**109 10 SYSTEM 6 Magnetic Adapter Blade for 1/4" Bits.** Shaft chrome-vanadium-molybdenum steel, hardened, corrosion protected. Bits retainer made from stainless steel.

Item					
No.	Size	mm	mm	lbs.	pkg. Each
109 10	1/4"	140	6.0	.12	1 \$5.20

**780 20 SYSTEM 6 Longer Length Magnetic Adapter Blade for 1/4" Bits.** Shaft chrome-vanadium-molybdenum steel, hardened, corrosion protected. Bits retainer made from stainless steel.

Item					
No.	Size	mm	mm	lbs.	pkg. Each
780 20	1/4"	170	6.0	.14	1 \$5.20



**109 20 SYSTEM 6 Adapter Blade for 1/4" Drive Sockets.** Shaft chrome-vanadium-molybdenum steel, hardened, chrome-plated, square drive with ball retainer.

Item					
No.	Size	mm	mm	lbs.	pkg. Each
109 20	1/4"	132	6.0	.13	1 \$5.20



**100 93 SYSTEM 6 Slotted & Phillips Interchangeable Blade Set, 6 Pcs. in Durable Pouch.** Set includes SoftFinish® handle & 5 interchangeable blades.

Item		
No.	100 93	lbs. .75 Each \$25.98
<b>Slotted:</b> 3.0, 4.5, 6.0mm <b>Phillips:</b> 1, 2		
Wiha SoftFinish® Dynamic Handle		



Made in Germany

Toll Free: (800) 494-6104

Wiha ESD Safe SYSTEM 6 Sets



**101 91 SYSTEM 6 Slotted & Phillips Interchangeable Blade Set, 8 Pcs. in Durable Pouch.** Set includes ESD Safe Collet Lock handle & 7 interchangeable blades.

Item			
No.	101 91	lbs. .75	Each \$32.98
Slotted:	3.0, 4.0, 6.0, 8.0mm		
Phillips:	0, 1, 2		
	▲ Wiha ESD Safe Dynamic Handle		



SYS 6    SYS 4

**107 91 SYSTEM 6/4 TORX® Interchangeable Blade Set, 9 Pcs. in Durable Pouch.** Set includes ESD Safe Precision and Dynamic handles and 7 Wiha interchangeable blades.

Item			
No.	107 91	lbs. .71	Each \$43.98
SYS 4:	T5, T6, T7, T8, T9, T10, T15		
SYS 6:	T20, T25, T30		
	▲ ESD Safe Precision & Dynamic Handle Set		

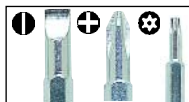

**101 95 SYSTEM 6 Slotted/Phillips & Tamper Resistant TORX® Interchangeable Blade Set, 12 Pcs. in Durable Pouch.** Set includes ESD Safe Collet Lock handle & 11 interchangeable blades.

Item			
No.	101 95	lbs. .92	Each \$53.98
Slotted:	3.0, 4.5, 6.0mm		
Phillips:	0, 1, 2		
TR TORX®:	TR7, TR8, TR9, TR10, TR15		
	▲ Wiha ESD Safe Dynamic Handle		



**109 51 SYSTEM 6 Inch Nut Drivers, Slotted & Phillips Interchangeable Blade Set, includes 4" Blade Extension, 14 Pcs. in Durable Pouch.** Set includes ESD Safe Dynamic Collet Lock handle and 13 Wiha interchangeable blades.

Item			
No.	109 51	lbs. 1.14	Each \$55.98
Slotted:	4.5, 6.5		
Phillips:	1, 2		
Nut Driver Inch:	3/16, 7/32, 1/4, 9/32, 5/16, 11/32, 3/8, 7/16, 1/2"		
	▲ ESD Safe Dynamic Handle		

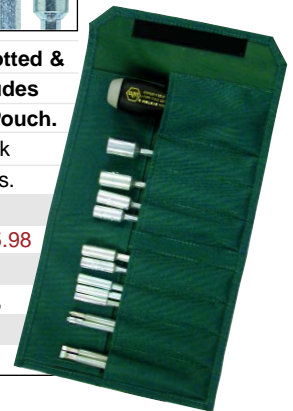

**106 91 SYS 6 Nut Driver Metric Interchangeable Blade Set, 11 Pcs. in Durable Pouch.** Set includes ESD Safe Collet Lock handle & 10 blades.

Item			
No.	106 91	lbs. 1.16	Each \$43.98
Metric:	4.0, 4.5, 5.0, 5.5, 6.0, 7.0, 8.0, 9.0, 10.0, 11.0mm		
	▲ Wiha ESD Safe Dynamic Handle		



**111 91 SYSTEM 6 Tamper Resistant TORX® Interchangeable Blade Set, 10 Pcs. in Durable Pouch.** Set includes ESD Safe Precision and Dynamic handles & 9 interchangeable blades.

Item			
No.	111 91	lbs. .84	Each \$53.98
Tamper Resistant:	TR7, TR8, TR9, TR10, TR15, TR20, TR25, TR27, TR30		
	▲ ESD Safe Dynamic Handle		





Made in Germany

www.wihatools.com

Wiha SYSTEM 6 Topra Set



Wiha Topra Ratchet Handle

282 Sets Topra Ratchet

Pistol Grip Handle with ergonomic design has free running mechanism. Instant clutch engagement allows constant turning pressure on the fastener.



282 94 Topra Reversible Set, 11 Pcs. in Metal Box. Wiha Topra Pistol Grip Ratchet handle fits SYSTEM 6 blades. 10 reversible longer length blades included.

Item	No.	Handle Description	Each
	282 94	Topra Ratcheting Handle	\$120.98
		<b>Longer Length (175mm) Reversible Blades:</b>	
		Slotted Sizes: 4.0 + 6.0, 5.5 + 6.5	
		Phillips Sizes: 1 + 2	
		Pozidriv® Sizes: 1 + 2	
		Hex/Ball Hex Sizes: 4.0 + 4.0, 5.0 + 5.0, 6.0 + 6.0	
		TORX® Sizes: T10 + T15, T20 + T25, T30 + T40	
		lbs. 3.18	



Wiha Awls and Offset Screwdrivers



300 01 Square Reaming Awl, With Hardwood Handle  
Blade chrome-vanadium-molybdenum steel, hardened, nickel-plated. Blade extending through handle, with striking plate. Hardwood handle out of beechwood.

Item	No.	mm	Inch	mm	Inch	mm	Inch	lbs.	pkg.	Each
	300 01	6.0	.236	100	4.0	190	7.5	.16	10	\$7.00



300 02 Square Reaming Awl, With Plastic Handle  
Blade chrome-vanadium-molybdenum steel, hardened, nickel-plated. Round handle cellulose-acetate, impact resistant.

Item	No.	mm	Inch	mm	Inch	mm	Inch	lbs.	pkg.	Each
	300 02	6.0	.236	100	4.0	185	7.3	.15	10	\$5.60



301 01 Round Awl, With Hardwood Handle  
Blade CVM steel, hardened, nickel-plated. Blade extending through handle, with striking plate. Hardwood handle out of beechwood.

Item	No.	mm	Inch	mm	Inch	mm	Inch	lbs.	pkg.	Each
	301 01	6.0	.236	100	4.0	190	7.5	.17	10	\$6.90



301 02 Round Awl, With Plastic Handle  
Blade chrome-vanadium-molybdenum steel, hardened, nickel-plated. Plastic handle cellulose-acetate, impact resistant.

Item	No.	mm	Inch	mm	Inch	mm	Inch	lbs.	pkg.	Each
	301 02	6.0	.236	100	4.0	185	7.3	.15	10	\$5.50







Made in Germany

www.wihatools.com

Wiha Insulated Screwdrivers with SoftFinish Cushion Grip Handle

Insulation Test Standards:

Insulation according to IEC 900, ASTM F-1505-01, New VDE 0682/part 201, DIN 7437, Draft 11/90

Responds to OSHA's use specification 29 CFR1910

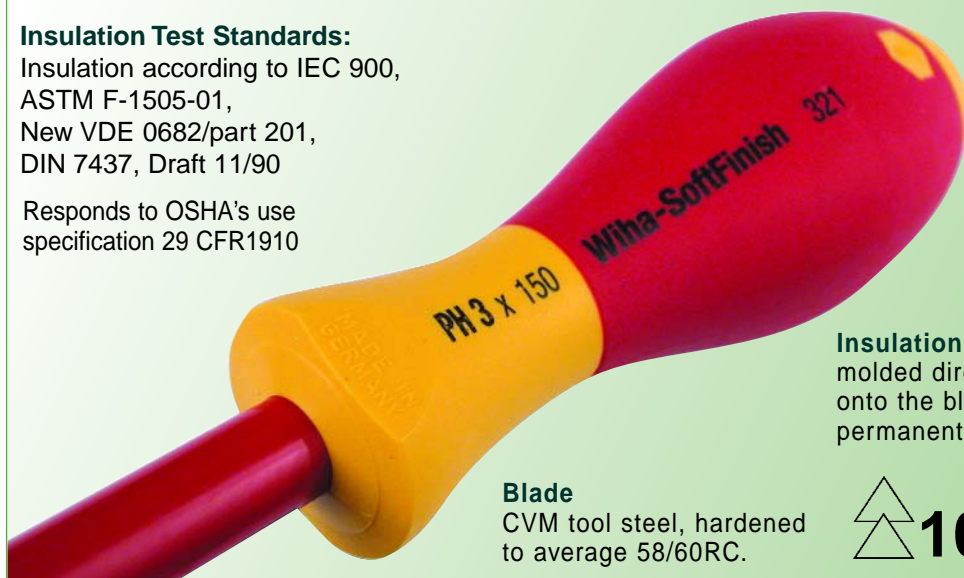

Each tool individually tested to 10,000 volts and certified to 1000 Volt ac or 1500 Volt dc.

SoftFinish® handle solid molded core with soft outer cushion grip. 40% more torque than conventional handles

Insulation molded directly onto the blade for permanent bonding.

Blade CVM tool steel, hardened to average 58/60RC.

1000V



1000Volt

**320 Slotted Screwdriver, With Wiha-SoftFinish® Handle**  
 Insulation According to ASTM F-1505-01, New VDE Specification 0682/part 201 and IEC 900, up to 1000 Volt. "GS" Sign.  
 Individually Tested. Blade high alloy chrome-vanadium-molybdenum steel, hardened, black finish. Insulation molded directly onto blade.  
 Wiha-SoftFinish® handle, multi-component, cushion grip.

Item	⊕	⊖	⊕	⊖	⊕	⊖	⊕	⊖	⊕	⊖
No.	mm	Inch	mm	Inch	mm	Inch	lbs.	pkg.	Each	
320 05	2.0	.078	60	3.0	164	6.5	.05	10	\$4.30	
320 10	2.5	.098	75	3.0	179	7.1	.06	10	\$4.30	
320 12	3.0	.118	100	4.0	204	8.0	.07	10	\$4.30	
320 15	3.5	.139	100	4.0	204	8.0	.07	10	\$4.60	
320 24	4.5	.177	125	5.0	236	9.3	.12	10	\$5.50	
320 26	5.5	.216	175	7.0	293	11.5	.21	10	\$6.20	
320 39	6.5	.255	150	6.0	268	10.6	.21	10	\$7.60	
320 42	8.0	.315	175	7.0	299	11.8	.34	10	\$9.70	
320 45	10.0	.393	200	8.0	318	12.5	.39	10	\$12.50	



1000Volt

**321 Phillips Screwdriver, With Wiha-SoftFinish® Handle**  
 Insulation According to ASTM F-1505-01, New VDE Specification 0682/part 201 and IEC 900, up to 1000 Volt. "GS" Sign.  
 Individually Tested. Blade high alloy chrome-vanadium-molybdenum steel, hardened, black finish. Insulation molded directly onto blade.  
 Wiha-SoftFinish® handle, multi-component, cushion grip.

Item	⊕	⊖	⊕	⊖	⊕	⊖	⊕	⊖	⊕	⊖
No.	Size	mm	Inch	mm	Inch	lbs.	pkg.	Each		
321 00	0	60	2.4	164	6.5	.06	10	\$4.60		
321 01	1	80	3.0	191	7.5	.12	10	\$5.30		
321 02	2	100	4.0	218	8.6	.20	10	\$6.70		
321 03	3	150	6.0	268	10.6	.34	10	\$9.50		

**Warning!**  
 Insulated tools are not intended for use on live or energized circuits. Always disconnect and de-energize all equipment & circuits. **NEVER!** work on live or energized circuits or equipment.

**Use & Care Guide For Insulated Tools:**  
 Store tools to minimize risk of damage to insulation  
 Inspect insulation prior to each use of any insulated tool  
 If you doubt the integrity of the insulation destroy the tool or have it retested  
 Use insulated tools where the ambient temperature is between -20 to +70° C  
 Have a qualified safety technician inspect and re-certify tools annually for safe use



Made in Germany

Toll Free: (800) 494-6104

**Wiha Insulated Screwdriver Sets**



⚠️ 1000Volt

**320 90 Set 4 Pcs. Slotted & Phillips**

Item No.	Slotted (mm)	Phillips (mm)	Size	Weight (lbs.)
320 90	320 15	3.5 100 0.6	321 01 1 80	.76 lbs.
	320 24	4.5 125 1.0	321 02 2 100	Each \$22.98

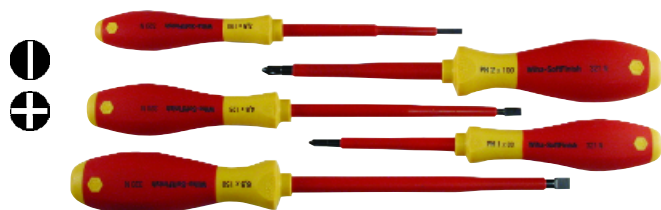

⚠️ 1000Volt

**320 91 Set 5 Pcs. Slotted & Phillips**

Item No.	Slotted (mm)	Phillips (mm)	Size	Weight (lbs.)
320 91	320 12	3.0 100 0.6	321 01 1 80	1.31
	320 24	4.5 125 1.0	321 02 2 100	Each \$28.80
	320 39	6.5 150 1.2		



⚠️ 1000Volt

**320 92 Set 6 Pcs. Slotted & Phillips**

Item No.	Slotted (mm)	Phillips (mm)	Size	Weight (lbs.)
320 92	320 15	3.5 100 0.6	321 01 1 80	1.31
	320 24	4.5 125 1.0	321 02 2 100	Each \$38.70
	320 39	6.5 150 1.2	321 03 3 150	



⚠️ 1000Volt

**320 93 Set 10 Pcs. Slotted & Phillips**

Item No.	Slotted (mm)	Phillips (mm)	Size	Weight (lbs.)
320 93	320 05	2.0 60	321 00 0 60	1.63
	320 10	2.5 75	321 01 1 80	
	320 12	3.0 100	321 02 2 100	
	320 15	3.5 100	321 03 3 150	
	320 24	4.5 125		Each \$49.98
	320 39	6.5 150		

⚠️ 1000Volt



**321 90 Set 15 Pcs. Slotted, Phillips & Inch Nut Drivers**

Item No.	Slotted (mm)	Phillips (mm)	Size	Weight (lbs.)
321 90	321 01	1 80	320 42 8.0 175	6.0
	321 02	2 100	320 39 6.5 150	
	321 03	3 150	320 24 4.5 125	
			320 15 3.5 100	
	322 64	1/4 5.0	320 12 3.0 100	
	322 67	5/16 5.0	320 10 2.5 75	
	322 70	3/8 5.0	320 05 2.0 60	
	322 73	7/16 5.0		Each \$155.98
	322 76	1/2 5.0		



Made in Germany

www.wihatools.com

Wiha Insulated Nut Drivers



1000Volt

**322** Nut Driver, With Wiha-SoftFinish® Handle Insulation According to ASTM F-1505-01, New VDE Specification 0682/part 201 and IEC 900, up to 1000 Volt. "GS" Sign. Individually Tested.

Blade CVM steel, hardened. Insulation molded directly onto blade. Deep drawn 1" socket. Wiha-SoftFinish® handle, multi-component.

Item No.	mm	mm	mm	Inch	lbs.	pkg.	Each
322 06	4.0	125	236	9.3	.15	10	\$7.70
322 09	5.0	125	236	9.3	.16	10	\$7.90
322 12	5.5	125	236	9.3	.16	10	\$7.90
322 15	6.0	125	236	9.3	.16	10	\$7.90
322 18	7.0	125	243	9.3	.25	10	\$8.90
322 21	8.0	125	243	9.6	.25	10	\$9.50
322 24	9.0	125	243	9.6	.25	10	\$10.70
322 27	10.0	125	243	9.6	.27	10	\$11.30
322 30	11.0	125	243	9.6	.37	10	\$11.60
322 33	12.0	125	243	9.6	.38	10	\$11.90
322 36	13.0	125	243	9.6	.39	10	\$12.20



1000Volt

**322** Nut Driver, With Wiha-SoftFinish® Handle. Inch sizes.

Item No.	Inch	Inch	mm	Inch	lbs.	pkg.	Each
322 43	3/32	5.0	236	8.5	.14	10	\$6.80
322 46	7/64	5.0	236	8.5	.14	10	\$6.80
322 49	1/8	5.0	236	8.5	.14	10	\$6.80
322 52	9/64	5.0	236	8.5	.15	10	\$7.70
322 55	5/32	5.0	236	8.5	.15	10	\$7.70
322 58	3/16	5.0	236	8.5	.15	10	\$7.90
322 61	7/32	5.0	236	8.5	.16	10	\$7.90
322 64	1/4	5.0	243	8.5	.24	10	\$7.90
322 67	5/16	5.0	243	8.9	.25	10	\$9.50
322 70	3/8	5.0	243	9.3	.26	10	\$10.70
322 73	7/16	5.0	243	9.3	.36	10	\$11.60
322 76	1/2	5.0	243	9.3	.39	10	\$12.20
322 78	9/16	5.0	243	9.3	.39	10	\$12.40
322 80	5/8	5.0	243	9.5	.41	10	\$13.70

**Warning!**

Insulated tools are not intended for use on live or energized circuits. Always disconnect and de-energize all equipment & circuits. **NEVER!** work on live or energized circuits or equipment.

**Use & Care Guide For Insulated Tools:**

Store tools to minimize risk of damage to insulation  
 Inspect insulation prior to each use of any insulated tool  
 If you doubt the integrity of the insulation destroy the tool or have it retested  
 Use insulated tools where the ambient temperature is between -20 to +70° C  
 Have a qualified safety technician inspect and re-certify tools annually for safe use



1000Volt

**322 91** Set 5 Pcs. Nut Driver Metric Sizes

Item No.	mm	mm	mm	mm	mm	lbs.	
322 91	322 15	6.0	125	322 24	9.0	125	1.36
	322 18	7.0	125	322 27	10.0	125	Each
	322 21	8.0	125				\$48.76



1000Volt

**322 93** Set 7 Pcs. Nut Driver Metric Sizes

Item No.	mm	Inch	mm	Inch	lbs.		
322 93	322 09	5.0	125	322 21	8.0	125	2.05
	322 12	5.5	125	322 27	10.0	125	Each
	322 15	6.0	125	322 36	13.0	125	\$66.98
	322 18	7.0	125				



1000Volt

**322 92** Set 5 Pcs. Nut Driver Inch Sizes

Item No.	Inch	Inch	Inch	Inch	lbs.		
322 92	322 61	7/32	5.0	322 70	3/8	5.0	1.52
	322 64	1/4	5.0	322 76	1/2	5.0	Each
	322 67	5/16	5.0				\$48.66



1000Volt

**322 94** Set 7 Pcs. Nut Driver Inch Sizes

Item No.	Inch	Inch	Inch	Inch	lbs.		
322 94	322 58	3/16	5.0	322 70	3/8	5.0	2.24
	322 61	7/32	5.0	322 73	7/16	5.0	Each
	322 64	1/4	5.0	322 76	1/2	5.0	\$69.98
	322 67	5/16	5.0				



Made in Germany

Toll Free: (800) 494-6104

Wiha Insulated TORX® Screwdrivers



**325 TORX®** Screwdriver, With Wiha-SoftFinish® Handle  
 Insulation According to ASTM F-1505-01, New VDE Specification  
 0682/part 201 and IEC 900, up to 1000 Volt. "GS" Sign.  
 Individually Tested. Blade high alloy cvm steel, hardened, black  
 finish. Insulation molded directly onto blade.

Item No.	Size	mm	Inch	mm	Inch	lbs.	pkg.	Each
325 05	T5	60	2.4	164	6.5	.06	10	\$4.80
325 11	T6	60	2.4	164	6.5	.06	10	\$4.80
325 16	T7	60	2.4	164	6.5	.06	10	\$4.80
325 21	T8	60	2.4	164	6.5	.06	10	\$4.80
325 26	T9	60	2.4	164	6.5	.06	10	\$4.80
325 31	T10	60	2.4	164	6.5	.06	10	\$4.80
325 36	T15	80	3.0	191	7.5	.12	10	\$5.90
325 41	T20	80	3.0	191	7.5	.12	10	\$5.90
325 46	T25	80	3.0	198	7.8	.17	10	\$5.90
325 51	T27	100	4.0	218	8.6	.20	10	\$7.60
325 56	T30	100	4.0	218	8.6	.20	10	\$7.60
325 61	T40	150	6.0	274	10.8	.30	10	\$10.70
325 66	T45	150	6.0	274	10.8	.35	10	\$11.20

Wiha Insulated Pliers - Comfort Grip Handle



**328 96** 31 Pc. Pliers & Screwdriver Set. Insulation According to VDE  
 0682/part 201, DIN EN 60900, IEC 900, ASTM F-1505-01, up to 1000  
 volt. "GS" Sign. Individually Tested. Pliers drop-forged from special  
 tool steel, individually high frequency induction hardened, chrome/nickel  
 plated, mirror-polished. Set includes 6ft. Fiber glass folding ruler.

**328 96** 31 Pc. Master Electricians Insulated Set

Item# **32896** Set Includes: lbs. 12.75 Each \$488.98

32806 - 6.5" Long Nose Pliers	32832 - 6.5" Side Cutter
32808 - 8" Long Nose	32838 - 8" High Leverage Cutter
32816 - 7" Linemans	32860 - 6.5" Stripping Pliers
32820 - 9" Combination Pliers	32870 - 6.5" Round Nose Pliers
32255 - Ins Nut Driver 5/32"	32005 - Insulated Slotted 2.0
32258 - Ins Nut Driver 3/16"	32010 - Insulated Slotted 2.5
32261 - Ins Nut Driver 7/32"	32012 - Insulated Slotted 3.0
32264 - Ins Nut Driver 1/4"	32015 - Insulated Slotted 3.5
32267 - Ins Nut Driver 5/16"	32024 - Insulated Slotted 4.0
32270 - Ins Nut Driver 3/8"	32026 - Insulated Slotted 5.5
32273 - Ins Nut Driver 7/16"	32039 - Insulated Slotted 6.5
32276 - Ins Nut Driver 1/2"	32042 - Insulated Slotted 8.0
32278 - Ins Nut Drivers 9/16"	32045 - Insulated Slotted 10.0
32100 - Insulated Phillips #0	32102 - Insulated Phillips #2
32101 - Insulated Phillips #1	32103 - Insulated Phillips #3



**325 90** Set 6 Pcs. TORX®

Item No.	Size	mm	Inch	mm	Inch	lbs.	pkg.	Each
325 90	325 21	T8	60	325 36	T15	80		.83
	325 26	T9	60	325 41	T20	80		Each
	325 31	T10	60	325 46	T25	80		\$32.12



**326 50** Retaining Ring Bit Holding Screwdriver, With Wiha-SoftFinish® Handle  
 Insulation According to ASTM F-1505-01, New VDE Specification 0682/part 201 and IEC 900,  
 up to 1000 Volt. "GS" Sign. Individually Tested. Blade high alloy CVM steel,  
 hardened, black finish. Insulation molded directly onto blade.  
 Wiha-SoftFinish® handle, multi-component. Holds 1/4" drive bits.

Item No.	Size	mm	Inch	mm	Inch	lbs.	pkg.	Each
326 50	1/4"	60	2.4	164	6.5	.06	10	\$11.98



**380 25** Magnetic Bit Holder, 1/4", Wiha-Powerhandle, Insulated,  
 cellulose-acetate, impact resistant. Snap-lock rotatable cap. Chambered  
 bit holder equipped with transparent selector for easy selection of bits.  
 1/4" bit holder, shielded, magnetic, holds bit and screw.  
 Cavity holds up to 6 bits. (bits not included)

Item No.	Size	mm	Inch	mm	Inch	lbs.	pkg.	Each
380 25	1/4	120	4.7	230	9.0	.26	1	\$13.18

Insulation meets VDE, ASTM & IEC specifications

See Additional Bit Holders  
 On Page 154



Made in Germany

www.wihatools.com

Wiha Insulated Pliers with High Visibility Comfort Grip Handle



⚡ 1000Volt

**328 91 10 Pc. Plier & Screwdriver Set.** Insulation According to VDE 0682/part 201, DIN EN 60900, IEC 900, ASTM F-1505-01, ⚡ up to 1000 volt. "GS" Sign. Individually Tested. Pliers drop-forged from special tool steel, individually high frequency induction hardened, chrome and nickel plated, mirror-polished. In zipper carry case.

<b>Item# 32891</b> Set Includes:	wt. 5.44	<b>Each \$277.00</b>
32818 - 8" Combination Pliers	32808 - 8" Long Nose	
32838 - 8" Side Cutter	32848 - 6.75" Cable Cutters	
32860 - 6.5" Universal Wire Stripper		
32101 - Insulated Phillips #1	32024 - Insulated Slotted 4.5	
32102 - Insulated Phillips #2	32039 - Insulated Slotted 6.5	
32103 - Insulated Phillips #3		



⚡ 1000Volt

**328 92 10 Pc. Plier & Screwdriver Set.** Insulation According to VDE 0682/part 201, DIN EN 60900, IEC 900, ASTM F-1505-01, ⚡ up to 1000 volt. "GS" Sign. Individually Tested. Pliers drop-forged from special tool steel, individually high frequency induction hardened, chrome and nickel plated, mirror-polished. In molded tool box.

<b>Item# 32892</b> Set Includes:	wt. 6.64	<b>Each \$185.98</b>
32804 - 8" Bent Nose	32818 - 8" Combination Pliers	
32806 - 6.5" Long Nose	32832 - 6.5" Side Cutter	
32100 - Insulated Phillips #0	32012 - Insulated Slotted 3.0	
32101 - Insulated Phillips #1	32024 - Insulated Slotted 4.5	
32102 - Insulated Phillips #2	32039 - Insulated Slotted 6.5	



⚡ 1000Volt

**328 95 14 Pc. Plier & Screwdriver Set.** Insulation According to VDE 0682/part 201, DIN EN 60900, IEC 900, ASTM F-1505-01, ⚡ up to 1000 volt. "GS" Sign. Individually Tested. Pliers drop-forged from special tool steel, individually high frequency induction hardened, chrome and nickel plated, mirror-polished. In zipper carry case.

<b>Item# 32895</b> Set Includes:	wt. 6.50	<b>Each \$278.98</b>
32808 - 8" Long Nose	32832 - 6.5" Side Cutter	
32820 - 9" Combination Plier	32838 - 8" High Leverage Cutter	
32860 - 6.5" Stripping Plier	32010 - Insulated Slotted 2.5	
32101 - Insulated Phillips #1	32012 - Insulated Slotted 3.0	
32102 - Insulated Phillips #2	32015 - Insulated Slotted 3.5	
32103 - Insulated Phillips #3	32024 - Insulated Slotted 4.5	
32005 - Insulated Slotted 2.0	32039 - Insulated Slotted 6.5	



**328 94 12 Pc. Plier & Screwdriver Set.** In molded tool box.

<b>Item# 32894</b> Set Includes:	wt. 7.73	<b>Each \$214.98</b>
32804 - 8" Bent Nose	32818 - 8" Combination Pliers	
32806 - 6.5" Long Nose	32832 - 6.5" Side Cutter	
32024 - Insulated Slotted 4.5	32264 - Ins Nut Driver 1/4"	
32039 - Insulated Slotted 6.5	32267 - Ins Nut Driver 5/16"	
32101 - Insulated Phillips #1	32270 - Ins Nut Driver 3/8"	
32102 - Insulated Phillips #2	32276 - Ins Nut Driver 1/2"	



Made in Germany

Toll Free: (800) 494-6104

**Wiha Pliers & Cutters Index**

	Description	Page
	Insulated Combination Pliers	88
	Insulated Diagonal Cutters Heavy Duty	89
	Insulated Diagonal Cutters High Leverage	89
	Insulated Cable Cutter	89
	Insulated Bent Nose Pliers	90
	Insulated Long Nose Pliers	90
	Insulated Round Nose Plier	91
	Insulated Stripping Plier	91
	Insulated Tool Sets	85-86
<b>COMFORTGRIP PLIERS/CUTTERS</b>		
	Combination Pliers	92
	Stripping Pliers	92
	Long Nose Pliers	93
	Bent Long Nose Pliers	93
	Flat Nose Pliers	93
	Adjustable Pliers	94
	Diagonal Cutters	95
	ComfortGrip Tool Sets	95
<b>STANDARD GRIP PLIERS/CUTTERS</b>		
	Combination Pliers	96
	Stripping Pliers	96
	Long Nose Pliers	97
	Bent Long Nose Pliers	97
	Long Flat Nose Pliers	97
	Long Round Nose Pliers	97
	Adjustable Pliers	98
	High Leverage Cable Cutters	99
	Diagonal Cutters	99

	High Leverage End Cutting Pliers	99
	Carpenter's End Nippers	100
	Mason Nippers	100
	Retaining Ring Pliers	101
	Wiha Standard Plier/Cutter Sets	98
<b>ESD SAFE PLIERS/CUTTERS</b>		
	ESD Safe Diagonal Cutters Small Tapered Head	104
	ESD Safe Diagonal Cutters Wide Tapered Head	105
	ESD Safe Diagonal Cutters Oval Heads	105-106
	ESD Safe Diagonal Cutters With Carbide Cutters	106
	ESD Safe Oblique Angled Cutters	107
	ESD Safe Oblique Front Cutters	107
	ESD Safe End Cutters	108
	ESD Safe Snipe/Bent Nose Pliers	108
	ESD Safe Needle Nose Pliers	109
	ESD Safe Short Round Nose	109
	ESD Safe Short Flat Nose	109
	ESD Safe Tool Sets	109

**Wiha Maxiflex Rulers Index**

	Description	Page
	Inch/Metric Rulers	102



Made in Germany

www.wihatools.com

**Wiha Insulated Pliers & Cutters**

**Insulation Standards:**

DIN EN 60900, IEC 900, ASTM F-1505-01, and or According to VDE 0682/part 201.

**1000V**

Cutters additionally induction hardened

**NEW**  
from Wiha

Chrome finish for long lasting corrosion protection

Soft grip ergonomically designed handle body

Safety slip guard

Two Component Anti-slip handle material for a comfortable and safe grip

**Tools Meet 10,000 Volt test Standards Certified to 1000 Volt ac or 1500 Volt dc.**

**Insulated Combination Lineman's Pliers**



1000volt

**328** Combination Pliers. Insulation According to VDE 0682/part 201, DIN EN 60900, IEC 900, ASTM F-1505-01, up to 1000 volt. "GS" Sign. Individually Tested. DIN ISO 5746 Extra long cutting edge for flat & round cables. Serrated jaws. Cutting edges additionally induction hardened to approx. 60HRC. Special CV tool steel forgings, Chrome finish. Use For gripping and holding as well as cutting soft and hard wires and cables. Two component Soft grip ergonomic handles.

Item No.		↔	↔	Cutting Capacity	🔋	🔌	Each
		mm	Inch	Copper AWG	Pkg.	wt.	
<b>328 14</b>	Z01016006	160	6.5	#10	1	.53	<b>\$28.98</b>
<b>328 16</b>	Z01018006	180	7.0	#9	1	.58	<b>\$34.98</b>
<b>328 18</b>	Z01020006	200	8.0	#8	1	.72	<b>\$38.98</b>

**Insulated High Leverage Combination Pliers**

Lineman's



1000volt

With Lower Serrated Pulling Jaws

**328** High Leverage Combination Pliers. Insulation According to DIN EN 60900, IEC 900, ASTM F-1505-01, up to 1000 volt. "GS" Sign. Individually Tested. DIN ISO 5746

Extra long cutting edge for flat and round cables. Serrated upper jaws and lower pulling jaws. Cutting edges additionally induction hardened to approx. 64HRC. C 60 Special tool steel. Use For gripping, pulling & holding as well as cutting wires and cables ranging in hardness from soft to extremely hard. Two component Soft grip ergonomic handles.

Item No.		↔	↔	Cutting Capacity	🔋	🔌	Each
		mm	Inch	Copper AWG	Pkg.	wt.	
<b>328 20</b>	Z02022506	225	9.0	#4	1	.79	<b>\$39.98</b>

**Warning!** Insulated tools are not intended for use on live or energized circuits. Always disconnect and de-energize all equipment & circuits. **NEVER!** work on live or energized circuits or equipment.

**Use & Care Guide For Insulated Tools:**

- Store tools to minimize risk of damage to insulation
- Inspect insulation prior to each use of any insulated tool
- If you doubt the integrity of the insulation destroy the tool or have it retested
- Use insulated tools where the ambient temperature is between -20 to +70° C
- Have a qualified safety technician inspect and re-certify tools annually for safe use





Made in Germany

Toll Free: (800) 494-6104

**Wiha Insulated Pliers & Cutters**

**Insulated Diagonal Cutters**



**328 Diagonal Cutters.** Insulation According to VDE 0682/part 201, DIN EN 60900, IEC 900, ASTM F-1505-01, ⚡ up to 1000 volt. "GS" Sign. Individually Tested. DIN ISO 5749 Low wear lap joint, riveted and able to withstand high levels of load. Lightweight action, clean cutting. Long term cutting is achieved through additional inductive hardening to approx. 60 HRC. Special tool steel hardened and tempered. For soft & medium hard wire. 32832 & 32834 for soft, hard & piano wire.

Item No.		↔	↔	Cutting Capacity		📦	⚖️	👤
		mm	Inch	Copper	AWG	Pkg.	wt.	Each
328 30	Z12014006	140	5.5	#6		1	.47	\$28.98
328 32	Z12016006	160	6.5	#6		1	.49	\$35.98
328 34	Z12018006	180	7.0	#6		1	.62	\$39.98

**Insulated High Leverage Diagonal Cutters**



**328 High Leverage Diagonal Cutters.** Insulation According to VDE 0682/part 201, DIN EN 60900, IEC 900, ASTM F-1505-01, ⚡ up to 1000 volt. "GS" Sign. Individually Tested. DIN ISO 5749 Semi-circular. Low wear lap joint, riveted and able to withstand high levels of load. Lightweight action, clean cutting. Long term cutting is achieved through additional inductive hardening to approx. 64 HRC. C 60 special tool steel hardened and tempered to high quality. For soft, hard and piano wire, lay-on joint, optimized power transmission.

Item No.		↔	↔	Cutting Capacity		📦	⚖️	👤
		mm	Inch	Copper	AWG	Pkg.	wt.	Each
328 35	Z16016006	160	6.5	#6		1	.54	\$36.98
328 36	Z16018006	180	7.0	#5		1	.57	\$45.98
328 38	Z16020006	200	8.0	#4		1	.64	\$48.98

**Insulated Cable Cutter**



**328 Cable Cutter.** Insulation According to VDE 0682/part 201, DIN EN 60900, IEC 900, ASTM F-1505-01, ⚡ up to 1000 volt. "GS" Sign. Individually Tested. Drop-forged from durable CV steel, cutters additionally induction hardened, chrome & nickel plated, Mirror-polished. For copper and aluminum cables (not for steel wires), integrated release spring, one-hand locking, adjustable joint, anti-squeeze feature.

Item No.		↔	↔	Min	Max	📦	⚖️	👤
		mm	Inch	mm	mm	Pkg.	wt.	Each
328 46	Z50023006	230	9.0	17	40	1	.98	\$59.98
328 48	Z50017006	170	6.75	10	60	1	.67	\$49.98





Made in Germany

www.wihatools.com

Wiha Insulated Pliers & Cutters

Insulated Long Nose Pliers

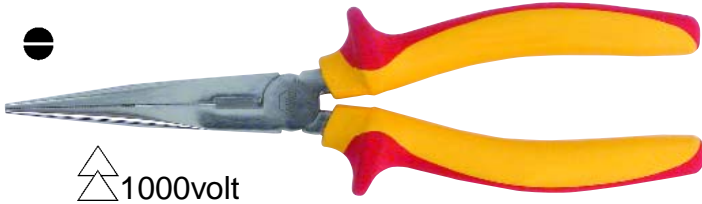

**328 Long Nose Pliers With Cutter. Insulation According to VDE 0682/part 201, DIN EN 60900, IEC 900, ASTM F-1505-01, up to 1000 volt. "GS" Sign. Individually Tested.** Drop-forged from special tool steel, cutters additionally induction hardened (approx. 60 HRC), chrome-nickel plated, mirror-polished, ergonomic comfort grip with slip guard, half-round jaws, serrated gripping surface.

Item No.		↔ mm	↔ Inch	Cutting Capacity Copper AWG	🔌 Pkg.	📏 wt.	💰 Each
328 06	Z05016006	160	6.5	#10	1	.32	\$31.98
328 08	Z05020006	200	8.0	#8	1	.42	\$34.98

Insulated Bent Nose Pliers

Angled approx. 40°

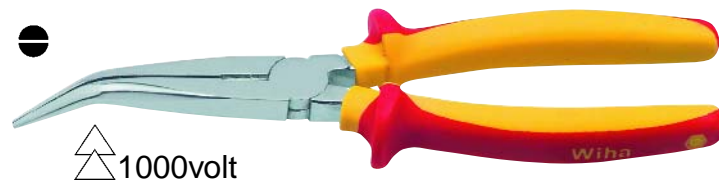

**328 Bent Nose Pliers With Cutter. Insulation According to VDE 0682/part 201, DIN EN 60900, IEC 900, ASTM F-1505-01, up to 1000 volt. "GS" Sign. Individually Tested.**

Drop-forged from special tool steel, cutters additionally induction hardened (approx. 60 HRC), chrome-nickel plated, mirror-polished. Ergonomic comfort grip with slip guard. Half-round jaws, serrated gripping surface, nose bent 45°.

Item No.		↔ mm	↔ Inch	Cutting Capacity Copper AWG	🔌 Pkg.	📏 wt.	💰 Each
328 04	Z05120006	200	8.0	#8	1	.43	\$39.98
328 07	Z05116006	160	6.5	#10	1	.32	\$32.98

1000 Volt Rated

**Warning!** Insulated tools are not intended for use on live or energized circuits. Always disconnect and de-energize all equipment & circuits. **NEVER!** work on live or energized circuits or equipment.

**Use & Care Guide For Insulated Tools:**

- Store tools to minimize risk of damage to insulation
- Inspect insulation prior to each use of any insulated tool
- If you doubt the integrity of the insulation destroy the tool or have it retested
- Use insulated tools where the ambient temperature is between -20 to +70° C
- Have a qualified safety technician inspect and re-certify tools annually for safe use

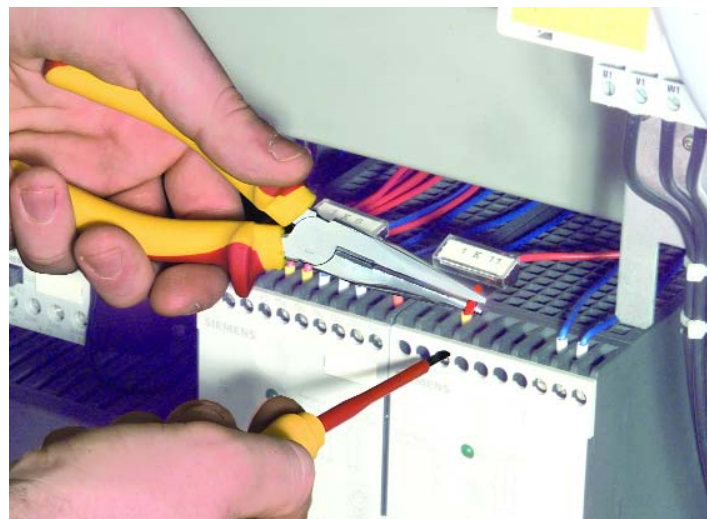



Made in Germany

Toll Free: (800) 494-6104

**Wiha Insulated Pliers & Cutters**

**Round Nose Pliers**

1000volt



**328 Round Nose Pliers.** Insulation According to VDE 0682/part 201, DIN EN 60900, IEC 900, ASTM F-1505-01, up to 1000 volt. "GS" Sign. Individually Tested. Drop-forged from special tool steel, individually induction hardened, chrome and nickel plated, mirror-polished. Ergonomic comfort grip with slip guard. Serrated jaws.

Item					
No.	mm	Inch	Pkg.	wt.	Each
328 70	Z09016006	160	6.5	1	.31 \$30.98

**Insulated Long Flat Nose Pliers**



1000volt

**328 Long Flat Nose Pliers.** Insulation According to VDE 0682/part 201, DIN EN 60900, IEC 900, ASTM F-1505-01, up to 1000 volt. "GS" Sign. Individually Tested. DIN ISO 5745 Extra long head. Serrated Jaws are induction hardened. Special CV tool steel forgings, Chrome finish. Two component Soft Grip handles. Use for Gripping and right-angle bending of wires and sheet metal parts.

Item					
No.	mm	Inch	Pkg.	wt.	Each
328 10	Z07016006	160	6.5	1	.39 \$29.98

**Insulated Stripping Pliers**

1000volt



**328 Stripping Pliers.** Insulation According to VDE 0682/part 201, DIN EN 60900, IEC 900, ASTM F-1505-01, up to 1000 volt. "GS" Sign. Individually Tested. Drop-forged from special tool steel, individually high frequency induction hardened, chrome and nickel plated, mirror-polished. Ergonomic comfort grip with slip guard. Spring and adjusting screw, for wires up to Ø 5mm

Item			Stripping Capacity			
No.	mm	Inch	Copper AWG	Pkg.	wt.	Each
328 60	Z55016006	160	6.5 #4 - #28	1	.36 \$38.98	



**Warning!**  
Insulated tools are not intended for use on live or energized circuits. Always disconnect and de-energize all equipment & circuits. **NEVER!** work on live or energized circuits or equipment.



Made in Germany

www.wihatools.com

**Wiha ComfortGrip Pliers & Cutters**

Maximum comfort in daily use, smooth operation & optimum force transmission without uncomfortable pressure points. A multi-layered chrome finish provides the highest level of corrosion protection.

**NEW**  
from Wiha

Hard Chrome finish for long lasting corrosion protection.



Ergonomic shape for maximum user comfort

Cutters additionally induction hardened

Soft rounded slip guard molded into grip

Anti-slip soft dual material Handles for safe gripping

**ComfortGrip Combination Pliers**



**329 10 Combination Pliers DIN ISO 5746**

Extra long cutting edge for flat and round cables. Serrated jaws. Cutting edges additionally induction hardened to approx. 60HRC. Special CV tool steel. For gripping and holding as well as cutting soft and hard wires and cables. Two component ComfortGrip ergonomic handles

Item	↔	↔	Cutting Capacity		☐	↕
No.	mm	Inch	Copper AWG	Pkg. wt.	Each	
329 10 Z01020005	200	8.0	#8	1	.72	\$25.98

**ComfortGrip Heavy Duty Combination Pliers**



**329 16 Heavy Duty Combination Pliers DIN ISO 5746**

Larger Head and extra long cutting edges for flat and round cables. Serrated jaws with lower fish tape pulling jaw. Cutting edges additionally induction hardened to approx. 64HRC. Special CV tool steel. For gripping & holding as well as cutting wires & cables ranging in hardness from soft to extremely hard. Two component ComfortGrip ergo handles.

Item	↔	↔	Cutting Capacity		☐	↕
No.	mm	Inch	Copper AWG	Pkg. wt.	Each	
329 16 Z02022505	225	9.0	#5	1	.79	\$33.98

**ComfortGrip Stripping Pliers**



**329 46 Stripping Pliers DIN ISO 5744**

Precision cutting edge formed for even cutting of cable insulation. Easy to use adjustment screw allows stripping diameter to be quickly changed. Return spring for effortless use. Special CV tool steel edges, individually induction hardened. Stripping Diameter: .019" to .393" Ø.5mm - 10mm.

Item	↔	↔	Stripping Capacity		☐	↕
No.	mm	Inch	Copper AWG	Pkg. wt.	Each	
329 46 Z55016005	160	6.5	#4 - #28	1	.31	\$27.98



Made in Germany

Toll Free: (800) 494-6104

**Wiha ComfortGrip Pliers**

**ComfortGrip Long Nose Pliers**



**329 Long Nose Pliers With Cutting Edge DIN ISO 5745**  
 Long nose pliers. Extra long cutters for flat and round wires. Gripping surfaces serrated in parts. Cutting edges additionally induction hardened to approx. 60 HRC. Special tool steel. Two component ComfortGrip handle.

Item No.	mm	Inch	Cutting Capacity Copper AWG	Pkg.	wt.	Each
329 19 Z05016005	160	6.5	#8	1	.32	\$22.98
329 22 Z05020005	200	8.0	#8	1	.42	\$29.98

**ComfortGrip Bent Long Nose Pliers**

Angled approx. 40°



**329 24 Bent Nose Pliers With Cutters DIN ISO 5745**  
 Long nose pliers angled approx. 40°. Extra long cutting edge for flat and round wires. Gripping surfaces serrated in parts. Cutting edges additionally induction hardened to approx. 60 HRC. Special tool steel. Two component ComfortGrip handle.

Item No.	mm	Inch	Cutting Capacity Copper AWG	Pkg.	wt.	Each
329 24 Z05116005	160	6.5	#8	1	.32	\$27.98

**ComfortGrip Flat Nose Pliers**



**329 31 Long Flat Nose Pliers DIN ISO 5745**  
 Extra long head. Gripping surfaces serrated and induction hardened. Special tool steel. Two component ComfortGrip handle. Gripping and right-angled bending of wires and sheet metal parts.

Item No.	mm	Inch	Cutting Capacity Copper AWG	Pkg.	wt.	Each
329 31 Z07016005	160	6.5	#8	1	.32	\$25.98

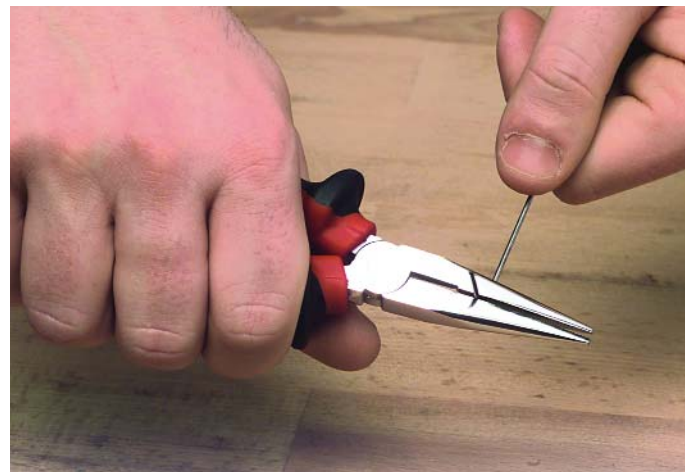





Made in Germany

Toll Free: (800) 494-6104

**Wiha Professional ComfortGrip Pliers/Cutters**

**ComfortGrip Diagonal Cutters**



**329 Diagonal Cutters DIN ISO 5749**

Low wear lap joint, riveted and able to withstand high levels of load. Low force action, clean cutting. Long life cutting edge is achieved with additional induction hardening to approx. 60 HRC. Special CV tool steel forgings hardened and tempered. For soft & medium hard wire.

Item No.		↔	↔	Cutting Capacity Copper AWG	Pkg.	wt.	Each
		mm	Inch				
329 36	Z12014005	140	5.5	#6	1	.39	\$25.98
329 40	Z12016005	160	6.5	#6	1	.48	\$26.98
329 43	Z12018005	180	7.0	#6	1	.62	\$28.98

**ComfortGrip High Leverage Diagonal Cutters**



**329 High Leverage Diagonal Cutters DIN ISO 5749**

Semi-circular. Low wear lap joint, riveted and able to withstand high levels of load. Low force action, clean cutting. Long life cutting edges are achieved through additional induction hardening to approx. 64 HRC. C60 special CV tool steel hardened and tempered.

Item No.		↔	↔	Cutting Capacity Copper AWG	Pkg.	wt.	Each
		mm	Inch				
329 50	Z16018005	180	7.0	#5	1	.57	\$35.98
329 53	Z16020005	200	8.0	#4	1	.64	\$37.98



**329 90 4 Pc. Comfort Grip Plier Set In Zipper Case**

Low wear lap joint, riveted and able to withstand high levels of load. Low force action, clean cutting. Long life cutting edge is achieved with additional induction hardening to approx. 60 HRC. Special CV tool steel forgings hardened and tempered.

Item#	32990 Set Includes:	Each
32910	Combo Pliers - 8"	\$126.98
32946	Wire Stripper - 6.5"	
32919	Long Nose Pliers - 6.5"	\$126.98
32940	Side Cutter - 6.5"	



**329 91 18 Pc. Comfort Grip Plier/Driver/Wrench Set In Zipper Case**

Low force action, clean cutting. Special CV tool steel forgings hardened and tempered. SoftFinish cushion grip screwdriver handle, allows maximum torque and user comfort. Open End wrenches precision formed for exact fit. Satin chromed sure grip body.

Item#	32991 Set Includes:	Each
32910	Combo Pliers - 8"	\$229.98
32940	Side Cutter - 6.5"	
32919	Long Nose Pliers - 6.5"	\$229.98
32962	Adjustable Pliers - 10"	
36276	SoftFinish Torx T15	\$229.98
30215	SoftFinish Slotted 4.0	
36278	SoftFinish Torx T20	\$229.98
30223	SoftFinish Slotted 6.5	
36280	SoftFinish Torx T25	\$229.98
31110	SoftFinish Phillips #1	
36282	SoftFinish Torx T27	\$229.98
31115	SoftFinish Phillips #2	
36284	SoftFinish Torx T30	\$229.98
35032	Open End 1/4" x 5/16"	
35034	Open End 3/8" x 7/16"	\$229.98
35039	Open End 5/8" x 11/16"	
35036	Open End 1/2" x 9/16"	\$229.98
35043	Open End 7/8" x 3/4"	



Made in Germany

www.wihatools.com

**Wiha Vinyl Grip Pliers & Cutters**

Wiha Pliers & Cutters, Professional quality at competitive prices. A wide selection covering most applications in which pliers & cutters are required.

**NEW**  
from Wiha

Precision formed

Jaws & Cutters induction hardened

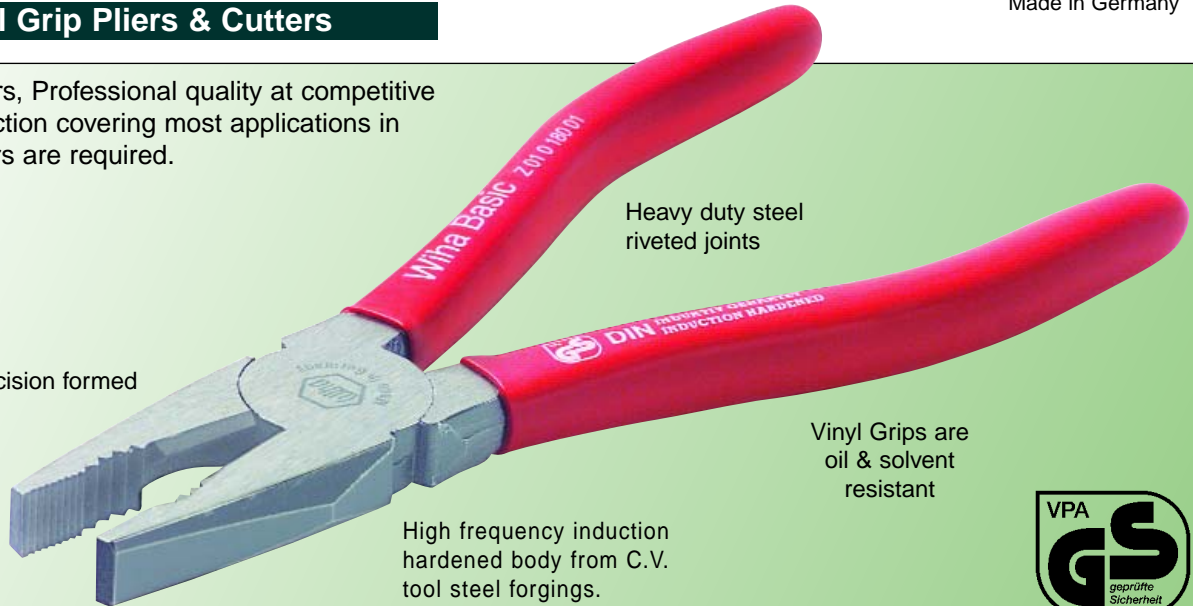

Heavy duty steel riveted joints

High frequency induction hardened body from C.V. tool steel forgings.

Vinyl Grips are oil & solvent resistant



**Combination Pliers**



**326 Combination Pliers DIN ISO 5746**

Extra long cutting edge for flat and round cables. Serrated jaws. Cutting edges additionally induction hardened to approx. 60HRC. C.V. Special tool steel. For gripping and holding as well as cutting soft and hard wires and cables. Soft vinyl grips, oil & solvent resistant.

Item No.		↔	↔	Cutting Capacity	↔	↔
		mm	Inch	Copper AWG	Pkg.	wt. Each
326 03	Z01016001	160	6.5	#10	1	.41 \$15.98
326 06	Z01018001	180	7.0	#9	1	.50 \$16.98
326 09	Z01020001	200	8.0	#8	1	.63 \$18.98

**High Leverage Combination Pliers**



With Lower Serrated Pulling Jaws

**326 High Leverage Heavy Duty Combination Pliers DIN ISO 5746**

Extra long cutting edge for flat and round cables. Serrated upper jaws and lower pulling jaws. Cutting edges additionally induction hardened to approx. 60HRC. C.V. Special tool steel forgings. Use For gripping, pulling & holding as well as cutting soft, hard & piano wires and cables. Soft vinyl grips are oil & solvent resistant.

Item No.		↔	↔	Cutting Capacity	↔	↔
		mm	Inch	Copper AWG	Pkg.	wt. Each
326 12	Z02020001	200	8.0	#4	1	.61 \$21.98
326 15	Z02022501	225	9.0	#4	1	.78 \$24.98

**Stripping Pliers**



**326 45 Stripping Pliers DIN ISO 5744**

Precision cutting edge prism for even cutting of cable insulation. Easy to use adjusting screw allows the stripping diameter to be set. Opening spring for effortless and sensitive handling of pliers. C.V. special tool steel, individually induction hardened. Stripping of cables and strands up to Ø 5mm = 10mm<sup>2</sup> conductor cross-section. Soft vinyl grips.

Item No.		↔	↔	Stripping Capacity	↔	↔
		mm	Inch	Copper Awg#	Pkg.	wt. Each
326 45	Z55016001	160	6.5	#4 - #28	1	.31 \$21.98





Made in Germany

Toll Free: (800) 494-6104

**Wiha Vinyl Grip Pliers & Cutters**

**Long Nose Pliers**



**326 Long Nose Pliers With Cutters DIN ISO 5745**

Long nose pliers. Extra long cutters for flat and round cables. Serrated Jaws. Cutting edges additionally induction hardened to approx. 60 HRC. Special CV tool steel forgings. Soft vinyl grips are oil & solvent resistant.

Item No.	mm	Inch	Cutting Capacity Copper AWG	Pkg. wt.	Each
326 18 Z05016001	160	6.5	#10	1 .28	\$18.98
326 21 Z05020001	200	8.0	#8	1 .36	\$24.98

**Bent Long Nose Pliers**

Angled approx. 40°



**326 Bent Long Nose Pliers With Cutters DIN ISO 5745**

Long nose pliers angled approx. 40°. Extra long cutters for flat and round wire. Partially Serrated Jaws. Cutting edges additionally induction hardened to approx. 60 HRC. Special CV tool steel forgings. Soft vinyl grips are oil & solvent resistant.

Item No.	mm	Inch	Cutting Capacity Copper AWG	Pkg. wt.	Each
326 23 Z05116001	160	6.5	#10	1 .28	\$21.98
326 25 Z05120001	200	8.0	#8	1 .36	\$27.98

**Long Flat Nose Pliers**



**326 30 Long Flat Nose Pliers DIN ISO 5745**

Extra long head. Serrated Jaws are induction hardened. Special CV tool steel forgings. Use for gripping and right-angled bending of wires and sheet metal parts. Soft vinyl grips are oil & solvent resistant.

Item No.	mm	Inch	Pkg. wt.	Each
326 30 Z07016001	160	6.5	1 .26	\$19.98

**Long Round Nose Pliers**



**326 33 Long Round Nose Pliers DIN ISO 5745**

Extra long head. Serrated Jaws are induction hardened. Special CV tool steel forgings. Use for gripping and uniform round bending of wires and sheet metal parts. Soft vinyl grips are oil & solvent resistant.

Item No.	mm	Inch	Pkg. wt.	Each
326 33 Z09016001	160	6.5	1 .25	\$18.98





Made in Germany

www.wihatools.com

Wiha Vinyl Grip Pliers & Cutters

Standard Adjustable Pliers



326 Adjustable Pliers - Box Type DIN ISO 5745

10 different opening sizes provide optimal adjustment to objects being gripped. Long durability achieved through additional induction hardening of jaws to approx. 58-60 HRC. Chrome-vanadium tool steel, hardened and tempered. Soft vinyl grips are oil and solvent resistant.

Item No.		↔		↔↔		Capacities	Pkg.	wt.	Each
		mm	Inch	Round	Hex				
326 60	Z21018001	180	7.0	1.25	1 1/2	1	.35	\$21.98	
326 61	Z21025001	250	10.0	1.75	2"	1	.67	\$22.98	
326 63	Z21030001	300	12.0	2.0	2 1/4	1	1.21	\$33.98	

Slide Lock Adjustable Pliers - "QuickFix"



- Open and slide to adjust opening size
- Close to lock
- Audible click at each locking position

326 68 Slide Lock Adjustable Pliers - Wiha QuickFix - Box Type

DIN ISO 8976 Super fast and easily adjusted pliers. Long durability achieved through additional induction hardening of jaws to approx. 56 HRC. Finger jam protection for safe operation in all settings. Chrome-vanadium tool steel, hardened and tempered. Soft vinyl grips.

Item No.		↔		↔↔		Capacities	Pkg.	wt.	Each
		mm	Inch	Round	Hex				
326 68	Z23025001	250	10.0	1 1/4	1 1/2	1	.72	\$31.98	



326 01 4 Pc. Pliers & Cutters Set

Drop-forged from special tool steel, individually high frequency induction hardened. Precision formed. Soft vinyl grips, oil & solvent resistant. In zipper carry case.

Item# 32601	Set Includes:	↔↔ wt. 3.45	Each \$99.98
32609	- Combination Pliers	32661	- Water Pump Pliers
32618	- Long Nose Pliers	32642	- Diagonal Cutters



326 98 3 Pc. Pliers & Cutters Set

Drop-forged from special tool steel, individually high frequency induction hardened. Precision formed. Soft vinyl grips, oil & solvent resistant.

Item# 32698	Set Includes:	↔↔ wt. 1.36	Each \$55.48
32606	- Combination Pliers	32642	- Diagonal Cutters
32618	- Long Nose Pliers		



Made in Germany

Toll Free: (800) 494-6104

Wiha Vinyl Grip Pliers & Cutters

High Leverage Cable Cutters



326 High Leverage Cable Cutters

Sickle-shaped cutting edge to prevent cable movement when cutting. Fastened adjustable lay-on joint. Clean cutting edges for cutting soft cable. Safety lock with opening spring. Special CV tool steel forging, hardened and tempered for maximum performance. Soft vinyl grips are oil & solvent resistant.

Item		↔	↔	Min.	Max.	🔒	🔓	
No.		mm	Inch	mm	mm	Pkg.	wt.	Each
32641	Z50017001	170	6.75	12	40	1	.62	\$30.98
32643	Z50023001	230	9	18	60	1	.94	\$49.98

Diagonal Cutters



326 Diagonal Cutters DIN ISO 5749

Low wear lap joint, riveted and able to withstand high levels of load. Low force cutting action, clean cutting. Long life edge is achieved through additional induction hardening to approx. 60 HRC. Special CV tool steel hardened and tempered. For soft & medium hard wire. Soft vinyl grips.

Item		↔	↔	Cutting Capacity	🔒	🔓	
No.		mm	Inch	Copper AWG	Pkg.	wt.	Each
326 38	Z12014001	140	5.5	#6	1	.33	\$18.98
326 42	Z12016001	160	6.5	#6	1	.42	\$19.98
326 39	Z12018001	180	7.0	#6	1	.53	\$21.98

High Leverage Cutters



326 High Leverage Cutters DIN ISO 5749

Semi-circular. Low wear lap joint, riveted and able to withstand high levels of load. Low force action, clean cutting. Long life is achieved through additional induction hardening of cutting edge to 64 HRC.

CV 60 special tool steel hardened and tempered. Soft vinyl grips

Item		↔	↔	Cutting Capacity	🔒	🔓	
No.		mm	Inch	Copper AWG	Pkg.	wt.	Each
326 46	Z16016001	160	6.5	#6	1	.42	\$23.98
326 49	Z16018001	180	7.0	#5	1	.50	\$25.98
326 52	Z16020001	200	8.0	#4	1	.55	\$28.98

High Leverage End Cutting Pliers



326 High Leverage End Cutting Pliers DIN ISO 5749 Low wear lap joint, riveted and able to withstand high levels of load. Low force action, clean cutting. Long life cutting edges are achieved through additional induction hardening to approx. 60 HRC. Special CV tool steel forgings hardened and tempered. Soft vinyl grips are oil & solvent resistant.

Item		↔	↔	Cutting Capacity	🔒	🔓	
No.		mm	Inch	Copper AWG	Pkg.	wt.	Each
326 57	Z17016001	160	6.5	#6	1	.41	\$16.98
326 58	Z17018001	180	7.0	#5	1	.61	\$18.98
326 59	Z17020001	200	8.0	#4	1	.75	\$22.98



Made in Germany

Wiha Vinyl Grip Pliers & Cutters

Carpenter's End Nippers



326 Carpenter's End Nippers DIN ISO 9243

High cutting performance and reduced effort achieved through the precise formation of the cutting blade after assembly. Long life cutting edges achieved by additional induction hardening. Special CV tool steel, hardened and tempered. Soft vinyl grips are oil & solvent resistant.

Item	↔ ↔		↔ ↵	
No.	mm	Inch	Pkg.	wt. Each
326 71 Z30018001	180	7.0	1	.62 \$15.98
326 72 Z30020001	200	8.0	1	.86 \$16.98

Mason Nippers



326 Mason Nippers DIN ISO 9243

High cutting performance and reduced effort achieved through the precise formation of the cutting blade after assembly. Long life induction hardened cutting edges. Special tool steel, hardened and tempered. Soft vinyl Grips are oil & solvent resistant.

Item	↔ ↔		Cutting Capacity	↵ ↵	
No.	mm	Inch	Hard Wire AWG	Pkg.	wt. Each
326 74 Z31022001	220	8.75	#12	1	.76 \$17.98
326 76 Z31025001	250	10.0	#12	1	.98 \$19.98
326 78 Z31028001	280	11.0	#12	1	1.00 \$21.98
326 80 Z31030001	300	12.0	#12	1	1.06 \$24.98



Made in Germany

Toll Free: (800) 494-6104

**Wiha Forged Retaining Ring Pliers**

**Retaining Ring Pliers - Internal**



**90° Angle Retaining Ring Pliers - Internal**



**Retaining Ring Pliers - External**



**90° Angle Retaining Ring Pliers - External**

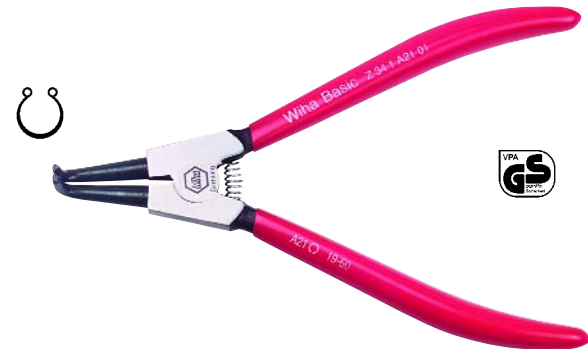

**326 Straight Internal Retaining Ring Pliers DIN ISO 5256**  
Shape C, straight tips. Die forged cylindrical precision formed. Chrome-vanadium special tool steel. For inserting & removing internal retaining rings.

Item	↔	↔	⊖	⊖	● Tip	☐	↶	↷	
No.	mm	Inch	Inch	mm	Inch/mm	Pkg.	wt.	Each	
326 81	Z330J0001	140	5.5	5/16-1/2	8-13	.035/.9	1	.19	\$15.98
326 82	Z330J1001	140	5.5	1/2-1	12-25	.050/1.3	1	.19	\$15.98
326 83	Z330J2001	170	6.7	3/4-2 3/8	19-60	.070/1.5	1	.42	\$16.98
326 84	Z330J3001	220	8.6	1 1/2-4	40-100	.090/2.3	1	.53	\$17.98

**326 90° Angle Internal Retaining Ring Pliers DIN ISO 5254**  
Shape D, 90° angled tips. Die forged cylindrical precision formed. CV Special tool steel. For inserting & removing internal retaining rings. Soft vinyl grips.

Item	↔	↔	⊖	⊖	● Tip	☐	↶	↷	
No.	mm	Inch	Inch	mm	Inch/mm	Pkg.	wt.	Each	
326 85	Z331J0101	125	4.9	5/16-1/2	8-13	.035/.9	1	.19	\$17.98
326 86	Z331J1101	125	4.9	1/2-1	12-25	.050/1.3	1	.19	\$17.98
326 87	Z331J2101	165	6.5	3/4-2 3/8	19-60	.070/1.5	1	.42	\$17.98
326 88	Z331J3101	210	8.2	1 1/2-4	40-100	.090/2.3	1	.53	\$18.98

**326 Straight External Retaining Ring Pliers DIN ISO 5254**  
Shape A, straight tips. Die forged cylindrical precision formed. CV special tool steel. For fitting & removing external retaining rings. Soft vinyl grips.

Item	↔	↔	⊖	⊖	● Tip	☐	↶	↷	
No.	mm	Inch	Inch	mm	Inch/mm	Pkg.	wt.	Each	
326 89	Z340A0001	140	5.5	1/8-3/8	3-10	.035/.9	1	.19	\$17.98
326 90	Z340A1001	140	5.5	3/8-1	10-25	.050/1.3	1	.19	\$17.98
326 91	Z340A2001	170	6.7	3/4-2 3/8	19-60	.070/1.5	1	.42	\$17.98
326 92	Z340A3001	220	8.6	1 1/2-4	40-100	.090/2.3	1	.53	\$19.98

**326 90° Angled External Retaining Ring Pliers DIN ISO 5254**  
Shape B, 90° angled tips. Die forged cylindrical precision formed. CV special tool steel. For fitting & removing external retaining rings. Soft vinyl grips.

Item	↔	↔	⊖	⊖	● Tip	☐	↶	↷	
No.	mm	Inch	Inch	mm	Inch/mm	Pkg.	wt.	Each	
326 94	Z341A0101	125	4.9	1/8-3/8	8-13	.035/.9	1	.19	\$18.98
326 95	Z341A1101	125	4.9	3/8-1	12-25	.050/1.3	1	.19	\$18.98
326 96	Z341A2101	165	6.5	3/4-2 3/8	19-60	.070/1.5	1	.42	\$19.98
326 97	Z341A3101	210	8.2	1 1/2-4	40-100	.090/2.3	1	.53	\$21.98



Made in Germany

www.wihatools.com

Wiha Long Life MaxiFlex Folding Rulers

From KWB division of Wiha in Switzerland



Patented play free joint with steel spring pin, wear resistant & maintenance free

90° positive stop joints

Reinforced with 30% fiberglass, rugged polyimide is scratch resistant

Deep embossed water proof scales

Tough and Flexible, impact resistant

Chemical and weather resistant for outdoor use

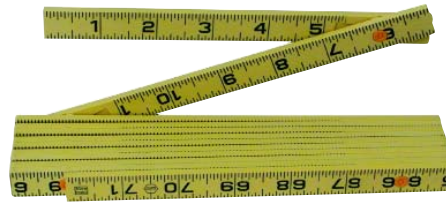

616 09 Inside Reading Long Life MaxiFlex Folding Rulers

Molded 30% fiber glass reinforced polyimide scratch, chemical & weather resistant both tough & flexible, impact resistant. Patented play free joint with steel spring is wear and maintenance free. 90° positive stop joints. Deep embossed scale on both sides of rules. Metric rules have 10cm red marking. Inch rules have 16" red stud wall marking.

Item								
No.	Ft.	Width	Sections	Increments	lbs.	pkg.	Each	
616 09	6'	5/8"	12	1/16"	.39	72	\$17.98	

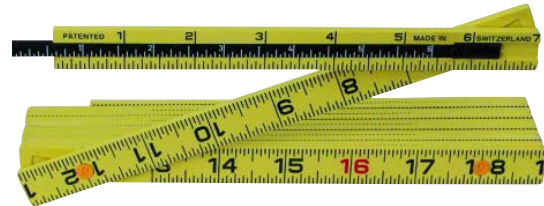

616 20 Outside Reading 6" Depth Extension Long Life MaxiFlex Folding Rulers

Molded 30% fiber glass reinforced polyimide scratch, chemical & weather resistant both tough & flexible, impact resistant. Patented play free joint with steel spring is wear and maintenance free. 90° positive stop joints. Deep embossed scale on both sides of rules. Metric rules have 10cm red marking. Inch rules have 16" red stud wall marking.

Item								
No.	Ft.	Depth	Width	Sections	Increments	lbs.	pkg.	Each
616 20	6'	6"	5/8"	12	1/16"	.40	72	\$18.98

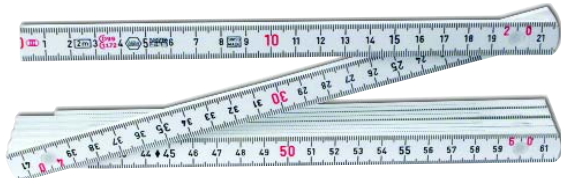

616 62 Combination Metric & Inch Long Life MaxiFlex Folding Rulers

Molded 30% fiber glass reinforced polyimide scratch, chemical & weather resistant both tough & flexible, impact resistant. Patented play free joint with steel spring is wear and maintenance free. 90° positive stop joints. Deep embossed scale on both sides of rules. Metric rules have 10cm red marking.

Item								
No.	Meter	Inch	Width	Sections	Increments	lbs.	pkg.	Each
616 62	2	78"	15mm	10	1/16 & 1mm	.31	72	\$9.98

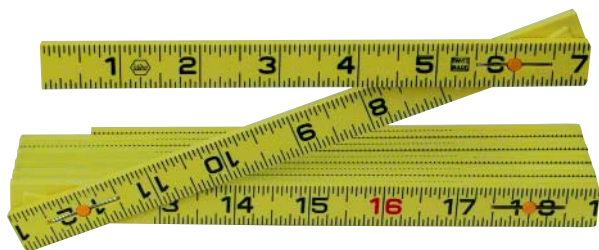

616 19 Outside Reading Long Life MaxiFlex Folding Rulers

Molded 30% fiber glass reinforced polyimide scratch, chemical & weather resistant both tough & flexible, impact resistant. Patented play free joint with steel spring is wear and maintenance free. 90° positive stop joints. Deep embossed scale on both sides of rules. Metric rules have 10cm red marking. Inch rules have 16" red stud wall marking.

Item								
No.	Ft.	Width	Sections	Increments	lbs.	pkg.	Each	
616 19	6'	5/8"	12	1/16"	.39	72	\$17.98	

616 02 Outside Reading Metric Long Life MaxiFlex Folding Rulers

Molded 30% fiber glass reinforced polyimide scratch, chemical & weather resistant both tough & flexible, impact resistant. Patented play free joint with steel spring is wear and maintenance free. 90° positive stop joints. Deep embossed scale on both sides of rules. Metric rules have 10cm red marking. Inch rules have 16" red stud wall marking.

Item								
No.	Meter	Width	Sections	Increments	lbs.	pkg.	Each	
616 02	2	15mm	10	1mm to CM	.31	72	\$9.98	



616 01 MaxiFlex Folding Rulers

Item								
No.	Inch/Meter	Width	Sections	Increments	lbs.	pkg.	Each	
616 01	39"/1	1/2"	10	1/16 & 1mm	.17	1	\$6.98	





Wiha ESD Safe Pliers & Cutters

Beveled Cutter      Semi-Flush Cutter

Flush Cutter      Ultra Full Flush

Box joint for longer tool life & endurance, mirror polished finish

Two component handle with non-slip soft grip surface, protects the hand and reduces manual effort & user fatigue

Welded double leaf spring

Hardened & annealed high carbon tool steel, induction hardened cutting edges

Diagonal Cutters Tapered Head

Form 1 - Semi Flush

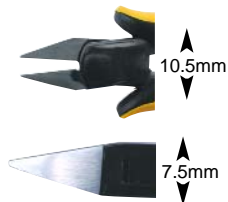

**327 03** Diagonal Cutters, Small Tapered Head, Form 1- Semi Flush

Side Cutters drop-forged for an ideal material structure. Precise aligned cutting edges are additionally induction hardened at a hardness of Approx. 64°HRC. Two component non-slip soft grip handle, ESD Safe Dissipative.

#327 03	mm	Inch	Copper	Iron	Steel	Head Wdth	Pkg.	wt.	Each
	115	4.5	1.0	0.6	0.3	10.5	1	.19	\$38.98

Diagonal Cutters Tapered Head

Form 2 - Flush

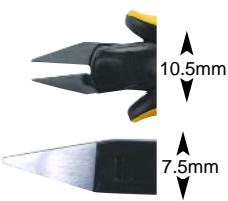

**327 05** Diagonal Cutters, Small Tapered Head, Form 2 - Flush

Side Cutters drop-forged for an ideal material structure. Precise aligned cutting edges are additionally induction hardened at a hardness of Approx. 64°HRC. Two component non-slip soft grip handle, ESD Safe Dissipative.

#327 05	mm	Inch	Copper	Iron	Steel	Head Wdth	Pkg.	wt.	Each
	115	4.5	1.0	-	-	10.5	1	.19	\$38.98

Diagonal Cutters Tapered Head

Form 3 - Semi Flush

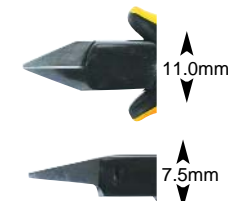

**327 02** Diagonal Cutters, Small Tapered Head With Hollow Ground Back, Form 3 - Semi Flush

Side Cutters drop-forged for an ideal material structure. Precise aligned cutting edges are additionally induction hardened at a hardness of Approx. 64°HRC. Two component non-slip soft grip handle, ESD Safe Dissipative.

#327 02	mm	Inch	Copper	Iron	Steel	Head Wdth	Pkg.	wt.	Each
	115	4.5	1.0	0.8	-	11.0	1	.19	\$39.98

Diagonal Cutters Tapered Head

Form 4 - Flush

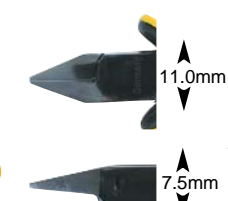

**327 04** Diagonal Cutters, Small Tapered Head With Hollow Ground Back, Form 4 - Flush

Side Cutters drop-forged for an ideal material structure. Precise aligned cutting edges are additionally induction hardened at a hardness of Approx. 64°HRC. Two component non-slip soft grip handle, ESD Safe Dissipative.

#327 04	mm	Inch	Copper	Iron	Steel	Head Wdth	Pkg.	wt.	Each
	115	4.5	1.0	-	-	11.0	1	.19	\$39.98





Made in Germany

Toll Free: (800) 494-6104

Wiha ESD Safe Pliers & Cutters

**Diagonal Cutters Wide Tapered Head**

Form 1 - Bevel

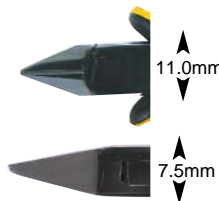

**327 06 Diagonal Cutters, Wide Tapered Head, Form 1- Bevel**

Side Cutters drop-forged for an ideal material structure. Precise aligned cutting edges are additionally induction hardened at a hardness of Approx. 64°HRC. Two component non-slip soft grip handle, ESD Safe Dissipative.

#327 06	mm	Inch	Copper	Iron	Steel	Head Wdth	Pkg.	wt.	Each
	115	4.5	1.4	1.0	0.4	11.0	1	.19	\$38.48

**Diagonal Cutters Wide Tapered Head**

Form 2 - Flush

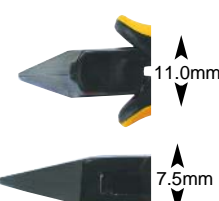

**327 08 Diagonal Cutters, Wide Tapered Head, Form 2 - Flush**

Side Cutters drop-forged for an ideal material structure. Precise aligned cutting edges are additionally induction hardened at a hardness of Approx. 64°HRC. Two component non-slip soft grip handle, ESD Safe Dissipative.

#327 08	mm	Inch	Copper	Iron	Steel	Head Wdth	Pkg.	wt.	Each
	115	4.5	1.2	-	-	11.0	1	.19	\$38.48

**Diagonal Cutters Wide Tapered Head**

Form 3 - Full Flush

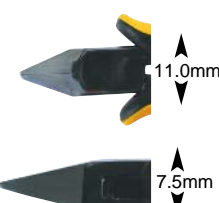

**327 10 Diagonal Cutters, Wide Tapered Head, Form 3 - Full Flush**

Side Cutters drop-forged for an ideal material structure. Precise aligned cutting edges are additionally induction hardened at a hardness of Approx. 64°HRC. Two component non-slip soft grip handle, ESD Safe Dissipative.

#327 10	mm	Inch	Copper	Iron	Steel	Head Wdth	Pkg.	wt.	Each
	115	4.5	1.0	-	-	11.0	1	.19	\$42.98

**Diagonal Cutters Wide Tapered Head**

Form 4 - Flush

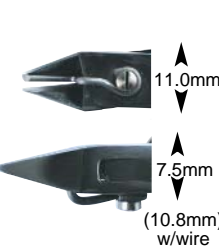

**327 11 Diagonal Cutters, Wide Tapered Head With Wire Trapping Device, Form 4 - Flush**

Side Cutters drop-forged for an ideal material structure. Precise aligned cutting edges are additionally induction hardened at a hardness of Approx. 64°HRC. Two component non-slip soft grip handle, ESD Safe Dissipative.

#327 11	mm	Inch	Copper	Iron	Steel	Head Wdth	Pkg.	wt.	Each
	115	4.5	1.2	-	-	11.0	1	.19	\$40.98

**Diagonal Cutters Slim Oval Form**

Form 1 - Flush

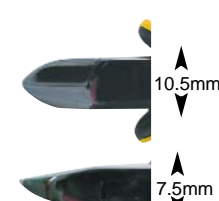

**327 12 Diagonal Cutters, Slim Oval Head, Form 1 - Flush**

Side Cutters drop-forged for an ideal material structure. Precise aligned cutting edges are additionally induction hardened at a hardness of Approx. 64°HRC. Two component non-slip soft grip handle, ESD Safe Dissipative.

#327 12	mm	Inch	Copper	Iron	Steel	Head Wdth	Pkg.	wt.	Each
	115	4.5	1.0	0.6	0.3	10.5	1	.19	\$38.98



Made in Germany

www.wihatools.com

**Wiha ESD Safe Pliers & Cutters**

**Diagonal Cutters Slim Oval Form**

Form 2 - Full Flush

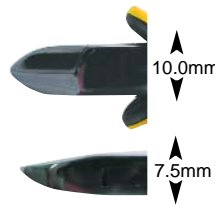
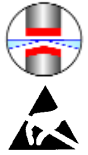

**327 14 Diagonal Cutters, Slim Oval Head, Form 2 - Full Flush**

Side Cutters drop-forged for an ideal material structure. Precise aligned cutting edges are additionally induction hardened at a hardness of Approx. 64°HRC. Two component non-slip soft grip handle, ESD Safe Dissipative.

#327 14	mm	Inch	Copper	Iron	Steel	Head Wdth	Pkg.	wt.	Each
	115	4.5	1.0	-	-	10.0	1	.19	\$42.98

**Diagonal Cutters Slim Oval Form**

Form 1 - Bevel

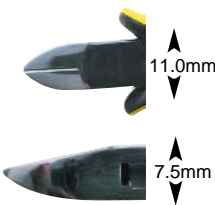
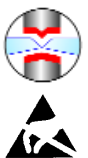

**327 16 Diagonal Cutters, Wide Oval Head, Form 1 - Bevel**

Side Cutters drop-forged for an ideal material structure. Precise aligned cutting edges are additionally induction hardened at a hardness of Approx. 64°HRC. Two component non-slip soft grip handle, ESD Safe Dissipative.

#327 16	mm	Inch	Copper	Iron	Steel	Head Wdth	Pkg.	wt.	Each
	115	4.5	1.4	1.0	0.4	11.0	1	.19	\$38.48

**Diagonal Cutters Wide Oval Form And Carbide Edge**

Form 4 - Bevel

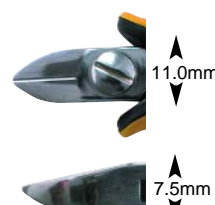

**327 18 Diagonal Cutters, Wide Oval Head Carbide Cutting Edges, Form 2 - Bevel**

Side Cutters drop-forged for an ideal material structure. Precise aligned carbide cutting edge. Two component non-slip soft grip handle, ESD Safe Dissipative.

#327 18	mm	Inch	Copper	Iron	Steel	Head Wdth	Pkg.	wt.	Each
	110	4 3/8	1.6	1.0	0.6	11.0	1	.16	\$89.98

**Diagonal Cutters Wide Oval Form**

Form 3 - Flush

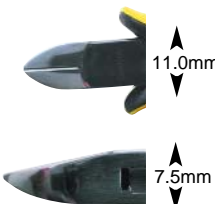
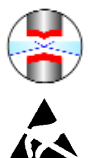

**327 20 Diagonal Cutters, Wide Oval Head, Form 3 - Flush**

Side Cutters drop-forged for an ideal material structure. Precise aligned cutting edges are additionally induction hardened at a hardness of Approx. 64°HRC. Two component non-slip soft grip handle, ESD Safe Dissipative.

#327 20	mm	Inch	Copper	Iron	Steel	Head Wdth	Pkg.	wt.	Each
	115	4.5	1.2	-	-	11.0	1	.19	\$38.48

**Diagonal Cutters Wide Oval Form**

Form 4 - Flush

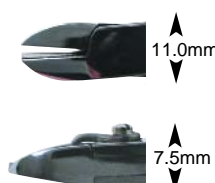
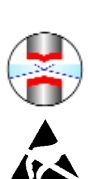

**327 21 Diagonal Cutters, Wide Oval Head With Wire Trapping Device, Form 4 - Flush**

Side Cutters drop-forged for an ideal material structure. Precise aligned cutting edges are additionally induction hardened at a hardness of Approx. 64°HRC. Two component non-slip soft grip handle, ESD Safe Dissipative.

#327 21	mm	Inch	Copper	Iron	Steel	Head Wdth	Pkg.	wt.	Each
	115	4.5	1.2	-	-	11.0	1	.19	\$39.98



Made in Germany

Toll Free: (800) 494-6104

**Wiha ESD Safe Pliers & Cutters**

**Oblique Angled Cutters**

Form 1 - Flush

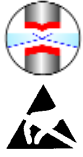

**327 22 Oblique Angled Cutters, 29°, Form 1- Flush**

Oblique Cutters drop-forged for an ideal material structure. Precise aligned cutting edges are additionally induction hardened at a hardness of Approx. 64°HRC. Two component non-slip soft grip handle, ESD Safe Dissipative.

#327 22	mm	Inch	Copper	Iron	Steel	Head Wdth	Pkg.	wt.	Each
	115	4.5	1.2	-	-	12.0	1	.20	\$44.48

**Oblique Angled Cutters**

Form 2 - Full Flush

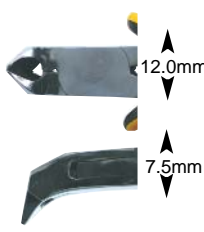
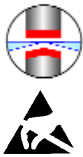

**327 24 Oblique Angled Cutters, 29°, Form 2 - Full Flush**

Oblique Cutters drop-forged for an ideal material structure. Precise aligned cutting edges are additionally induction hardened at a hardness of Approx. 64°HRC. Two component non-slip soft grip handle, ESD Safe Dissipative.

#327 24	mm	Inch	Copper	Iron	Steel	Head Wdth	Pkg.	wt.	Each
	115	4.5	1.0	-	-	12.0	1	.20	\$48.98

**Oblique Angled Cutters**

Form 3 - Semi Flush

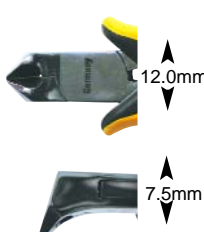
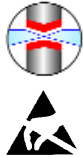

**327 26 Oblique Angled Cutters, 29°, Short Head, Form 3 - Semi Flush**

Oblique Cutters drop-forged for an ideal material structure. Precise aligned cutting edges are additionally induction hardened at a hardness of Approx. 64°HRC. Two component non-slip soft grip handle, ESD Safe Dissipative.

#327 26	mm	Inch	Copper	Iron	Steel	Head Wdth	Pkg.	wt.	Each
	115	4.5	1.2	0.8	0.6	12.0	1	.20	\$45.98

**Oblique Front Cutters**

Form 4 - Flush

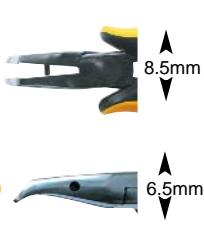
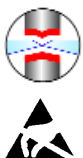

**327 28 Oblique Front Cutters, Very Small Head, 40°, Form 4 - Flush**

Oblique Cutters drop-forged for an ideal material structure. Precise aligned cutting edges are additionally induction hardened at a hardness of Approx. 64°HRC. Two component non-slip soft grip handle, ESD Safe Dissipative.

#327 28	mm	Inch	Copper	Iron	Steel	Head Wdth	Pkg.	wt.	Each
	110	4 3/8	0.6	-	-	8.5	1	.13	\$42.98



Made in Germany

www.wihatools.com

**Wiha ESD Safe Pliers & Cutters**

**End Cutters Extra Slim**

Form 1 - Semi Flush

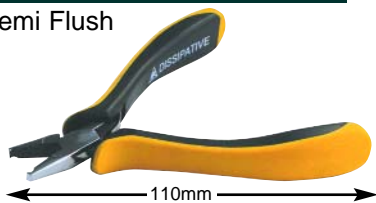
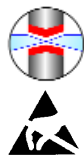

Tip Width

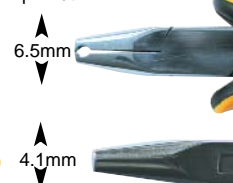

**327 32 End Cutters, Extra Slim, Form 1 - Flush**

End Cutters drop-forged for an ideal material structure. Precise aligned cutting edges are additionally induction hardened at a hardness of Approx. 64°HRC. Two component non-slip soft grip handle, ESD Safe Dissipative.

#327 32	mm	Inch	Copper	Iron	Steel	Tip Wdth	Pkg.	wt.	Each
	110	4 3/8	0.6	-	-	4.1	1	.16	\$43.48

**End Cutters Wide Head**

Form 2 - Flush

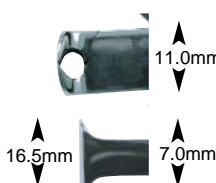
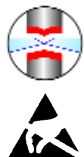

**327 34 End Cutters, Wide Head, Form 2 - Flush**

End Cutters drop-forged for an ideal material structure. Precise aligned cutting edges are additionally induction hardened at a hardness of Approx. 64°HRC. Two component non-slip soft grip handle, ESD Safe Dissipative.

#327 34	mm	Inch	Copper	Iron	Steel	Head Wdth	Pkg.	wt.	Each
	115	4.5	1.4	-	-	11.0	1	.18	\$43.98

**ESD Safe Pliers**

Short Snipe Nose

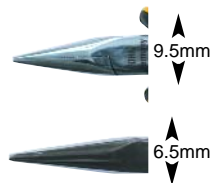

**327 42 ESD Safe Pliers, Short Snipe Nose (Chain Nose) Straight, Serrated Jaws**

Pliers drop-forged for an ideal material structure. Precisely aligned, jaws, hardened. Two component non-slip soft grip handle, ESD Safe Dissipative.

#327 42	mm	Inch	Copper	Iron	Steel	Head Wdth	Pkg.	wt.	Each
	120	4 3/4	-	-	-	9.5	1	.17	\$34.98

**ESD Safe Pliers**

Snipe Nose

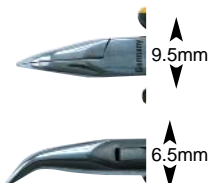

**327 44 ESD Safe Pliers, Snipe Nose (Chain Nose) Bent 45°, Smooth Jaws**

Pliers drop-forged for an ideal material structure. Precisely aligned, jaws, hardened. Two component non-slip soft grip handle, ESD Safe Dissipative.

#327 44	mm	Inch	Copper	Iron	Steel	Head Wdth	Pkg.	wt.	Each
	120	4 3/4	-	-	-	9.5	1	.16	\$35.98

**ESD Safe Pliers**

Long Needle Nose

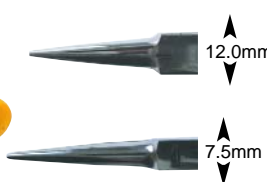

**327 46 ESD Safe Pliers, Long Needle Nose Pliers, Straight, Serrated Jaws**

Pliers drop-forged for an ideal material structure. Precisely aligned, jaws, hardened. Two component non-slip soft grip handle, ESD Safe Dissipative.

#327 46	mm	Inch	Copper	Iron	Steel	Head Wdth	Pkg.	wt.	Each
	145	5 3/4	-	-	-	12.0	1	.21	\$39.98



Made in Germany

Toll Free: (800) 494-6104

**Wiha ESD Safe Pliers & Cutters**

**ESD Safe Pliers**

Needle Nose, Bent 90°

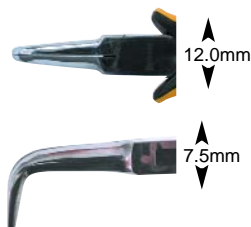

**327 48 ESD Safe Pliers, Needle Nose Pliers, Bent 90°, Smooth Jaws**

Pliers drop-forged for an ideal material structure. Precisely aligned, jaws, hardened. Two component non-slip soft grip handle, ESD Safe Dissipative.

#327 48	mm	Inch	Copper	Iron	Steel	Head Wdth	Pkg.	wt.	Each
	145	5 3/4	-	-	-	12.0	1	.21	\$39.98

**ESD Safe Pliers**

Short Round Nose Pliers

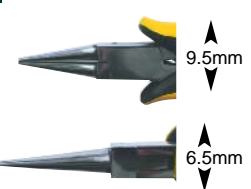

**327 50 ESD Safe Pliers, Short Round Nose Pliers, Smooth Jaws**

Pliers drop-forged for an ideal material structure. Precisely aligned, jaws, hardened. Two component non-slip soft grip handle, ESD Safe Dissipative.

#327 50	mm	Inch	Copper	Iron	Steel	Head Wdth	Pkg.	wt.	Each
	120	4 3/4	-	-	-	9.5	1	.17	\$34.98

**ESD Safe Pliers**

Short Flat Nose Pliers

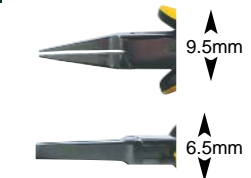

**327 52 ESD Safe Pliers, Short Flat Nose Pliers, Smooth Jaws**

Pliers drop-forged for an ideal material structure. Precisely aligned, jaws, hardened. Two component non-slip soft grip handle, ESD Safe Dissipative.

#327 52	mm	Inch	Copper	Iron	Steel	Head Wdth	Pkg.	wt.	Each
	120	4 3/4	-	-	-	9.5	1	.16	\$34.98



**327 90 4 Pc. ESD Safe Pliers Set In Custom Case**

Pliers drop-forged for an ideal material structure. Two component non-slip soft grip handle. ESD Safe Dissipative.

#327 90 4 piece ESD Safe Pliers Set

Set includes:

32716 Oval Side Cutters	32746 Long Nose Pliers
32752 Flat Nose Pliers	32728 Oblique Cutters

Each \$169.98



**327 91 11 Pc. Set, 4 ESD Safe Pliers, SYSTEM 4 Slotted & Phillips 5 Pc. Set & 2 ESD Safe Tweezers**

Pliers drop-forged for an ideal material structure. Two component non-slip soft grip handle. ESD Safe Precision handle & 4 CVM tool steel blades. Tweezers anti-static conductive, ESD Safe Hypo allergenic, anti magnetic stainless.

#327 91 11 piece ESD Safe Pliers, Tweezers & SYS 4 precision

Set in custom case includes: Each \$229.98

**ESD Safe Pliers & Cutters**

32716 Oval Side Cutters	32746 Long Nose Pliers
32752 Flat Nose Pliers	32728 Oblique Cutters

**SYSTEM 4 Set in separate pouch**

28000 ESD Safe Conductive Precision Handle

Slotted: 1.5, 2.0, 3.0 & 4.0 Phillips: 000, 00, 0 & 1

ESD Safe Tweezers: 44501 AA SA ESD 44510 7a SA ESD

Each \$229.98



Made in Germany

Wiha Precision Index

	Description	Page
	ESD Safe Slotted Prec Drivers	110-111
	ESD Safe Phillips Prec Drivers	110-111
	ESD Safe Torx Prec Drivers	111
	ESD Safe Hex Prec Drivers	112
	ESD Safe Nut Drivers	112
	ESD Safe Chip Lifter	117
	Ceramic Slotted/Phillips Drivers	112
	Precision Slotted Drivers	113-114
	Precision Phillips Drivers	113-114
	Precision Pozidriv Drivers	115
	Precision Hex Drivers	114
	Precision Ball End Hex Drivers	115
	Precision Nut Drivers	116
	Precision Torx Drivers	117
	Precision Chip Lifter	117
	Pocket Clip	117
	Precision Tool Rack	117
	Protorn Prec Slotted Drivers	118
	Protorn Prec Phillips Drivers	118
	Protorn Prec Hex Drivers	119
	Protorn Prec Ball End Drivers	119
	Protorn Bit Holding Driver	119
	Protorn Chip Lifter	119
	Protorn Torx Drivers	120
	SYSTEM 4 Handles	122
	SYSTEM 4 Blades	122-123
	SYSTEM 4 Sets	124-126
	SYSTEM 4 Micro Bit Handles	127
	SYSTEM 4 Micro Bits	127-128
	SYSTEM 4 Micro Bit Sets	128-129

Precision ESD Safe Conductive Drivers

Wiha Precision ESD Static Dissipative Screwdrivers meet the requirements for tools used in electrostatic sensitive areas.



**Rotating cap** for precise turning & control with fingertip

**Molded Precision handle** of impact resistant conductive material

**Tapered handle** allows rapid rotation

**Blade, CVM steel, hardened, chrome-plated.**

**Tip, precision ground for exact fit, Wiha Chromtop finish.**

Surface resistance of handles is 10<sup>6</sup> - 10<sup>9</sup> Ohms.



**272 Slotted Screwdriver, With Precision ESD Safe Conductive Handle.** Blade high alloy chrome-vanadium-molybdenum steel, hardened, chrome-plated, tip Wiha-Chromtop. Handle manufactured from impact resistant, conductive material.

Item														
No.	mm	Inch	mm	Inch	mm	Inch	mm	Inch	lbs.	pkg.	Each			
272 15	1.5	1/16	40	1.6	0.25	.010	120	4.72	.02	10	\$5.20			
272 20	2.0	5/64	40	1.6	0.40	.016	120	4.72	.02	10	\$4.48			
272 25	2.5	3/32	50	2.0	0.40	.016	145	5.71	.04	10	\$4.48			
272 30	3.0	1/8	50	2.0	0.50	.020	145	5.71	.04	10	\$4.08			
272 35	3.5	9/64	60	2.4	0.60	.024	170	6.69	.06	10	\$4.88			
272 40	4.0	5/32	60	2.4	0.80	.031	170	6.69	.06	10	\$4.98			



**273 Phillips Screwdriver, With Precision ESD Safe Conductive Handle.** Blade high alloy chrome-vanadium-molybdenum steel, hardened, chrome-plated, tip Wiha-Chromtop. Handle manufactured from impact resistant, conductive material.

Item													
No.	Size	mm	Inch	mm	Inch	mm	Inch	lbs.	pkg.	Each			
273 02	000	40	1.6	2.0	.079	120	4.7	.02	10	\$6.90			
273 05	00	40	1.6	2.0	.079	120	4.7	.02	10	\$5.10			
273 10	0	50	2.0	3.0	.118	145	5.7	.04	10	\$4.80			
273 20	1	60	2.3	4.0	.157	170	6.7	.06	10	\$4.88			



Made in Germany

Toll Free: (800) 494-6104

**Precision ESD Safe Conductive Drivers**



**273 90 Set 7 Pcs. Slotted & Phillips Precision ESD Safe Conductive Handle.** Blade high alloy CVM steel, hardened, chrome-plated, tip Wiha-Chromtop. Handle manufactured from impact resistant, conductive material.

Item No.	Slotted mm	Phillips mm	Size	Weight lbs.
273 90	272 15	1.5 40	273 05 00 40	.30
	272 20	2.0 40	273 10 0 50	
	272 25	2.5 50	273 20 1 60	Each
	272 35	3.5 60		\$31.98



**920 91 Master Technicians Bench Top Set**  
Plexiglass frame. Equipped with 34 precision ESD Safe screwdrivers.

Item No.	Contents
920 91	Slotted: 1.5, 2.0, 2.5, 3.0, 3.5, 4.0mm Phillips: #00, #0, #1 Torx: T1, T2, T3, T4, T5, T6, T7, T8, T9, T10, T15, T20 Metric Hex: 1.3, 1.5, 2.0, 2.5, 3.0 Metric Nut Drivers: 2.5, 3.0, 3.5, 4.0, 4.5, 5.0, 5.5 279 20 Chip Lifter
	Each \$183.40



**278 TORX® Screwdriver, With Precision ESD Safe Conductive handle.** Blade high alloy CVM steel, hardened, chrome-plated, tip Wiha-Chromtop. Handle impact resistant, conductive material.

Item No.	Size	mm	Inch	mm	Inch	lbs.	pkg.	Each
278 01	T1	40	1.57	120	4.7	.03	10	\$6.62
278 02	T2	40	1.57	120	4.7	.03	10	\$6.62
278 03	T3	40	1.57	120	4.7	.03	10	\$6.62
278 04	T4	40	1.57	120	4.7	.03	10	\$6.62
278 05	T5	40	1.57	120	4.7	.03	10	\$6.62
278 11	T6	40	1.57	120	4.7	.03	10	\$6.62
278 17	T7	40	1.57	120	4.7	.03	10	\$6.62
278 23	T8	40	1.57	120	4.7	.03	10	\$6.62
278 29	T9	50	1.97	145	5.7	.04	10	\$6.62
278 35	T10	50	1.97	145	5.7	.04	10	\$6.92
278 41	T15	60	2.36	170	6.7	.07	10	\$7.02
278 47	T20	60	2.36	170	6.7	.07	10	\$7.14



**278 90 Set 7 Pcs. TORX® Precision ESD Safe conductive handle**  
Blade high alloy CVM steel, hardened, chrome-plated, tip Wiha-Chromtop. Handle manufactured from impact resistant, conductive material.

Item No.	Slotted mm	Phillips mm	Size	Weight lbs.
278 90	272 15	T4 40	273 05 T8 40	.31
	272 20	T5 40	273 10 T9 50	
	272 25	T6 40	273 20 T10 50	Each
	272 35	T7 40		\$33.98



**278 91 Set 7 Pcs. TORX® Precision ESD Safe conductive handle**  
Blade high alloy CVM steel, hardened, chrome-plated, tip Wiha-Chromtop. Handle manufactured from impact resistant, conductive material.

Item No.	Slotted mm	Phillips mm	Size	Weight lbs.	
278 91	278 01	T1 40	278 05	T5 40	.30
	278 02	T2 40	278 06	T6 40	
	278 03	T3 40	278 07	T7 40	Each
	278 04	T4 40	279 20	Chip Lifter	\$49.98



Made in Germany

www.wihatools.com

**Wiha Precision ESD Safe Screwdrivers**



**275 Metric Hex Driver, With Precision ESD Safe Conductive Handle.**

Blade high alloy chrome-vanadium-molybdenum steel, hardened, chrome-plated, tip Wiha-Chromtop. Handle manufactured from impact resistant, conductive material.

Item									
No.	mm	mm	Inch	mm	Inch	lbs.	pkg.	Each	
275 13	1.3	40	1.6	120	4.72	.03	10	\$4.90	
275 15	1.5	50	2.0	145	5.71	.03	10	\$4.60	
275 20	2.0	50	2.0	145	5.71	.04	10	\$4.18	
275 25	2.5	60	2.4	170	6.69	.05	10	\$4.28	
275 30	3.0	60	2.4	170	6.69	.06	10	\$3.98	



**277 Metric Nut Driver, With Precision ESD Safe Conductive Handle.**

Blade high alloy chrome-vanadium-molybdenum steel, hardened, chrome-plated, tip Wiha-Chromtop. Handle manufactured from impact resistant, conductive material.

Item										
No.	mm	mm	Inch	mm	Inch	Inch	Inch	lbs.	pkg.	Each
277 25	2.5	60	2.36	155	6.1	4.0	4.0	.05	10	\$6.02
277 30	3.0	60	2.36	155	6.1	5.0	5.0	.06	10	\$6.32
277 35	3.5	60	2.36	155	6.1	5.3	6.0	.06	10	\$6.52
277 40	4.0	60	2.36	155	6.1	5.5	6.0	.06	10	\$6.74
277 50	5.0	60	2.36	155	6.1	6.8	7.0	.06	10	\$6.74
277 55	5.5	60	2.36	170	6.7	7.6	8.0	.07	10	\$6.94



**Wiha Precision Ceramic**

Handle and Blade are antimagnetic and anti-static.

Rotating cap facilitates adjusting and holding of the tools.



Blade High thermic and electric insulation.

Precision handle high quality plastic, cadmium free.

Free of contamination, suited for working in clean-rooms.



**270 Ceramic Slotted Screwdriver, With Wiha-Precision Handle, Out of Anti-static Plastic.**

Blade special ceramic, anti-static, antimagnetic, for correct adjusting in high frequency areas.

Item												
No.	mm	Inch	mm	Inch	mm	Inch	mm	Inch	lbs.	pkg.	Each	
270 09	0.9	.035	15	.591	0.35	.014	94.5	3.72	.14	1	\$11.10	
270 13	1.3	.050	15	.591	0.35	.014	94.5	3.72	.14	1	\$11.10	
270 18	1.8	.071	15	.591	0.45	.018	94.5	3.72	.14	1	\$11.10	
270 26	2.6	.102	15	.591	0.45	.018	94.5	3.72	.14	1	\$11.10	



**271 Ceramic Phillips Screwdriver, With Wiha-Precision Handle, Out of Anti-static Plastic.**

Blade special ceramic, anti-static, antimagnetic, for correct adjusting in high frequency areas.

Item								
No.	Size	mm	Inch	mm	Inch	lbs.	pkg.	Each
271 00	0	15.0	.591	94.5	3.72	.14	1	\$11.10



**270 90 Ceramic Slotted/Phillips Screwdriver 3 Pc. Set, With Wiha-Precision Handle, Out of Anti-static Plastic.**

Blade special ceramic, anti-static, antimagnetic, for correct adjusting in high frequency areas.

Item							
No.	mm	mm	Size	mm	lbs.	pkg.	Each
270 90	0.9	15	0	15	.28	1	\$33.98
	2.6	15					

See Precision tool stand on page 117





Made in Germany

Toll Free: (800) 494-6104

**Wiha Long Life Precision Series**



**260 Slotted Screwdriver, With Precision Handle**  
Blade high alloy chrome-vanadium-molybdenum steel.

Item	+	+	+	+	+	+	+	+	+	+	+
No.	mm	Inch	mm	Inch	mm	Inch	mm	Inch	lbs.	pkg.	Each
260 08	.80	1/32	40	1.6	0.16	.007	120	4.72	.02	10	\$5.20
260 10	1.0	.039	40	1.6	0.18	.007	120	4.72	.02	10	\$4.80
260 12	1.2	3/64	40	1.6	0.20	.008	120	4.72	.02	10	\$3.90
260 15	1.5	1/16	40	1.6	0.25	.010	120	4.72	.02	10	\$3.80
260 18	1.8	.070	40	1.6	0.30	.012	120	4.72	.02	10	\$3.50
260 20	2.0	5/64	40	1.6	0.40	.016	120	4.72	.02	10	\$3.20
260 22	2.0	5/64	50	2.0	0.40	.016	145	5.71	.02	10	\$3.50
260 23	2.0	5/64	100	4.0	0.40	.016	180	7.09	.03	10	\$3.50
260 25	2.5	3/32	50	2.0	0.40	.016	145	5.71	.03	10	\$3.20
260 27	2.5	3/32	100	3.9	0.40	.016	195	7.68	.03	10	\$3.30
260 28	2.5	3/32	150	6.0	0.40	.016	245	9.61	.04	10	\$3.50
260 30	3.0	1/8	50	2.0	0.50	.020	145	5.71	.03	10	\$3.20
260 32	3.0	1/8	60	2.4	0.50	.020	170	6.69	.04	10	\$3.40
260 33	3.0	1/8	100	4.0	0.50	.020	210	8.27	.04	10	\$3.40
260 34	3.0	1/8	150	6.0	0.50	.020	260	10.24	.05	10	\$3.80
260 35	3.5	9/64	60	2.4	0.60	.024	170	6.69	.05	10	\$3.50
260 40	4.0	5/32	60	2.4	0.80	.031	170	6.69	.05	10	\$3.60
260 41	4.0	5/32	100	3.9	0.80	.031	210	8.27	.06	10	\$3.80
260 42	4.0	5/32	150	6.0	0.80	.031	260	10.24	.07	10	\$4.30

**260 90 Set 6 Pcs. Slotted**  
Blade high alloy chrome-vanadium-molybdenum steel, hardened, chrome-plated.

Item	+	+	+	
No.	mm	mm	lbs.	
260 90	260 15	1.5	40	.27
	260 20	2.0	40	
	260 25	2.5	50	
	260 30	3.0	50	
	260 35	3.5	60	Each
	260 40	4.0	60	\$20.98



**261 Phillips Screwdriver, With Precision Handle**  
Blade high alloy chrome-vanadium-molybdenum steel.

Item	+	+	+	+	+	+	+	+	+	+	+
No.	Size	mm	Inch	mm	Inch	mm	Inch	lbs.	pkg.	Each	
261 02	000	40	1.6	2.0	.079	120	4.7	.02	10	\$5.10	
261 00	00	40	1.6	2.0	.079	120	4.7	.02	10	\$3.90	
261 01	00	75	3.0	2.0	.079	155	6.1	.02	10	\$3.90	
261 05	0	50	2.0	3.0	.118	145	5.7	.02	10	\$3.50	
261 08	0	75	3.0	3.0	.118	170	6.7	.03	10	\$3.40	
261 07	0	100	4.0	3.0	.118	195	7.6	.05	10	\$3.60	
261 09	0	150	5.9	3.0	.118	245	9.6	.06	10	\$3.90	
261 10	1	60	2.4	4.0	.157	170	6.7	.05	10	\$3.60	
261 13	1	80	3.1	4.0	.157	190	7.5	.05	10	\$3.80	
261 14	1	100	3.9	4.0	.157	210	8.2	.06	10	\$3.80	
261 15	1	150	5.9	4.0	.157	260	10.2	.07	10	\$4.30	

**Rotating cap**  
for precise turning and control with fingertip.

**Precision handle**  
high quality plastic, cadmium free.

**Molded on tapered handle**  
allows rapid rotation.

**High performance blades**  
chrome-vanadium-molybdenum steel, hardened, chrome-plated.

**Tip**  
precision ground for exact fit. Vapor chromed non-slip surface.

See Carded Precision Screwdrivers On Page 121



Made in Germany

www.wihatools.com

**Wiha Precision Series**



**261 90 Set 7 Pcs. Slotted & Phillips**  
Blade high alloy chrome-vanadium-molybdenum steel.

Item	Slotted	Phillips	Weight	
No.	mm	mm	lbs.	
261 90	260 15	1.5	40	.31
	260 22	2.0	50	
	260 25	2.5	50	
	260 32	3.0	60	
		Phillips	mm	mm
	261 00	00	40	
	261 05	0	50	Each
	261 10	1	60	\$23.98



**260 92 Set 7 Pcs. Slotted & Phillips**  
Blade high alloy chrome-vanadium-molybdenum steel.

Item	Slotted	Phillips	Weight	
No.	mm	mm	lbs.	
260 92	260 25	2.5	50	.30
	260 27	2.5	100	
	260 33	3.0	100	
	260 34	3.0	150	
	260 41	4.0	100	
	260 42	4.0	150	
		Phillips	mm	mm
	261 08	0	75	Each \$25.98

#26092  
**261 94 Set 4 Pcs. Phillips**  
Blade high alloy chrome-vanadium-molybdenum steel.  
Item No. 261 94 000 x 40, 00 x 40, 0 x 50, 1 x 60 Each \$16.98



**261 92 Set 5 Pcs. Slotted & Phillips**  
Blade high alloy chrome-vanadium-molybdenum steel.

Item	Slotted	Phillips	Weight	
No.	mm	mm	lbs.	
261 92	260 28	2.5	150	.44
	260 34	3.0	150	
	260 42	4.0	150	
		Phillips	mm	mm
	261 09	0	150	Each
	261 15	1	150	\$20.98



**263 Metric Hex Driver, With Precision Handle**  
Metric sizes. Blade high alloy chrome-vanadium-molybdenum steel.

Item	Hex	Slotted	Phillips	Weight					
No.	mm	Inch	mm	Inch	mm	Inch	lbs.	pkg.	Each
263 07	0.7	.028	40	1.6	120	4.72	.02	10	\$3.90
263 09	0.9	.035	40	1.6	120	4.72	.02	10	\$3.80
263 13	1.27	.050	40	1.6	120	4.72	.02	10	\$3.30
263 15	1.5	-	50	2.0	145	5.71	.03	10	\$3.30
263 20	2.0	5/64	50	2.0	145	5.71	.03	10	\$3.00
263 25	2.5	-	60	2.4	170	6.69	.04	10	\$3.00
263 30	3.0	-	60	2.4	170	6.69	.04	10	\$3.00



**263 90 Set 7 Pcs. Hex Driver Metric**  
Blade high alloy chrome-vanadium-molybdenum steel.

Item	Hex	Slotted	Phillips	Weight
No.	mm	mm	lbs.	
263 90	263 07	0.7	40	.28
	263 09	0.9	40	
	263 13	1.3	40	
	263 15	1.5	50	
	263 20	2.0	50	
	263 25	2.5	60	Each
	263 30	3.0	60	\$23.98



**263 Inch Hex Driver, With Precision Handle**  
Inch sizes. Blade high alloy chrome-vanadium-molybdenum steel.

Item	Hex	Slotted	Phillips	Weight					
No.	Inch	mm	mm	Inch	mm	Inch	lbs.	pkg.	Each
263 07	.028	0.7	40	1.6	120	4.72	.02	10	\$3.90
263 09	.035	0.9	40	1.6	120	4.72	.02	10	\$3.80
263 13	.050	1.27	40	1.6	120	4.72	.02	10	\$3.30
263 16	1/16	-	50	2.0	145	5.71	.03	10	\$3.30
263 20	5/64	2.0	50	2.0	145	5.71	.03	10	\$3.00
263 23	3/32	-	60	2.4	170	6.70	.04	10	\$3.00
263 27	7/64	-	60	2.4	170	6.70	.04	10	\$3.00
263 31	1/8	-	60	2.4	170	6.70	.04	10	\$3.00



**263 91 Set 8 Pcs. Hex Driver Inch**  
Blade high alloy chrome-vanadium-molybdenum steel.

Item	Hex	Slotted	Phillips	Weight
No.	Inch	Inch	lbs.	
263 91	263 07	.028	1.6	.32
	263 09	.035	1.6	
	263 13	.050	1.6	
	263 16	1/16	2.0	
	263 20	5/64	2.0	
	263 23	3/32	2.4	
	263 27	7/64	2.4	Each
	263 31	1/8	2.4	\$25.98



Made in Germany

Toll Free: (800) 494-6104

**Wiha Precision Series**

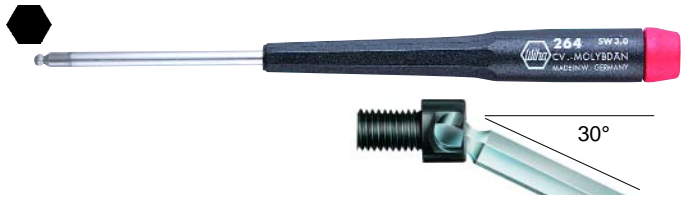

**264 Inch Ball End, Hex Driver, Inch, With Precision Handle**

Angle entry up to 30°. Blade high alloy chrome-vanadium-molybdenum steel.

Item									
No.	Inch	mm	Inch	mm	Inch	lbs.	pkg.	Each	
264 13	.050	40	1.57	120	4.72	.02	10	\$3.90	
264 16	1/16	50	1.97	145	5.71	.03	10	\$3.90	
264 19	5/64	50	1.97	145	5.71	.03	10	\$3.90	
264 23	3/32	50	1.97	145	5.71	.03	10	\$3.90	
264 27	7/64	60	2.36	170	6.69	.03	10	\$3.90	
264 31	1/8	60	2.36	170	6.69	.05	10	\$3.90	
264 36	9/64	60	2.36	170	6.69	.05	10	\$3.90	
264 39	5/32	60	2.36	170	6.69	.05	10	\$3.90	



**264 Metric Ball End, Hex Driver, Metric, With Precision Handle**

Angle entry up to 30°. Blade high alloy chrome-vanadium-molybdenum steel.

Item									
No.	mm	Inch	mm	Inch	mm	Inch	lbs.	pkg.	Each
264 13	1.3	.050	40	1.57	120	4.72	.02	10	\$3.90
264 15	1.5	-	50	1.97	145	5.71	.03	10	\$3.90
264 20	2.0	-	50	1.97	145	5.71	.03	10	\$3.90
264 25	2.5	-	60	2.36	170	6.69	.04	10	\$3.90
264 30	3.0	-	60	2.36	170	6.69	.05	10	\$3.90



**264 90 Set 8 Pcs. Ball End Hex Driver**

Inch Angle entry up to 30°. Blade high alloy chrome-vanadium-molybdenum steel.

Item				
No.	Inch	Inch	lbs.	
264 90	264 13	.050	1.6	.40
	264 16	1/16	2.0	
	264 19	5/64	2.0	
	264 23	3/32	2.0	
	264 27	7/64	2.4	
	264 31	1/8	2.4	
	264 36	9/64	2.4	Each
	264 39	5/32	2.4	\$30.98



**264 91 Set 5 Pcs. Ball End Hex Driver**

Metric Angle entry up to 30°. Blade high alloy chrome-vanadium-molybdenum-steel.

Item				
No.	mm	mm	lbs.	
264 91	264 13	1.3	40	.25
	264 15	1.5	50	
	264 20	2.0	50	
	264 25	2.5	60	Each
	264 30	3.0	60	\$18.98



**262 Pozidriv® Screwdriver, With Precision Handle**

Blade high alloy chrome-vanadium-molybdenum steel.

Item										
No.	Size	mm	Inch	mm	Inch	mm	Inch	lbs.	pkg.	Each
262 05	0	50	2.0	3.0	.118	145	5.7	.03	10	\$3.60
262 10	1	60	2.4	4.0	.157	170	6.7	.05	10	\$3.60



Made in Germany

www.wihatools.com

**Wiha Precision Series**



**265 Metric Nut Driver, With Precision Handle**

Metric sizes. Blade CVM steel, hardened, chrome-plated.

Item	⊙	⊖	⊖	⊖	⊖	⊖	⊖	⊖	⊖	⊖	⊖
No.	mm	mm	Inch	mm	Inch	mm	mm	lbs.	pkg.	Each	
265 10	1.5	60	2.36	140	5.5	2.5	3.0	.03	10	\$3.90	
265 15	1.8	60	2.36	140	5.5	2.9	3.5	.03	10	\$3.90	
265 20	2.0	60	2.36	140	5.5	3.2	4.0	.04	10	\$4.10	
265 25	2.5	60	2.36	155	6.1	4.0	4.0	.04	10	\$4.20	
265 30	3.0	60	2.36	155	6.1	5.0	5.0	.05	10	\$4.30	
265 32	3.2	60	2.36	155	6.1	5.0	5.0	.05	10	\$4.40	
265 35	3.5	60	2.36	155	6.1	5.3	6.0	.05	10	\$4.50	
265 40	4.0	60	2.36	155	6.1	5.5	6.0	.05	10	\$4.50	
265 45	4.5	60	2.36	155	6.1	6.2	7.0	.05	10	\$4.60	
265 50	5.0	60	2.36	155	6.1	6.8	7.0	.05	10	\$4.60	
265 55	5.5	60	2.36	170	6.7	7.6	8.0	.06	10	\$4.80	
265 60	6.0	60	2.36	170	6.7	8.2	9.0	.06	10	\$4.80	
265 70	7.0	60	2.36	170	6.7	9.6	10.0	.06	10	\$4.80	

**265 Inch Nut Driver, With Precision Handle**

Inch sizes. Blade CVM steel, hardened, chrome-plated.

Item	⊙	⊖	⊖	⊖	⊖	⊖	⊖	⊖	⊖	⊖
No.	Inch	mm	Inch	mm	Inch	Inch	Inch	lbs.	pkg.	Each
265 23	3/32	60	2.36	155	6.1	.16	.16	.04	10	\$4.20
265 27	7/64	60	2.36	155	6.1	.20	.20	.05	10	\$4.20
265 31	1/8	60	2.36	155	6.1	.20	.20	.05	10	\$4.50
265 36	9/64	60	2.36	155	6.1	.21	.24	.05	10	\$4.50
265 39	5/32	60	2.36	155	6.1	.22	.24	.05	10	\$4.60
265 47	3/16	60	2.36	155	6.1	.25	.28	.05	10	\$4.60
265 56	7/32	60	2.36	170	6.7	.30	.32	.06	10	\$4.80
265 63	1/4	60	2.36	170	6.7	.34	.36	.06	10	\$4.80



**265 90 Set 8 Pcs. Nut Driver Metric**

Blade chrome-vanadium-molybdenum steel.

Item	⊙	⊖	⊖
No.	mm	mm	lbs.
265 90	265 25	2.5	60 .48
	265 30	3.0	60
	265 35	3.5	60
	265 40	4.0	60
	265 45	4.5	60
	265 50	5.0	60
	265 55	5.5	60 Each
	265 60	6.0	60 \$36.98



**265 91 Set 8 Pcs. Nut Driver Inch**

Blade chrome-vanadium-molybdenum steel.

Item	⊙	⊖	⊖
No.	Inch	Inch	lbs.
265 91	265 23	3/32	2.4 .47
	265 27	7/64	2.4
	265 31	1/8	2.4
	265 36	9/64	2.4
	265 39	5/32	2.4
	265 47	3/16	2.4
	265 56	7/32	2.4 Each
	265 63	1/4	2.4 \$35.98



**265 92 Set 7 Pcs. Nut Driver Metric**

Blade chrome-vanadium-molybdenum steel.

Item	⊙	⊖	⊖
No.	mm	mm	lbs.
265 92	265 10	1.5	60 .34
	265 15	1.8	60
	265 20	2.0	60
	265 25	2.5	60
	265 30	3.0	60
	265 35	3.5	60 Each
	265 40	4.0	60 \$28.98



Made in Germany

Toll Free: (800) 494-6104

**Wiha Precision Series**



**267 TORX® Screwdriver, With Precision Handle**

Blade high alloy chrome-vanadium-molybdenum steel.

Item	Icon	mm	Inch	mm	Inch	lbs.	pkg.	Each
267 03	T3	40	1.57	120	4.7	.02	10	\$4.50
267 04	T4	40	1.57	120	4.7	.02	10	\$4.50
267 05	T5	40	1.57	120	4.7	.02	10	\$4.50
267 06	T6	40	1.57	120	4.7	.02	10	\$4.60
267 07	T7	40	1.57	120	4.7	.02	10	\$4.60
267 08	T8	40	1.57	120	4.7	.03	10	\$4.60
267 09	T9	50	1.97	145	5.7	.03	10	\$4.60
267 10	T10	50	1.97	145	5.7	.03	10	\$4.80
267 15	T15	60	2.36	170	6.7	.05	10	\$4.80
267 20	T20	60	2.36	170	6.7	.05	10	\$4.80



**267 90 Set 6 Pcs. TORX® Screwdriver**

Blade high alloy chrome-vanadium-molybdenum steel.

Item	Icon	Size	mm	lbs.
267 90		267 06 T6	40	.25
		267 07 T7	40	
		267 08 T8	40	
		267 09 T9	50	
		267 10 T10	50	Each
		267 15 T15	60	\$27.98



**267 92 Set 7 Pcs. TORX® Screwdriver**

Blade high alloy chrome-vanadium-molybdenum steel.

Item	Icon	Size	mm	lbs.
267 92		267 05 T5	40	.27
		267 06 T6	40	
		267 07 T7	40	
		267 08 T8	40	
		267 09 T9	50	
		267 10 T10	50	Each
		267 15 T15	60	\$32.68

**Wiha Precision Accessories & Chip Lifter**



**Lifter Precision Chip Lifter**

Blade chrome-vanadium-molybdenum steel, hardened, chrome-plated. Precision handle high quality plastic, impact resistant.

Item	mm	mm	mm	mm	Inch	lbs.	pkg.	Each
268 10	Standard handle						1	\$4.50
279 20	ESD Safe Conductive handle							\$5.90



**921 90 Master Technicians Bench Top Set**

Plexiglass frame. Equipped with 50 precision drivers.

Item No.	Contents
921 90	Slotted: .8, 1.0, 1.2, 1.5, 1.8, 2.0, 2.5, 3.0, 3.5, 4.0 Phillips: #000, #00, #0, #1 Torx: T1, T2, T3, T4, T5, T6, T7, T8, T9, T10 Metric Hex: 1.3, 1.5, 2.0, 2.5, 3.0 Inch Hex: .028, .035, .050, 1/16, 5/64, 3/32, 7/64, 1/8, 9/64, 5/32"
Each	Metric Nut Drivers: 1.5, 1.8, 2.0, 2.5, 3.0, 3.5, 4.0, 4.5, 5.0, 5.5
\$199.98	26810 Chip Lifter



**260 01 Pocket Clip for Precision Screwdrivers**

Tool clips turn Precision Screwdrivers into Pocket Screwdrivers.

Item	Icon	lbs.	pkg.	Each
260 01		.0035	1	\$30



**260 00 Plastic Precision Tool Rack**

Rack holds 6 precision screwdrivers, can be set on workbench. Also has holes for hanging. Made from high quality plastic.

Item	Icon	lbs.	pkg.	Each
260 00		.08	1	\$2.40



Made in Germany

www.wihatools.com

Wiha Protturn Precision Screwdrivers

# protturn

**Blade**  
chrome-vanadium-molybdenum steel, black finish blades.

**Tapered handle**  
allows rapid rotation.

**Rotating cap**  
for precise turning and control with fingertip.

**Tip**  
precision ground for exact fit.

**Precision handle**  
high quality plastic, cadmium free.

**Molded on ergonomic handle.**

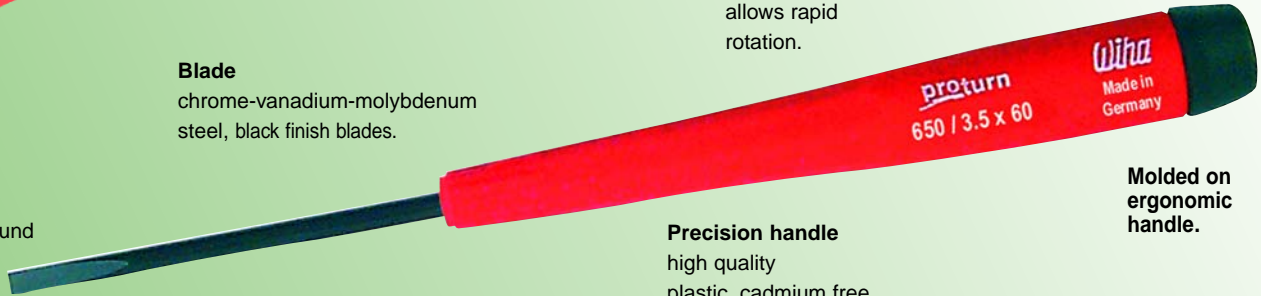

**950 90 Set 6 Pcs. Slotted Protturn Precision**

Molded on precision handle. Blade high alloy chrome-vanadium-molybdenum tool steel, black finish.

Item No.	Size (mm)	Length (mm)	Weight (lbs.)
950 90	1.5	40	.27
	2.0	50	
	2.5	50	
	3.0	60	
	3.5	60	Each
	4.0	60	\$18.50

**951 90 Set 6 Pcs. Slotted/Phillips Protturn Precision**

Molded on precision handle. Blade high alloy chrome-vanadium-molybdenum tool steel, black finish.

Item No.	Bit Type	Size (mm)	Length (mm)	Weight (lbs.)
951 90	Slotted:	1.5mm	40	.27
		2.5mm	50	
		3.5mm	60	
	Phillips:	00	40	
		0	50	Each
		1	60	\$18.98



Made in Germany

Toll Free: (800) 494-6104

Wiha Protturn Precision Series



**953 92 Set 6 Pcs. Metric Hex Protturn Precision**

Molded on precision handle. Blade high alloy chrome-vanadium-molybdenum tool steel, black finish.

Item			
No.	mm	mm	lbs.
<b>953 92</b>	<b>Metric:</b>		
	1.3	40	.29
	1.5	50	
	2.0	50	
	2.5	60	
	3.0	60	Each
	4.0	60	\$16.98



**954 90 Set 8 Pcs. Inch Ball End Protturn Precision**

Molded on precision handle. Blade high alloy chrome-vanadium-molybdenum tool steel, black finish.

Item			
No.	Inch	mm	lbs.
<b>954 90</b>	<b>Inch:</b>		
	.050	40	.39
	1/16	50	
	5/64	50	
	3/32	50	
	7/64	60	
	1/8	60	
	9/64	60	Each
	5/32	60	\$28.98



**953 91 Set 8 Pcs. Inch Hex Protturn Precision**

Molded on precision handle. Blade high alloy chrome-vanadium-molybdenum tool steel, black finish.

Item			
No.	Inch	mm	lbs.
<b>953 91</b>	<b>Inch:</b>		
	.050	40	.29
	1/16	50	
	5/64	50	
	3/32	60	
	7/64	60	
	1/8	60	
	9/64	60	Each
	5/32	60	\$23.98



**668 50 1/4" Bit Holding Screwdriver, With Wiha-Protturn Precision**

Magnetic, holds bit. Shaft chrome-vanadium-molybdenum steel, nickel-plated.

Item								
No.	Size	mm	Inch	mm	Inch	lbs.	pkg.	Each
<b>668 50</b>	1/4"	60	2.36	170	6.7	.07	1	\$6.80



**968 00 Protturn Precision Chip Lifter**

Molded on precision handle. Blade chrome-vanadium-molybdenum tool steel, hardened, black finish.

Item							
No.	Size	mm	mm	Inch	lbs.	pkg.	Each
<b>968 00</b>	1.0	50	145	5.71	.07	1	\$4.88



Made in Germany

www.wihatools.com

Wiha Protturn Precision Series



957 90 Set 6 Pcs. TORX® Protturn

**Precision** Molded on precision handle. Blade high alloy chrome-vanadium-molybdenum tool steel, black finish.

Item No.	Size	mm	lbs.
957 90	T6	40	.25
	T7	40	
	T8	40	
	T9	50	
	T10	50	Each
	T15	60	\$24.98



957 92 Set 7 Pcs. TORX® Cellular Repair Kit

Molded on precision handle. Blade high alloy chrome-vanadium-molybdenum tool steel, black finish.

Item No.	Size	mm	lbs.
957 92	T3	40	.25
	T4	40	
	T5	40	
	T6	40	
	T7	40	Each
	T8	40	\$28.98
	Protturn lifter phone opener		



629 90 Slotted & Phillips Pocket Pack, 5 Pc. Set Wiha Protturn precision ball retainer handle & 4 Wiha interchangeable blades.

629 90 Set includes the following blades:

Slotted: 1.5, 2.0, 3.0, 4.0

Phillips: #000, #00, #0, #1

lbs. .15

Each

\$18.98

629 92 TORX® Pocket Pack, 5 Pc. Set Wiha Protturn precision ball retainer handle & 4 Wiha interchangeable blades.

629 92 Set includes the following blades:

TORX®: T6, T7, T8, T9, T10, T15, T20

lbs. .15

Each

\$19.98



629 93 Slotted/Phillips/TORX® Work Station, 9 Pc. Set Wiha Protturn precision ball retainer handle & 8 Wiha interchangeable blades.

629 93 Set includes the following blades:

Slotted: 1.5, 2.0, 3.0, 4.0

Phillips: #000, #00, #0, #1

TORX®: T6, T7, T8, T9, T10, T15, T20

lbs. .35

Each

\$35.98

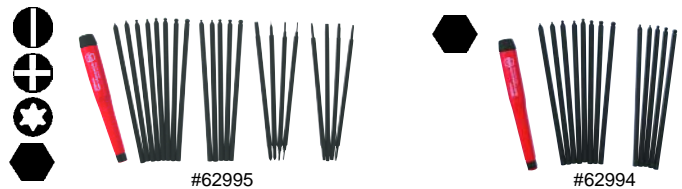

629 95 Slotted/Phillips/TORX®/Ball End Hex Inch & Metric Tech Pack, 22 Pc. Set

Wiha Protturn precision ball retainer handle & 21 Wiha interchangeable blades. Set in canvas storage pouch.

629 95 Set includes the following blades:

Slotted: 1.5, 2.0, 3.0, 4.0

Phillips: #000, #00, #0, #1

TORX®: T6, T7, T8, T9, T10, T15, T20

Hex Inch: .050, 1/16, 5/64, 3/32, 7/64, 1/8, 9/64, 5/32"

Hex Metric: 1.5, 2.0, 2.5, 3.0, 4.0mm

lbs. .87

Each

\$52.70

629 94 Inch/Metric Ball End Hex Work Tech Pack, 14 Pc. Set Wiha Protturn precision ball retainer handle & 13 Wiha interchangeable blades.

629 94 Set includes the following blades:

Hex Inch: .050, 1/16, 5/64, 3/32, 7/64, 1/8, 9/64, 5/32"

Hex Metric: 1.5, 2.0, 2.5, 3.0, 4.0mm

lbs. .66

Set in canvas storage pouch.

Each

\$29.98





Made in Germany

Toll Free: (800) 494-6104



**960 Slotted Screwdriver, With Precision Handle**  
Blade high alloy CVM steel. Single blister package.

Item	↕	↕	↔	↔	↔	↔
No.	mm	Inch	mm	lbs.	pkg.	Each
960 15	1.5	1/16	40	.05	1	\$4.30
960 18	1.8	.070	40	.05	1	\$4.20
960 20	2.0	5/64	40	.05	1	\$3.80
960 25	2.5	3/32	50	.06	1	\$3.80
960 30	3.0	1/8	50	.06	1	\$3.70
960 35	3.5	9/64	60	.08	1	\$4.10
960 40	4.0	5/32	60	.08	1	\$4.20



**961 Phillips Screwdriver, with Precision Handle**  
Blade high alloy CVM steel. Single blister package.

Item	+	↔	↔	↔	
No.	Size	mm	lbs.	pkg.	Each
961 00	00	40	.05	1	\$4.40
961 05	0	50	.07	1	\$4.30
961 10	1	60	.08	1	\$4.20



**963 Hex Metric Screwdriver, Precision Handle**  
Blade high alloy CVM steel. Single blister package.

Item	⬡	↔	↔	↔	
No.	Size	mm	lbs.	pkg.	Each
963 07	.71	40	.052	1	\$4.60
963 09	.89	40	.052	1	\$4.50
963 13	1.3	40	.054	1	\$4.30
963 15	1.5	50	.060	1	\$4.00
963 20	2.0	50	.058	1	\$3.80
963 25	2.5	60	.070	1	\$3.80
963 30	3.0	60	.070	1	\$3.50



**963 Hex Inch Screwdriver, Precision Handle**  
Blade high alloy CVM steel. Single blister package.

Item	⬡	↔	↔	↔	
No.	Size	mm	lbs.	pkg.	Each
963 07	.028	40	.052	1	\$4.60
963 09	.035	40	.052	1	\$4.50
963 13	.050	40	.054	1	\$4.30
963 16	1/16	50	.060	1	\$4.00
963 20	5/64	50	.058	1	\$3.80
963 23	3/32	60	.068	1	\$3.80
963 27	7/64	60	.072	1	\$3.60
963 31	1/8	60	.076	1	\$3.50



**964 Ball End Hex Inch Precision Drivers**  
Blade high alloy chrome-vanadium-molybdenum steel. In single blister package.

Item	⬡	↔	↔	↔	
No.	Size	mm	lbs.	pkg.	Each
964 13	.050	40	.052	1	\$4.50
964 16	1/16	50	.060	1	\$4.40
964 19	5/64	50	.060	1	\$4.40
964 23	3/32	50	.062	1	\$4.40
964 27	7/64	60	.082	1	\$4.40
964 31	1/8	60	.082	1	\$4.50
964 36	9/64	60	.078	1	\$4.60
964 39	5/32	60	.0082	1	\$4.70



**964 Ball End Hex Metric Precision Drivers**  
Blade high alloy chrome-vanadium-molybdenum steel. In single blister package.

Item	⬡	↔	↔	↔	
No.	Size	mm	lbs.	pkg.	Each
964 13	1.3	40	.052	1	\$4.50
964 15	1.5	50	.060	1	\$4.40
964 20	2.0	50	.060	1	\$4.40
964 25	2.5	60	.072	1	\$4.40
964 30	3.0	60	.082	1	\$4.50



**965 Nut Driver Metric Precision Drivers**  
Blade high alloy CVM steel. Single blister package.

Item	○	↔	↔	↔	
No.	Size	mm	lbs.	pkg.	Each
965 10	1.5	60	.056	1	\$4.70
965 15	1.8	60	.064	1	\$4.70
965 20	2.0	60	.064	1	\$4.90
965 25	2.5	60	.074	1	\$4.90
965 30	3.0	60	.076	1	\$5.00
965 32	3.2	60	.074	1	\$5.10
965 35	3.5	60	.078	1	\$5.10
965 40	4.0	60	.078	1	\$5.30
965 45	4.5	60	.080	1	\$5.30
965 50	5.0	60	.080	1	\$5.30
965 55	5.5	60	.090	1	\$5.50
965 60	6.0	60	.092	1	\$5.50
965 70	7.0	60	.096	1	\$5.60



**965 Nut Driver Inch Precision Drivers**  
Blade high alloy CVM steel. Single blister package.

Item	○	↔	↔	↔	
No.	Size	mm	lbs.	pkg.	Each
965 23	3/32	60	.072	1	\$4.90
965 27	7/64	60	.076	1	\$4.90
965 31	1/8	60	.074	1	\$5.10
965 36	9/64	60	.076	1	\$5.10
965 39	5/32	60	.076	1	\$5.30
965 47	3/16	60	.080	1	\$5.30
965 56	7/32	60	.088	1	\$5.50
965 63	1/4	60	.096	1	\$5.50



**967 TORX® Screwdriver, With Precision handle**  
Blade high alloy chrome-vanadium-molybdenum steel. In single blister package.

Item	⬠	↔	↔	↔	
No.	Size	mm	lbs.	pkg.	Each
967 05	T5	40	.05	1	\$5.20
967 06	T6	40	.05	1	\$5.20
967 07	T7	40	.05	1	\$5.20
967 08	T8	40	.06	1	\$5.20
967 09	T9	50	.07	1	\$5.30
967 10	T10	50	.07	1	\$5.50
967 15	T15	60	.08	1	\$5.60
967 20	T20	60	.09	1	\$5.70



Made in Germany

www.wihatools.com

Wiha SYSTEM 4 Precision Handles and Blades

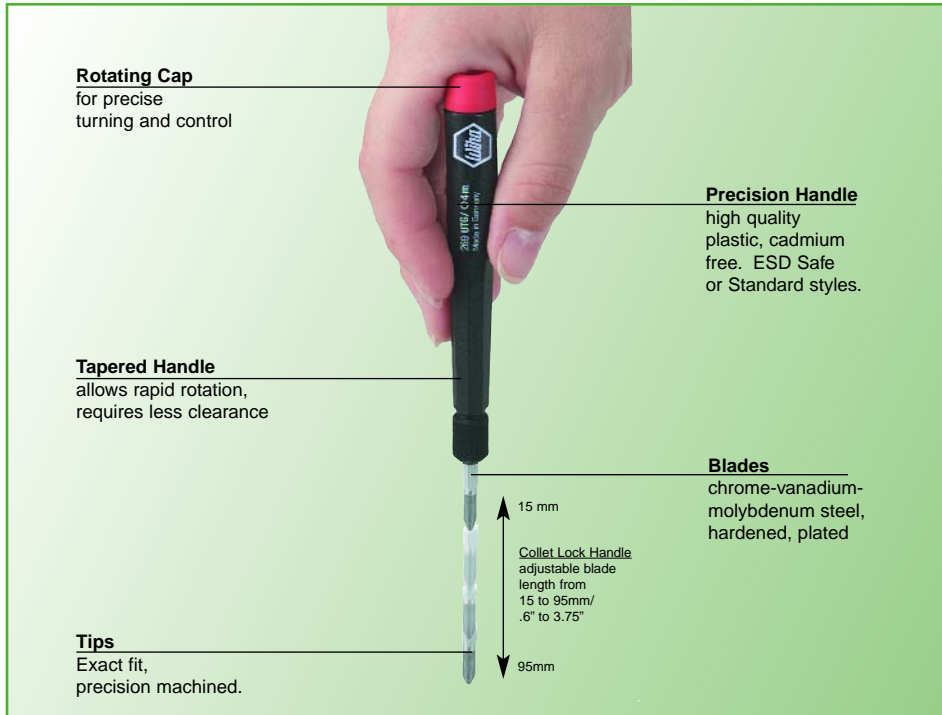

**269 SYSTEM 4 Slotted Reversible Blade**

High alloy chrome-vanadium-molybdenum steel, hardened, chrome-plated, Wiha vapor Chrome-Top finish on tips.

Item	↕	↕	↕	↕	↕	↕
No.	mm	mm	mm	Inch	lbs.	Each
269 03	1.5 + 3.0	120	4.7	.03	\$7.60	
269 04	2.0 + 3.5	120	4.7	.03	\$7.30	
269 05	2.5 + 4.0	120	4.7	.04	\$7.00	



**269 SYSTEM 4 Phillips Reversible Blade**

High alloy CVM steel, hardened, chrome-plated, Wiha vapor Chrome-Top finish on tips.

Item	+	+	↕	↕	↕	↕
No.	Size	Size	mm	Inch	lbs.	Each
269 11	000 + 00	120	4.7	.03	\$7.00	
269 12	0 + 1	120	4.7	.03	\$6.10	



**269 00 SYS 4 Standard Precision Handle,**

with rotating control cap. Accepts all SYSTEM 4 interchangeable blades. Wiha Precision handle, tapered, impact resistant. Ball retainer hold. 110mm/4.3" OAL

Item	↕	↕	+	+	↕	↕
No.	mm	Inch	mm	Inch	lbs.	Each
269 00	4.0	.1574	14.0	.55	.04	\$5.10



**280 00 ESD Safe Conductive Precision Handle**

with rotating control cap. Surface resistant 10<sup>6</sup>-10<sup>9</sup> Ohms. 4 mm hex retainer for all SYSTEM 4 interchangeable blades. Tapered handle, high quality plastic, impact resistant. Ball retainer hold. 110mm/4.3" OAL

Item	↕	↕	+	+	↕	↕
No.	mm	Inch	mm	Inch	lbs.	Each
280 00	4.0	.1574	14.0	.55	.04	\$5.10



**269 SYSTEM 4 Combined Slotted/Phillips Reversible Blade**

High alloy CVM steel, hardened, chrome-plated, Wiha vapor Chrome-Top finish on tips.

Item	↕	+	↕	↕	↕	↕
No.	mm	Size	mm	Inch	lbs.	Each
269 71	1.5+	000	120	4.7	.03	\$7.70
269 72	2.0+	00	120	4.7	.03	\$7.30
269 73	3.0+	0	120	4.7	.03	\$6.60
269 74	4.0+	1	120	4.7	.04	\$6.60



**269 01 SYSTEM 4 Standard Precision Adjustable handle**

with rotating control cap. Advantages:

- Allows adjustable blade from 15 to 95mm.
- Collet lock allows for quick & easy adjustment.
- Holds blade securely in place. Accepts all SYSTEM 4 blades. 110mm/4.3" OAL

Item	↕	↕	+	+	↕	↕
No.	mm	Inch	mm	Inch	lbs.	Each
269 01	4.0	.1574	14.0	.55	.04	\$5.90



**280 01 ESD Safe Conductive Precision Adjustable Handle**

with rotating control cap. Advantages:

- Use in ESD sensitive applications. Surface resistant 10<sup>6</sup>-10<sup>9</sup> Ohms.
- Collet lock allows for quick & easy adjustment.
- Holds blade securely in place. Accepts all SYSTEM 4 blades. 110mm/4.3" OAL

Item	↕	↕	+	+	↕	↕
No.	mm	Inch	mm	Inch	lbs.	Each
280 01	4.0	.1574	14.0	.55	.04	\$5.90



**269 SYSTEM 4 Pozidriv® Reversible Blade**

High alloy chrome-vanadium-molybdenum steel, hardened, chrome-plated, Wiha vapor Chrome-Top finish on tips.

Item	+	+	↕	↕	↕	↕
No.	Size	Size	mm	Inch	lbs.	Each
269 22	0 + 1	120	4.7	.03	\$6.20	



Made in Germany

Toll Free: (800) 494-6104

Wiha SYSTEM 4 Precision Blades



**269 SYSTEM 4 Metric Ball End & Standard Hex, Reversible Blade** CVM steel, hardened, chrome-plated, Wiha vapor Chrome-Top finish on tips. One side hex, other side ballpoint hex.

Item						
No.	Size	Size	mm	Inch	lbs.	Each
269 32	1.3 + 1.3	120	4.7	.05	\$6.52	
269 33	1.5 + 1.5	120	4.7	.06	\$6.52	
269 34	2.0 + 2.0	120	4.7	.06	\$6.32	
269 35	2.5 + 2.5	120	4.7	.06	\$6.12	
269 36	3.0 + 3.0	120	4.7	.06	\$5.92	
269 37	4.0 + 4.0	120	4.7	.06	\$5.92	



**280 SYSTEM 4 Metric Ball End Hex Interchangeable Blade** High alloy tool steel, hardened, corrosion protected. Ballpoint end works at 30° angle entry for easy access to fasteners.

Item						
No.	Size	mm	Inch	lbs.	pkg.	Each
280 33	1.5	120	4.7	.05	1	\$3.00
280 34	2.0	120	4.7	.05	1	\$3.00
280 35	2.5	120	4.7	.06	1	\$3.00
280 36	3.0	120	4.7	.06	1	\$3.00
280 37	4.0	120	4.7	.06	1	\$3.00



**280 SYSTEM 4 Inch Ball End Hex Interchangeable Blade** High alloy tool steel, hardened, corrosion protected. Ballpoint end works at 30° angle entry for easy access to fasteners.

Item					
No.	Size	mm	Inch	lbs.	Each
280 21	.050	120	4.7	.06	\$3.00
280 23	1/16	120	4.7	.06	\$3.00
280 24	5/64	120	4.7	.06	\$3.00
280 25	3/32	120	4.7	.06	\$3.00
280 26	7/64	120	4.7	.06	\$3.00
280 27	1/8	120	4.7	.06	\$3.00
280 28	9/64	120	4.7	.06	\$3.00
280 29	5/32	120	4.7	.06	\$3.00



**269 SYSTEM 4 Metric Hex Sizes, Interchangeable Blade** High alloy CVM steel, hardened, corrosion protected.

Item					
No.	Size	mm	Inch	lbs.	Each
269 13	0.7	120	4.7	.06	\$3.68
269 14	0.9	120	4.7	.06	\$3.68
269 15	1.3	120	4.7	.06	\$3.50
269 16	1.5	120	4.7	.06	\$3.50
269 17	2.0	120	4.7	.06	\$3.50
269 18	2.5	120	4.7	.06	\$3.50
269 19	3.0	120	4.7	.06	\$3.08
269 20	4.0	120	4.7	.06	\$3.08



**269 SYSTEM 4 Inch Hex Sizes, Interchangeable Blade** High alloy chrome-vanadium-molybdenum steel, hardened, corrosion protected.

Item					
No.	Size	mm	Inch	lbs.	Each
269 21	.050	120	4.7	.06	\$4.10
269 23	1/16	120	4.7	.06	\$4.10
269 24	5/64	120	4.7	.06	\$3.90
269 25	3/32	120	4.7	.06	\$3.90
269 26	7/64	120	4.7	.06	\$3.90
269 27	1/8	120	4.7	.06	\$3.90
269 28	9/64	120	4.7	.06	\$3.50
269 29	5/32	120	4.7	.06	\$3.50



**269 SYSTEM 4 Nut Driver Inch, Interchangeable Blade.** High alloy chrome-vanadium-molybdenum steel, hardened, corrosion protected. 120mm/4.7" OAL

Item					
No.	Size	Inch	Inch	lbs.	Each
269 62	3/32	.16	.16	.04	\$5.40
269 63	7/64	.20	.20	.04	\$5.60
269 64	1/8	.20	.20	.04	\$5.90
269 65	9/64	.21	.24	.04	\$5.90
269 66	5/32	.22	.24	.04	\$5.90
269 67	3/16	.26	.28	.04	\$6.70
269 68	7/32	.30	.32	.04	\$6.70
269 69	1/4	1.34	.36	.04	\$6.70



**269 SYSTEM 4 TORX® Reversible Blade** High alloy chrome-vanadium-molybdenum steel, hardened, vapor chrome protected, Wiha vapor Chrome-Top finish on tips. 120mm/4.7" OAL.

Item				
No.	Size	Size	lbs.	Each
269 51	T6 + T8	.03	\$5.60	
269 52	T7 + T9	.03	\$5.60	
269 53	T10 + T15	.03	\$5.60	
269 54	T15 + T20	.03	\$5.60	



**269 SYSTEM 4 TORX® Interchangeable Blade** High alloy CVM steel, hardened, Wiha vapor Chrome-Top finish on tips. 120mm/4.7" OAL

Item			
No.	Size	lbs.	Each
269 55	T3	.03	\$5.60
269 56	T4	.03	\$5.60
269 57	T5	.03	\$5.60



**269 SYSTEM 4 Nut Driver Metric, Interchangeable Blade** High alloy chrome-vanadium-molybdenum steel, hardened, corrosion protected. 120mm/4.7" OAL

Item						
No.	Size	Size	Inch	Inch	lbs.	Each
269 40	1.5 + 1.8	.12	.12	.03	\$8.90	
269 41	2.0 + 2.5	.16	.16	.03	\$8.90	
269 38	1.5 -	.11	.11	.04	\$5.40	
269 39	1.8 -	.12	.12	.04	\$5.40	
269 49	2.0 -	.13	.13	.04	\$5.40	
269 50	2.5 -	.16	.16	.04	\$6.00	
269 42	3.0 -	.20	.20	.04	\$6.20	
269 43	3.2 -	.20	.20	.04	\$6.40	
269 44	3.5 -	.22	.24	.04	\$6.40	
269 45	4.0 -	.22	.24	.04	\$6.60	
269 46	4.5 -	.25	.28	.05	\$6.60	
269 47	5.0 -	.27	.28	.05	\$6.60	
269 48	5.5 -	.30	.32	.05	\$6.90	



Made in Germany

www.wihatools.com

**Wiha Canvas Pouch Sets**

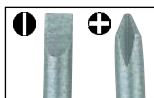

Canvas Pouch

**269 90 Slotted & Phillips Precision Interchangeable Blade Set, 4 Pcs.** Wiha ESD Safe precision collet lock handle and 3 Wiha interchangeable blades.  
**269 90 Set includes the following blades:**  
 † **Slotted Sizes:** 2.0, 3.0, 4.0mm  
 † **Phillips Sizes:** 00, 0, 1 Each  
 ⚖ **lbs.** .19 \$28.58



Canvas Pouch

**280 80 Slotted, Phillips TORX® & Hex Precision Interchangeable Blade Set, 22 Pcs.** Wiha ESD Safe precision collet lock handle and 20 Wiha interchangeable blades.  
**280 80 Set includes the following blades:**  
 † **Slotted Sizes:** 1.5, 2.0, 3.0, 4.0mm  
 † **Phillips Sizes:** 000, 00, 0, 1  
 † **Torx Sizes:** T3, T4, T5, T6, T7, T8, T9, T10, T15  
 † **Hex Sizes:** .028, .035  
 † **Ball Hex Sizes:** .050, 1/16, 5/64, 3/32, 7/64, 1/8, 9/64, 5/32"  
**Protturn Chip Lifter - #96800** Each  
 ⚖ **lbs.** .33 \$81.60

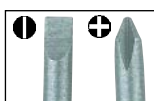

Canvas Pouch

**269 91 Slotted & Phillips Precision Interchangeable Blade Set, 6 Pcs.** Wiha ESD Safe precision collet lock handle and 5 Wiha interchangeable blades. In canvas pouch.  
**269 91 Set includes the following blades:**  
 † **Slotted Sizes:** 1.5, 2.0, 2.5, 3.0, 3.5, 4.0mm  
 † **Phillips Sizes:** 000, 00, 0, 1 Each  
 ⚖ **lbs.** .29 \$43.98



**ESD Technicians Kit  
Precision Screwdrivers & Tweezers**

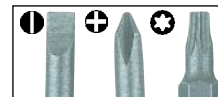

Canvas Pouch

**445 90 Slotted, Phillips and TORX® Precision Interchangeable Blade Set, 12 Pcs.** Wiha ESD Safe precision collet lock handle, 7 Wiha interchangeable blades and 4 ESD Safe Tweezers.  
**445 90 Set includes the following blades:**  
 † **Slotted Sizes:** 2.0, 3.0, 4.0mm  
 † **Phillips Sizes:** 00, 0, 1  
 † **Torx Sizes:** T6, T7, T8, T9, T10, T15  
**ESD Safe Precision Tweezers:**  
 44501 Fine Point - AA SA  
 44509 Extra Fine Point - 5 SA  
 44505 Flat and Blunt - 2a SA  
 44510 Curved Fine Point - 7a SA Each  
 ⚖ **lbs.** .60 \$99.98



**Slotted, Phillips, Hex Set In Canvas Pouch**

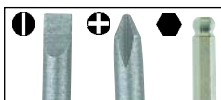

Canvas Pouch

**269 92 Slotted, Phillips and Ball End Hex Metric/Inch Precision Interchangeable Blade Set, 17 Pcs.** Wiha ESD Safe precision collet lock handle and 15 Wiha interchangeable blades.  
**269 92 Sets include the following blades:**  
 † **Slotted Sizes:** 1.5, 2.0, 3.0, 4.0mm  
 † **Phillips Sizes:** 000, 00, 0, 1  
 † **Ball End Hex Inch:** .050, 1/16, 5/64, 7/64, 3/32, 1/8"  
 † **Ball End Hex Metric:** 1.5, 2.0, 2.5, 3.0, 4.0mm  
**Protturn Chip Lifter - #96800**  
 ⚖ **lbs.** .63 Each \$69.98





Made in Germany

Toll Free: (800) 494-6104

**ESD Anti-Static Vinyl Pouch Set**

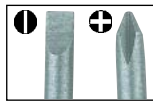

**280 91 Slotted & Phillips Precision Interchangeable Blade Set, 6 Pcs.** Wiha-ESD Safe precision collet lock handle and 5 Wiha interchangeable blades.

**280 91 Set includes the following blades:**  
 ↓ **Slotted Sizes:** 1.5, 2.0, 2.5, 3.0, 3.5, 4.0mm  
**Phillips Sizes:** 000, 00, 0, 1 **Each**  
**lbs.** .25 **\$38.70**



**TORX® Set**



**280 87 TORX® Precision Interchangeable Blade Set, 8 Pcs.** Wiha-ESD Safe precision collet lock handle and 7 Wiha interchangeable blades.

**280 87 Set includes the following blades:**  
**TORX® Sizes on standard blades:** T3, T4, T5  
**TORX® Sizes on reversible blades:** T6, T7, T8, T9, T10, T15, T20  
**lbs.** .31 **Each \$38.98**



**Slotted, Phillips, TORX® Set**



**280 97 Slotted, Phillips and TORX® Precision Interchangeable Blade Set, 9 Pcs.** Wiha ESD Safe precision collet lock handle and 8 Wiha interchangeable blades.

**280 97 Set includes the following blades:**  
 ↓ **Slotted Sizes:** 1.5, 2.0, 3.0, 4.0mm  
**Phillips Sizes:** 000, 00, 0, 1  
**Torx Sizes:** T5, T6, T7, T8, T9, T10, T15  
**lbs.** .33 **Each \$49.98**



**Nut Driver Sets**



**280 88 Nut Driver Inch Precision Blade Set, 9 pcs.** Wiha ESD Safe precision collet lock handle and 8 Wiha interchangeable blades.

**280 88 Set includes the following blades:**  
**Nut driver Inch Sizes:** 3/32, 7/64, 1/8, 9/64, 5/32, 3/16, 7/32, 1/4"  
**lbs.** .37 **Each \$49.60**



**280 84 Slotted, Phillips and Ball End Hex Inch Precision Interchangeable Blade Set, 13 Pcs.** Wiha ESD Safe precision collet lock handle and 12 Wiha interchangeable blades.

**280 84 Set includes the following blades:**  
 ↓ **Slotted Sizes:** 1.5, 2.0, 3.0, 4.0mm  
**Phillips Sizes:** 000, 00, 0, 1  
**Ball End Hex Inch Sizes:** .050, 1/16, 5/64, 3/32, 7/64, 1/8, 9/64, 5/32"  
**lbs.** .43 **Each \$44.98**



**280 98 Nut Driver Metric Precision Blade Set, 8 Pcs.** Wiha ESD Safe precision collet lock handle and 7 Wiha interchangeable blades.

**280 98 Set includes the following blades:**  
**Nut driver Metric Sizes:** 3.0, 3.2, 3.5, 4.0, 4.5, 5.0, 5.5mm  
**lbs.** .40 **Each \$47.98**



**Slotted, Phillips, Torx® Set In Steel Box**



**280 94 Slotted, Phillips & Torx® Precision Interchangeable Blade Set, 11 Pcs.** Wiha ESD Safe precision collet lock handle and 10 Wiha interchangeable blades.

**280 94 Set includes the following blades:**  
 ↓ **Slotted Sizes:** 1.5, 2.0, 3.0, 4.0mm  
**Phillips Sizes:** 000, 00, 0, 1  
**Torx®:** T3, T4, T5, T6, T7, T8, T9, T10, T15  
**lbs.** 1.51 **Each \$71.38**



**Slotted & Phillips Set**

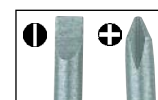

**269 93 Slotted & Phillips Precision Interchangeable Blade Set, 6 Pcs.** Wiha ESD Safe precision collet lock handle and 5 Wiha interchangeable blades.

**269 93 Set includes the following blades:**  
 ↓ **Slotted Sizes:** 1.5, 2.0, 2.5, 3.0, 3.5, 4.0mm  
**Phillips Sizes:** 000, 00, 0, 1 **Each**  
**lbs.** .94 **\$49.98**





Wiha SYSTEM 4 Sets in Compact Fold-out box

Slotted, Phillips, TORX® Sets



**269 96 Slotted & Phillips Precision Interchangeable Blade Set, 5 Pcs.** Wiha ESD Safe precision collet lock handle and 4 Wiha interchangeable blades.

**269 96 Set includes the following reversible blades in Slotted/Phillips sizes:**

**Slotted Sizes:** 1.5, 2.0, 3.0, 3.5mm

**Phillips Sizes:** 000, 00, 0, 1

lbs. .24 Each \$32.00



Nut Driver Sets



**269 88 Nut Driver Inch Precision Blade Set, 9 Pcs.** Wiha ESD Safe precision collet lock handle & 8 Wiha interchangeable blades.

**269 88 Set includes the following blades:**

**Nut driver Inch Sizes:**

3/32, 7/64, 1/8, 9/64, 5/32,

3/16, 7/32, 1/4"

lbs. .38 Each \$49.60



**269 97 Slotted, Phillips and TORX® Precision Interchangeable Blade Set, 9 Pcs.** Wiha ESD Safe Precision Collet Lock handle and 8 Wiha Interchangeable blades.

**269 97 Set includes the following blades:**

**Slotted Sizes:** 1.5, 2.0, 2.5, 3.0, 3.5, 4.0mm

**Phillips Sizes:** 000, 00, 0, 1

**TORX® Sizes:** T6, T7, T8, T9, T10, T15

lbs. .34 Each \$53.40



**269 98 Nut Driver Metric Precision Blade Set, 9 Pcs.** Wiha ESD Safe precision collet lock handle and 8 Wiha interchangeable blades.

**269 98 Set includes the following blades:**

**Nut driver Metric Sizes:**

2.0, 2.5, 3.0, 3.2, 3.5, 4.0,

4.5, 5.0, 5.5mm

lbs. .40 Each \$58.98



TORX® Sets



**269 99 Hex Metric Precision Blade Set, 9 Pcs.** Wiha ESD Safe Precision Collet Lock handle and 8 Wiha interchangeable blades.

**269 99 Set includes the following blades:**

**Hex Metric Sizes:** 0.7, 0.9, 1.3, 1.5, 2.0, 2.5, 3.0, 4.0mm

lbs. .36 Each \$32.52



**269 95 TORX® Precision Interchangeable Blade Set, 5 Pcs.** Wiha ESD Safe precision collet lock handle & 4 interchangeable blades.

**269 95 Set includes the following blades:**

**TORX® Sizes:**

T6, T7, T8, T9, T10, T15, T20

lbs. .24 Each \$25.90



**269 89 Hex Inch Precision Blade Set, 9 Pcs.** Wiha ESD Safe Precision Collet Lock handle and 8 Wiha interchangeable blades.

**269 89 Set includes the following blades:**

**Hex Inch Sizes:** .050, 1/16, 5/64, 3/32, 7/64, 1/8, 9/64, 5/32"

lbs. .35 Each \$32.52



**269 87 TORX® Precision Interchangeable Blade Set, 8 Pcs.** Wiha ESD Safe precision collet lock handle and 7 interchangeable blades.

**269 87 Set includes the following blades:**

**TORX® Sizes on standard blades:**

T3, T4, T5

**TORX® Sizes on reversible blades:**

T6, T7, T8, T9, T10, T15, T20

lbs. .33 Each \$38.76





Made in Germany

Toll Free: (800) 494-6104

Wiha SYSTEM 4 Micro Bits

SYSTEM 4 Handles and Micro Bits

**Precision Handle**  
high quality plastic, cadmium free. ESD Safe or Standard Styles

**Tapered Handle**  
allows rapid rotation, requires less clearance

**Tips**  
Exact fit, precision machined

**Rotating Cap**  
for precise turning and control

**Collet Lock Handle**  
adjustable blade length from 15 to 95mm/.6" to 3.75"

**Bits**  
chrome-vanadium-molybdenum steel, hardened, plated



**758 00 SYSTEM 4 Standard Precision Bit**

**Handle** with rotating control cap. Wiha Precision handle, tapered, high quality plastic, impact resistant, ball retainer. Accepts all SYSTEM 4 Series bits. 110mm/4.3" OAL

Item	○	○	+	+	⌘	⌘
No.	mm	Inch	mm	Inch	lbs.	Each
758 00	4.0	.1574	14.0	.55	.06	\$4.40



**750 SYSTEM 4 Slotted Bits** High alloy CVM steel, hardened, on 4 mm hex stock.

Item	⬇	⬇	⬇	⌘	⌘
No.	mm	mm	Inch	lbs.	Each
750 08	0.8	28	1.1	.007	\$1.98
750 12	1.2	28	1.1	.007	\$1.98
750 15	1.5	28	1.1	.007	\$1.98
750 18	1.8	28	1.1	.007	\$1.98
750 20	2.0	28	1.1	.007	\$1.98
750 25	2.5	28	1.1	.007	\$1.98
750 30	3.0	28	1.1	.007	\$1.98
750 35	3.5	28	1.1	.007	\$1.98
750 40	4.0	28	1.1	.007	\$1.98



**758 01 SYSTEM 4 ESD Safe Conductive Precision Bit Handle**

with rotating control cap. Wiha precision handle, tapered, high quality plastic, impact resistant.

**Advantages:**

- For working in ESD sensitive applications. Surface resistant 10<sup>6</sup>-10<sup>9</sup> Ohms.
- Ball retainer holds bits securely in place.
- Accepts all SYSTEM 4 Series bits.
- 110mm/4.3" OAL

Item	○	○	+	+	⌘	⌘
No.	mm	Inch	mm	Inch	lbs.	Each
758 01	4.0	.1574	14.0	.55	.06	\$4.40



**751 SYSTEM 4 Phillips Bits**

High alloy chrome-vanadium-molybdenum steel, hardened, on 4 mm hex stock.

Item	+	+	+	⌘	⌘
No.	Size	mm	Inch	lbs.	Each
751 05	000	28	1.1	.007	\$1.98
751 10	00	28	1.1	.007	\$1.98
751 15	0	28	1.1	.007	\$1.98
751 20	1	28	1.1	.007	\$1.98



**753 SYSTEM 4 Hex Metric Bits** High alloy CVM steel, hardened, on 4 mm hex stock.

Item	⬇	⬇	⬇	⌘	⌘
No.	mm	mm	Inch	lbs.	Each
753 07	0.7	28	1.1	.007	\$1.98
753 09	0.9	28	1.1	.007	\$1.98
753 13	1.3	28	1.1	.007	\$1.98
753 15	1.5	28	1.1	.007	\$1.98
753 20	2.0	28	1.1	.007	\$1.98
753 25	2.5	28	1.1	.007	\$1.98
753 30	3.0	28	1.1	.007	\$1.98
753 40	4.0	28	1.1	.007	\$1.98



**753 SYSTEM 4 Hex Inch Bits**

High alloy chrome-vanadium-molybdenum steel, hardened, on 4 mm hex stock.

Item	⬇	⬇	⬇	⌘	⌘
No.	Inch	mm	Inch	lbs.	Each
753 07	.028	28	1.1	.007	\$1.98
753 09	.035	28	1.1	.007	\$1.98
753 13	.050	28	1.1	.007	\$1.98
753 50	1/16	28	1.1	.007	\$1.98
753 52	5/64	28	1.1	.007	\$1.98
753 54	3/32	28	1.1	.007	\$1.98
753 56	7/64	28	1.1	.007	\$1.98
753 58	1/8	28	1.1	.007	\$1.98
753 60	9/64	28	1.1	.007	\$1.98
753 40	5/32	28	1.1	.007	\$1.98



**753 SYSTEM 4 Metric Tamper Resistant Hex Bits** High alloy CVM steel, hardened, on 4 mm hex stock.

Item	⬇	⬇	⬇	⌘	⌘
No.	mm	mm	Inch	lbs.	Each
753 22	2.0	28	1.1	.007	\$2.20
753 27	2.5	28	1.1	.007	\$2.20
753 32	3.0	28	1.1	.007	\$2.20
753 42	4.0	28	1.1	.007	\$2.20



**753 SYSTEM 4 Tamper Resistant Hex Inch Bits** High alloy CVM steel, hardened, on 4 mm hex stock.

Item	⬇	⬇	⬇	⌘	⌘
No.	Inch	mm	Inch	lbs.	Each
753 62	5/64	28	1.1	.007	\$2.20
753 64	3/32	28	1.1	.007	\$2.20
753 66	7/64	28	1.1	.007	\$2.20
753 68	1/8	28	1.1	.007	\$2.20
753 70	9/64	28	1.1	.007	\$2.20
753 72	5/32	28	1.1	.007	\$2.20



Made in Germany

www.wihatools.com

**Wiha SYSTEM 4 Micro Bits**



**757 SYSTEM 4 TORX® Bits**

High alloy chrome-vanadium-molybdenum steel, hardened, on 4 mm stock.

Item					
No.	Size	mm	Inch	lbs.	Each
757 03	T3	28	1.1	.007	\$1.98
757 04	T4	28	1.1	.007	\$1.98
757 05	T5	28	1.1	.007	\$1.98
757 06	T6	28	1.1	.007	\$1.98
757 07	T7	28	1.1	.007	\$1.98
757 08	T8	28	1.1	.007	\$1.98
757 09	T9	28	1.1	.007	\$1.98
757 10	T10	28	1.1	.007	\$1.98
757 15	T15	28	1.1	.007	\$1.98
757 20	T20	28	1.1	.007	\$1.98



**757 SYSTEM 4 TORX® Tamper Resistant Bits**

High alloy CVM steel, hardened, on 4 mm stock.

Item					
No.	Size	mm	Inch	lbs.	Each
757 27	TR7	28	1.1	.007	\$2.20
757 28	TR8	28	1.1	.007	\$2.20
757 29	TR9	28	1.1	.007	\$2.20
757 35	TR10	28	1.1	.007	\$2.20
757 39	TR15	28	1.1	.007	\$2.20
757 42	TR20	28	1.1	.007	\$2.20



**759 00 Extension blade for SYSTEM 4 Micro Bits.**

Shaft CVM steel, hardened, corrosion protected. Ball retainer bit extension for 4 mm bits.

Item					
No.	Size	mm	mm	lbs.	Each
759 00	4.0	105	4.0	.07	\$5.10



**759 01 Magnetic Bit extension blade for SYSTEM 4 Micro Bits.**

Shaft Chrome-vanadium-molybdenum steel, hardened, corrosion protected. Magnetic bit holder.

Item					
No.	Size	mm	mm	lbs.	Each
759 01	4.0	105	4.0	.04	\$6.10

Wiha Micro Bits are Made in Germany or USA

**759 99 SYSTEM 4 Slotted, Phillips, Hex Inch & Metric Precision Interchangeable Bit Set, 26 Pcs. In Compact Fold Out Box.**

Wiha precision handle, bit extension & 24 interchangeable bits.



**Item No. Combination Bit Set**

759 99 Set with Standard Precision Handle

Sets include the following bits:

Slotted: 1.5, 2.0, 3.0, 4.0mm

Phillips: 000, 00, 0, 1

Hex Metric: .7, .9, 1.3, 1.5, 2.0, 2.5, 3.0, 4.0mm

Hex Inch: .050, 1/16, 5/64, 3/32, 7/64, 1/8, 9/64, 5/32"

105mm Bit Extension

lbs. .34 **Each \$46.68**



26 Pc. Set

**753 SYSTEM 4 Hex Inch & Metric Precision Interchangeable Bit Set, 18 Pcs. In Compact Fold Out Box.**

Wiha precision handle, bit extension and 16 Wiha interchangeable bits.



**Item No. Combination Bit Set**

753 95 Set with Standard Precision Handle &

753 96 Set with ESD Safe Precision Handle

Sets include the following bits:

Hex Metric: .7, .9, 1.3, 1.5, 2.0, 2.5, 3.0, 4.0mm

Hex Inch: .050, 1/16, 5/64, 3/32, 7/64, 1/8, 9/64, 5/32"

105mm Bit Extension

lbs. .31 **Each \$31.98**



18 Pc. Set

**757 93 SYSTEM 4 TORX® & Hex Inch/ Metric Precision Interchangeable Bit Set, 26 Pcs. In Compact Fold Out Box.**

Wiha standard precision handle, bit extension & 24 interchangeable bits.



**Item No. Combination Bit Set**

757 93 Set with Standard Precision Handle

Sets include the following bits:

Hex Metric: .7, .9, 1.3, 1.5, 2.0, 2.5, 3.0, 4.0mm

Hex Inch: .050, 1/16, 5/64, 3/32, 7/64, 1/8, 9/64, 5/32"

TORX®: T4, T5, T6, T7, T8, T9, T10, T15

105mm Bit Extension

lbs. .35 **Each \$47.98**



26 Pc. Set





Made in Germany

Toll Free: (800) 494-6104

**Wiha SYS 4 Micro Bits & Compact Bit Sets**

**757 sets** SYSTEM 4 **TORX®** Precision Interchangeable Bit Set, 11 Pcs. In Compact Fold Out Box. Sets include your choice of Wiha precision handle, bit extension and 9 Wiha interchangeable bits.

Item No.	Handle Options for SYSTEM 4
757 91	Set with Standard Precision Handle
757 92	Set with ESD Safe Precision Handle
<b>Sets include the following bits:</b>	
<ul style="list-style-type: none"> <li><b>TORX® Sizes:</b> T3, T4, T5, T6, T7, T8, T9, T10, T15</li> <li><b>105mm Bit Extension</b></li> </ul>	
<p>lbs. .26      Each \$27.50</p>	



11 Pc. Set

**759 sets** SYSTEM 4 Slotted/Phillips/Hex Inch/**TORX®** Precision Interchangeable Bit Set, 27 Pcs. In Compact Fold Out Box. Sets include your choice of Wiha precision handle, bit extension and 25 Wiha interchangeable bits.

Item No.	Handle Options for SYSTEM 4
759 91	Set with Standard Precision Handle
759 92	Set with ESD Safe Precision Handle
<b>Sets include the following bits:</b>	
<ul style="list-style-type: none"> <li><b>Slotted Sizes:</b> 1.5, 2.0, 3.0, 4.0mm</li> <li><b>Phillips Sizes:</b> 000, 00, 0, 1</li> <li><b>TORX® Sizes:</b> T3, T4, T5, T6, T7, T8, T9, T10, T15</li> <li><b>Hex Inch Sizes:</b> .050, 1/16, 5/64, 3/32, 7/64, 1/8, 9/64, 5/32"</li> <li><b>105mm Bit Extension</b></li> </ul>	
<p>lbs. .34      Each \$49.98</p>	



27 Pc. Set

**759 sets** SYSTEM 4 Slotted/Phillips/Hex Metric/**TORX®** Precision Interchangeable Bit Set, 27 Pcs. In Compact Fold Out Box. Sets include your choice of Wiha precision handle, bit extension and 25 Wiha interchangeable bits.

Item No.	Handle Options for SYSTEM 4
759 93	Set with Standard Precision Handle
759 94	Set with ESD Safe Precision Handle
<b>Sets include the following bits:</b>	
<ul style="list-style-type: none"> <li><b>Slotted Sizes:</b> 1.5, 2.0, 3.0, 4.0mm</li> <li><b>Phillips Sizes:</b> 000, 00, 0, 1</li> <li><b>TORX® Sizes:</b> T3, T4, T5, T6, T7, T8, T9, T10, T15</li> <li><b>Hex Metric Sizes:</b> .7, .9, 1.3, 1.5, 2.0, 2.5, 3.0, 4.0mm</li> <li><b>105mm Bit Extension</b></li> </ul>	
<p>lbs. .26      Each \$49.98</p>	



27 Pc. Set

**759 sets** SYSTEM 4 Slotted/Phillips/Hex Metric/Hex Inch/**TORX®** Precision Interchangeable Bit Set, 40 Pcs. In Steel Box Case. Sets include your choice of Wiha precision handle, bit extension & 38 interchangeable bits.

Item No.	Handle Options for SYSTEM 4
759 95	Set with Standard Precision Handle
759 96	Set with ESD Safe Precision Handle
<b>Sets include the following bits:</b>	
<ul style="list-style-type: none"> <li><b>Slotted Sizes:</b> 0.8, 1.2, 1.5, 1.8, 2.0, 2.5, 3.0, 3.5, 4.0mm</li> <li><b>Phillips Sizes:</b> 000, 00, 0, 1</li> <li><b>TORX® Sizes:</b> T3, T4, T5, T6, T7, T8, T9, T10, T15</li> <li><b>Hex Metric Sizes:</b> .7, .9, 1.3, 1.5, 2.0, 2.5, 3.0, 4.0mm</li> <li><b>Hex Inch Sizes:</b> .050, 1/16, 5/64, 3/32, 7/64, 1/8, 9/64, 5/32</li> <li><b>105mm Bit Extension</b></li> </ul>	
<p>lbs. 1.04      Each \$79.98</p>	

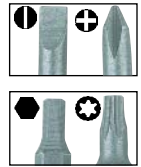

40 Pc. Set



SYSTEM 4 Micro Bit Sets

**759 sets** SYSTEM 4 Standard & Tamper Resistant Hex and **TORX®** and Tamper Resistant **TORX®** Precision Interchangeable Bit Set, 25 Pcs. In Compact Fold Out Box. Sets include your choice of Wiha precision handle, bit extension and 23 Wiha interchangeable bits.

Item No.	Handle Options for SYSTEM 4
759 97	Set with Standard Precision Handle
759 98	Set with ESD Safe Precision Handle
<b>Sets include the following bits:</b>	
<ul style="list-style-type: none"> <li><b>Standard Metric Hex:</b> 1.5mm</li> <li><b>Tamper Resistant Metric Hex:</b> 2.0, 2.5, 3.0, 4.0mm</li> <li><b>Standard Inch Hex:</b> .050, 1/16"</li> <li><b>Tamper Resistant Inch Hex:</b> 5/64, 3/32, 7/64, 1/8, 9/64, 5/32"</li> <li><b>Standard TORX® Sizes:</b> T3, T4, T5, T6</li> <li><b>Tamper Resistant TORX® Sizes:</b> TR7, TR8, TR9, TR10, TR15, TR20</li> <li><b>105mm Bit Extension</b></li> </ul>	
<p>lbs. .34      Each \$45.36</p>	

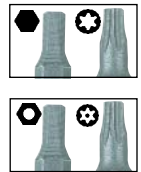

25 Pc. Set





Made in Germany

Toll Free: (800) 494-6104

# Professional Quality ESD Tweezers

ESD SAFE • ANTI STATIC CONDUCTIVE • HYPO ALLERGENIC COATED • TEXTURED GRIPPING SURFACE

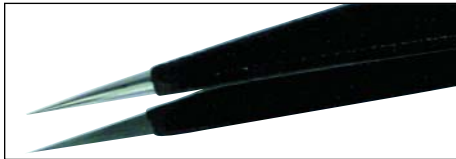

## Universal Fine Point Tweezer

Item No.	Description	wt.	Each
445 01	AA SA ESD - 130mm	.088	\$13.18

Anti-static conductive, ESD Safe hypo allergenic tweezers made from Vommeloy. Special stainless steel, anti-magnetic and acid resistant.

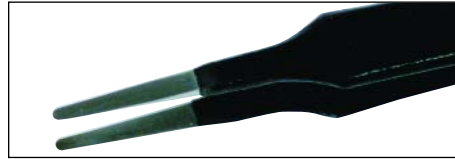

## Flat Round Tip Smooth Sides

Item No.	Description	wt.	Each
445 05	2a SA ESD - 120mm	.082	\$16.60

Anti-static conductive, ESD Safe hypo allergenic tweezers made from Vommeloy. Special stainless steel, anti-magnetic and acid resistant.

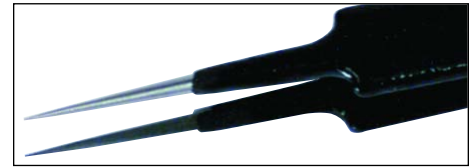

## Extra Fine Points/Tapered To Tip

Item No.	Description	wt.	Each
445 09	5 SA ESD - 110mm	.076	\$17.40

Anti-static conductive, ESD Safe hypo allergenic tweezers made from Vommeloy. Special stainless steel, anti-magnetic and acid resistant.

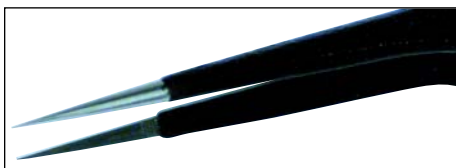

## Sturdy Long, Fine Round Points

Item No.	Description	wt.	Each
445 02	GG SA ESD - 130mm	.092	\$17.40

Anti-static conductive, ESD Safe hypo allergenic tweezers made from Vommeloy. Special stainless steel, anti-magnetic and acid resistant.

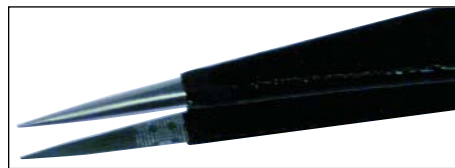

## Fine Round Points For Assembly

Item No.	Description	wt.	Each
445 06	3 SA ESD - 120mm	.082	\$16.88

Anti-static conductive, ESD Safe hypo allergenic tweezers made from Vommeloy. Special stainless steel, anti-magnetic and acid resistant.



## Curved Extra Fine Rounded Tips

Item No.	Description	wt.	Each
445 10	7a SA ESD - 120mm	.082	\$21.80

Anti-static conductive, ESD Safe hypo allergenic tweezers made from Vommeloy. Special stainless steel, anti-magnetic and acid resistant.

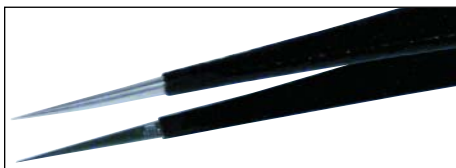

## Long Narrow Body Low Force

Item No.	Description	wt.	Each
445 03	SS SA ESD - 135mm	.076	\$16.88

Anti-static conductive, ESD Safe hypo allergenic tweezers made from Vommeloy. Special stainless steel, anti-magnetic and acid resistant.

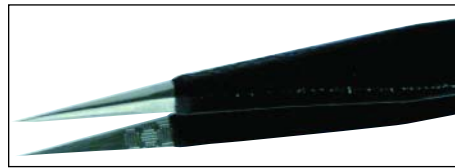

## Fine Round Points Shorter

Item No.	Description	wt.	Each
445 07	3c SA ESD - 110mm	.078	\$16.88

Anti-static conductive, ESD Safe hypo allergenic tweezers made from Vommeloy. Special stainless steel, anti-magnetic and acid resistant.

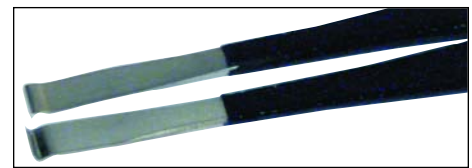

## Holds 0.8 to 2mm Diameter

Item No.	Description	wt.	Each
445 11	50 SA ESD - 120mm	.080	\$17.50

Anti-static conductive, ESD Safe hypo allergenic tweezers made from Vommeloy. Special stainless steel, anti-magnetic and acid resistant.

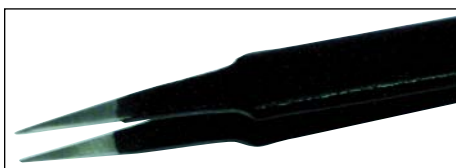

## Reduced Body To Medium Point

Item No.	Description	wt.	Each
445 04	2 SA ESD - 120mm	.082	\$15.82

Anti-static conductive, ESD Safe hypo allergenic tweezers made from Vommeloy. Special stainless steel, anti-magnetic and acid resistant.



## Very Fine Points/Tapered To Tip

Item No.	Description	wt.	Each
445 08	4 SA ESD - 110mm	.080	\$17.40

Anti-static conductive, ESD Safe hypo allergenic tweezers made from Vommeloy. Special stainless steel, anti-magnetic and acid resistant.

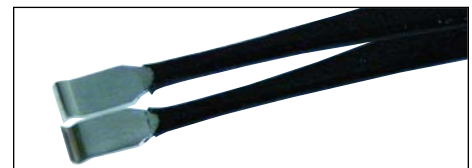

## Holds 1.5 to 3mm Diameter

Item No.	Description	wt.	Each
445 12	51 SA ESD - 120mm	.080	\$17.50

Anti-static conductive, ESD Safe hypo allergenic tweezers made from Vommeloy. Special stainless steel, anti-magnetic and acid resistant.



Made in Germany

www.wihatools.com

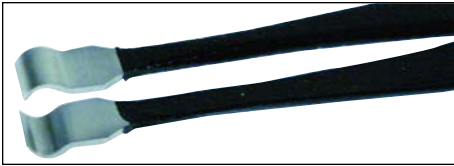

**Holds 3.5 to 7mm Diameter**

Item No.	Description	wt.	Each
445 13	52 SA ESD - 120mm	.082	\$17.50
Anti-static conductive, ESD Safe hypo allergenic tweezers made from Vommelloy. Special stainless steel, anti-magnetic and acid resistant.			

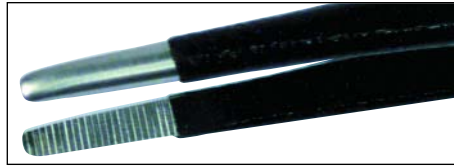

**Universal Blunt Tip Serrated**

Item No.	Description	wt.	Each
445 20	40 SA ESD - 145mm	.114	\$17.30
Anti-static conductive, ESD Safe hypo allergenic tweezers made from Vommelloy. Special stainless steel, anti-magnetic and acid resistant.			

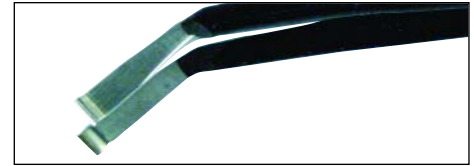

**Flat Bent 35°, 3mm Diameter Grip**

Item No.	Description	wt.	Each
445 24	58 SA-SMD ESD - 117mm	.078	\$18.90
Anti-static conductive, ESD Safe hypo allergenic tweezers made from Vommelloy. Special stainless steel, anti-magnetic and acid resistant.			



**Holds 6.5 to 10mm Diameter**

Item No.	Description	wt.	Each
445 14	53 SA ESD - 120mm	.082	\$17.50
Anti-static conductive, ESD Safe hypo allergenic tweezers made from Vommelloy. Special stainless steel, anti-magnetic and acid resistant.			

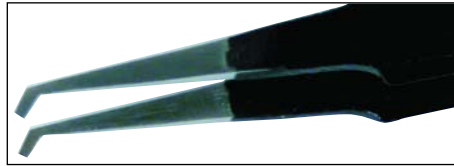

**MicroTip 45° Hook 1x1x2mm**

Item No.	Description	wt.	Each
445 21	12 SA-SMD ESD - 120mm	.086	\$21.20
Anti-static conductive, ESD Safe hypo allergenic tweezers made from Vommelloy. Special stainless steel, anti-magnetic and acid resistant.			

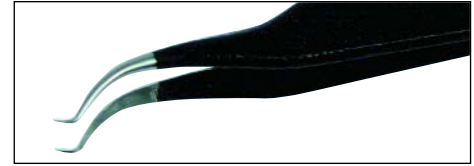

**Curved Extra Fine, 3mm Long Straight Tip**

Item No.	Description	wt.	Each
445 25	7abb SA ESD - 120mm	.082	\$26.10
Anti-static conductive, ESD Safe hypo allergenic tweezers made from Vommelloy. Special stainless steel, anti-magnetic and acid resistant.			



**Angled 3.5 to 7mm Diameter**

Item No.	Description	wt.	Each
445 15	54 SA ESD - 120mm	.080	\$17.50
Anti-static conductive, ESD Safe hypo allergenic tweezers made from Vommelloy. Special stainless steel, anti-magnetic and acid resistant.			

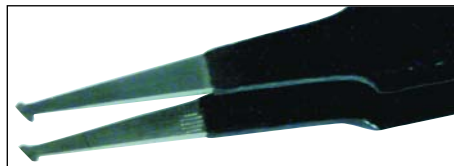

**MicroTip For Chips Angled 1.6x1x1mm**

Item No.	Description	wt.	Each
445 22	13 SA ESD - 120mm	.084	\$21.20
Anti-static conductive, ESD Safe hypo allergenic tweezers made from Vommelloy. Special stainless steel, anti-magnetic and acid resistant.			

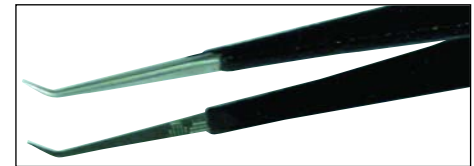

**Narrow Body Low Force Bent 35°-3mm Tip**

Item No.	Description	wt.	Each
445 26	SSbb SA ESD - 140mm	.076	\$21.40
Anti-static conductive, ESD Safe hypo allergenic tweezers made from Vommelloy. Special stainless steel, anti-magnetic and acid resistant.			



**Narrow Rounded Tip Serrated, Guide Pin**

Item No.	Description	wt.	Each
445 18	22 SA ESD - 150mm	.102	\$17.50
Anti-static conductive, ESD Safe hypo allergenic tweezers made from Vommelloy. Special stainless steel, anti-magnetic and acid resistant.			

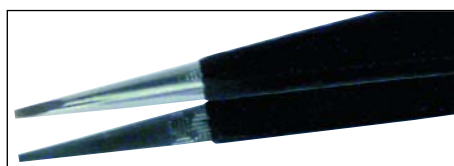

**Long Rounded to 1.0mm Wide No Serration**

Item No.	Description	wt.	Each
445 23	PSF SA ESD - 125mm	.090	\$16.20
Anti-static conductive, ESD Safe hypo allergenic tweezers made from Vommelloy. Special stainless steel, anti-magnetic and acid resistant.			



**Angled Extra Fine Points Bent 30°, 3mm Long Tips**

Item No.	Description	wt.	Each
445 27	5abb SA ESD - 117mm	.076	\$22.10
Anti-static conductive, ESD Safe hypo allergenic tweezers made from Vommelloy. Special stainless steel, anti-magnetic and acid resistant.			



Made in Germany

Toll Free: (800) 494-6104



**Extra Fine Points Bent  
30°, 3mm Long Tips**

Item No.	Description	wt.	Each
445 28	5bb SA ESD - 107mm	.078	\$20.90

Anti-static conductive, ESD Safe hypo allergenic tweezers made from Vommelloy. Special stainless steel, anti-magnetic and acid resistant.



**Heavy Duty Strong Tweezer  
Tapered To Strong Point**

Item No.	Description	wt.	Each
445 32	00 SA ESD - 120mm	.092	\$22.10

Anti-static conductive, ESD Safe hypo allergenic tweezers made from Vommelloy. Special stainless steel, anti-magnetic and acid resistant.

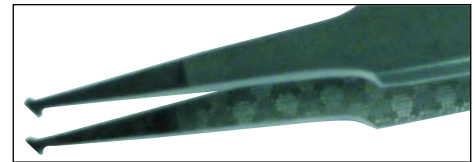

**MicroTip 40° Hook 1.6x1x1mm Wide**

Item No.	Description	wt.	Each
466 13	13 SA SMD - 120mm	.082	\$24.20

Stainless steel, anti-magnetic and acid resistant. Brushed finish tweezers made from Vommelloy.



**MicroTip Bent 30° 1mm  
Wide 0.5mm Slot**

Item No.	Description	wt.	Each
445 29	8b SA ESD - 120mm	.082	\$23.10

Anti-static conductive, ESD Safe hypo allergenic tweezers made from Vommelloy. Special stainless steel, anti-magnetic and acid resistant.



**Angled & Slightly Bent  
With Extra Fine Tips**

Item No.	Description	wt.	Each
445 33	7 SA ESD - 120mm	.082	\$21.40

Anti-static conductive, ESD Safe hypo allergenic tweezers made from Vommelloy. Special stainless steel, anti-magnetic and acid resistant.



**MicroTip Straight & 0.5mm Slot Milled**

Item No.	Description	wt.	Each
466 15	8SA SMD - 120mm	.082	\$24.80

Stainless steel, anti-magnetic and acid resistant. Brushed finish tweezers made from Vommelloy.

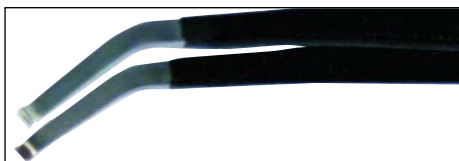

**Flat Bent 35°, 2mm  
Diameter Grip Radius**

Item No.	Description	wt.	Each
445 30	59 SA-SMD ESD - 117mm	.080	\$18.90

Anti-static conductive, ESD Safe hypo allergenic tweezers made from Vommelloy. Special stainless steel, anti-magnetic and acid resistant.

**Microscopy Tweezers**



**MicroTip 30° Bend &  
0.5mm Slot Milled**

Item No.	Description	wt.	Each
466 11	11SA ESD - 117mm	.082	\$25.30

Stainless steel, anti-magnetic and acid resistant. Brushed finish tweezers made from Vommelloy.



**MicroTip Bent 30° -  
1mm Wide 0.5mm Slot**

Item No.	Description	wt.	Each
466 16	8b SA SMD - 120mm	.082	\$25.60

Stainless steel, anti-magnetic and acid resistant. Brushed finish tweezers made from Vommelloy.



**ESD Safe General Purpose  
Fine Point**

Item No.	Description	wt.	Each
445 31	1 SA ESD - 120mm	.084	\$17.40

Anti-static conductive, ESD Safe hypo allergenic tweezers made from Vommelloy. Special stainless steel, anti-magnetic and acid resistant.

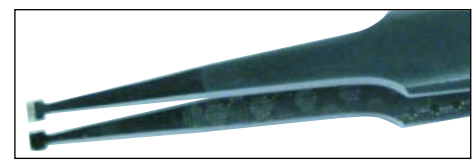

**MicroTip Straight, 0.5mm Slot,  
Radius End**

Item No.	Description	wt.	Each
466 17	8a SA SMD - 120mm	.080	\$28.10

Stainless steel, anti-magnetic and acid resistant. Brushed finish tweezers made from Vommelloy.

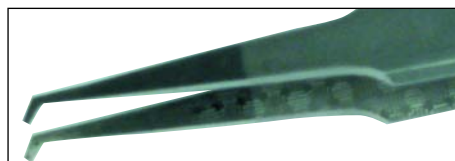

**MicroTip 40° Hook 1x1x2mm Long**

Item No.	Description	wt.	Each
466 12	12SA ESD - 120mm	.084	\$24.20

Stainless steel, anti-magnetic and acid resistant. Brushed finish tweezers made from Vommelloy.



**MicroTip 30° Bent &  
Angled With 0.5 Slot**

Item No.	Description	wt.	Each
466 19	19 SA SMD - 120mm	.082	\$26.20

Stainless steel, anti-magnetic and acid resistant. Brushed finish tweezers made from Vommelloy.



Made in Germany

www.wihatools.com

# Professional Quality Tweezers

## IN STANDARD AND SPECIAL SIZES



**Blunt Tip, Serrated**

Item No.	Description	wt.	Each
430 10	40 - 145mm	.106	\$13.60

Carbon steel tweezers. Nickel-plated finish.

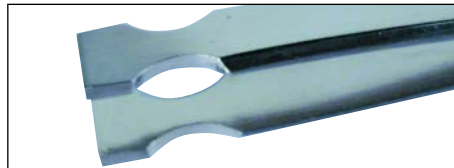

**Forming Tweezer with Flush Ends**

Item No.	Description	wt.	Each
438 02	8B - 100mm	.092	\$18.90

Carbon steel tweezers. Nickel-plated finish.



**Curved Extra Fine, 3mm Long Angled Tip**

Item No.	Description	wt.	Each
469 50	7abb SA - 120mm	.074	\$28.90

Stainless steel, anti-magnetic and acid resistant.  
Brushed finish tweezers made from Vommeloy.

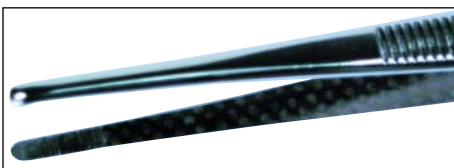

**Blunt Tip Serrated**

Item No.	Description	wt.	Each
430 14	40 SA - 145mm	.114	\$18.40

Stainless steel, anti-magnetic and acid resistant.  
Brushed finish tweezers made from Vommeloy.

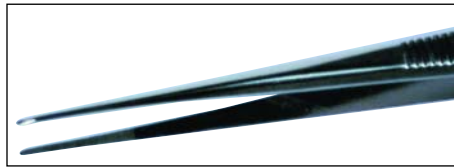

**Long Tapered to Fine Tip Serrated**

Item No.	Description	wt.	Each
450 10	30 - 145mm	.092	\$13.60

Carbon steel tweezers. Nickel-plated finish.



**Fine Points Angled with 40° - Tip Bend**

Item No.	Description	wt.	Each
469 70	5abb SA - 117mm	.070	\$24.60

Stainless steel, anti-magnetic and acid resistant.  
Brushed finish tweezers made from Vommeloy.

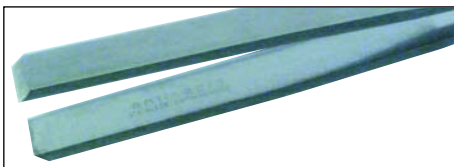

**Heavy Duty Forming Tweezer**

Item No.	Description	wt.	Each
438 00	8 SA - 120mm	.102	\$21.50

Stainless steel, anti-magnetic and acid resistant.  
Brushed finish tweezers made from Vommeloy.

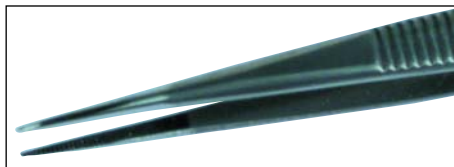

**Tapered to Fine Tip Serrated**

Item No.	Description	wt.	Each
452 10	34 SA - 120mm	.076	\$17.80

Stainless steel, anti-magnetic and acid resistant.  
Brushed finish tweezers made from Vommeloy.

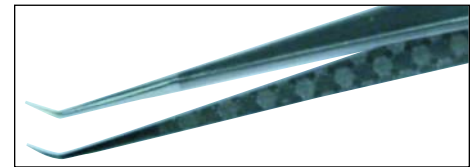

**Narrow Body Low Force Bent 35° - 3mm Long Tip**

Item No.	Description	wt.	Each
469 71	SSbb SA - 140mm	.072	\$23.70

Stainless steel, anti-magnetic and acid resistant.  
Brushed finish tweezers made from Vommeloy.

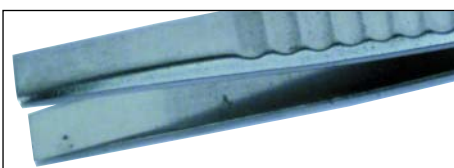

**Forming Tweezers with Grip Panel**

Item No.	Description	wt.	Each
438 01	8a - 100mm	.092	\$18.70

Carbon steel tweezers. Nickel-plated finish.



**Bent Fine Tip & Serrated**

Item No.	Description	wt.	Each
452 11	34b SA - 120mm	.076	\$18.90

Stainless steel, anti-magnetic and acid resistant.  
Brushed finish tweezers made from Vommeloy.



**Extra Fine Points Bent 30° 3mm Long Tip**

Item No.	Description	wt.	Each
469 72	5bb SA - 107mm	.070	\$23.60

Stainless steel, anti-magnetic and acid resistant.  
Brushed finish tweezers made from Vommeloy.



Made in Germany

Toll Free: (800) 494-6104

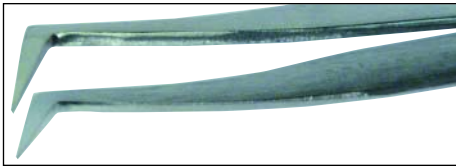

**Fine Hooked & Tapered Tips**

Item No.	Description	wt.	Each
469 87	6 SA - 120mm	.076	\$24.50

Stainless steel, anti-magnetic and acid resistant.  
Brushed finish tweezers made from Vommeloy.



**Blunt 1mm Wide Tip Serrated**

Item No.	Description	wt.	Each
491 85	PSF - 125mm	.080	\$13.70

Carbon steel tweezers. Nickel-plated finish.



**Curved Extra Fine Tips**

Item No.	Description	wt.	Each
493 76	7a SA - 120mm	.072	\$24.80

Stainless steel, anti-magnetic and acid resistant.  
Brushed finish tweezers made from Vommeloy.



**Strong Tweezer Tapered To Point**

Item No.	Description	wt.	Each
481 50	OO S - 130mm	.076	\$13.70

Stainless steel tweezers. Brushed finish.

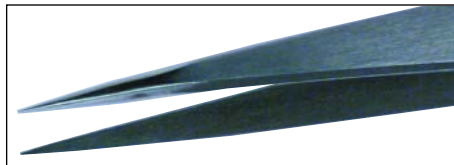

**Universal Fine Points Tweezer**

Item No.	Description	wt.	Each
492 84	AA S - 130mm	.078	\$14.10

Stainless steel tweezers. Natural finish.

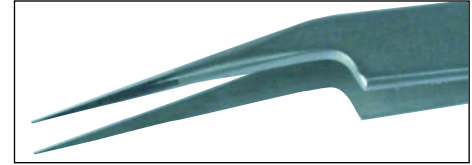

**Fine Points Angled for Visibility**

Item No.	Description	wt.	Each
493 77	5a SA - 110mm	.078	\$21.50

Stainless steel, anti-magnetic and acid resistant.  
Brushed finish tweezers made from Vommeloy.

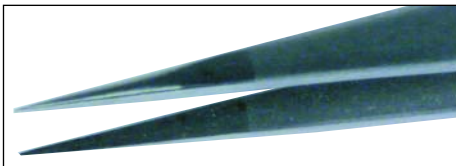

**Heavy Duty Strong Tweezer Tapered To Strong Point**

Item No.	Description	wt.	Each
487 00	OO SA - 120mm	.084	\$23.20

Stainless steel, anti-magnetic and acid resistant.  
Brushed finish tweezers made from Vommeloy.



**Flat Round Tip Bent 30° Smooth Sides**

Item No.	Description	wt.	Each
493 68	2ab SA - 120mm	.078	\$25.40

Stainless steel, anti-magnetic and acid resistant.  
Brushed finish tweezers made from Vommeloy.

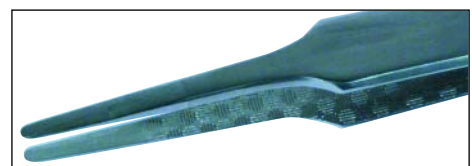

**Flat Round Tip Smooth Sides**

Item No.	Description	wt.	Each
493 78	2a SA - 120mm	.072	\$20.40

Stainless steel, anti-magnetic and acid resistant.  
Brushed finish tweezers made from Vommeloy.

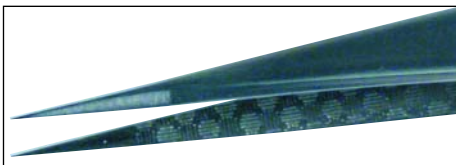

**General Purpose Fine Points**

Item No.	Description	wt.	Each
489 80	1 SA - 120mm	.076	\$19.40

Stainless steel, anti-magnetic and acid resistant.  
Brushed finish tweezers made from Vommeloy.

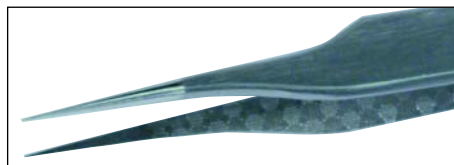

**Angled Upward Extra Fine Tips**

Item No.	Description	wt.	Each
493 75	7 SA - 120mm	.076	\$22.50

Stainless steel, anti-magnetic and acid resistant.  
Brushed finish tweezers made from Vommeloy.



**Extra Fine Points & Tapered To Tip**

Item No.	Description	wt.	Each
493 79	5 SA - 110mm	.074	\$20.80

Stainless steel, anti-magnetic and acid resistant.  
Brushed finish tweezers made from Vommeloy.



**Universal Fine Points Tweezer**

Item No.	Description	wt.	Each
491 84	AA - 130mm	.080	\$12.10

Carbon steel tweezers. Nickel-plated finish.



Made in Germany

www.wihatools.com



**Very Fine Points Bent 40°  
Tapered To Tip**

Item No.	Description	wt.	Each
493 80	4b SA - 110mm	.078	\$21.80

Stainless steel, anti-magnetic and acid resistant.  
Brushed finish tweezers made from Vomalloy.

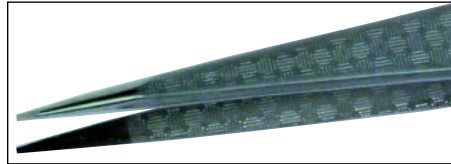

**Blunt Tips - 1.0mm Wide Serrated**

Item No.	Description	wt.	Each
493 85	PSF SA - 125mm	.086	\$16.40

Stainless steel, anti-magnetic and acid resistant.  
Brushed finish tweezers made from Vomalloy.



**Bent Flat & Broad Tips 3mm Wide**

Item No.	Description	wt.	Each
496 40	Fb SA - 120mm	.080	\$24.50

Stainless steel, anti-magnetic and acid resistant.  
Brushed finish tweezers made from Vomalloy.

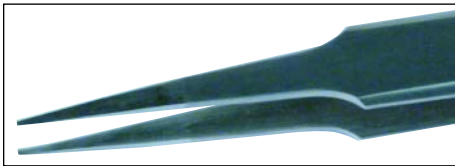

**Reduced Body to Medium Point**

Item No.	Description	wt.	Each
493 81	2 SA - 120mm	.078	\$20.60

Stainless steel, anti-magnetic and acid resistant.  
Brushed finish tweezers made from Vomalloy.

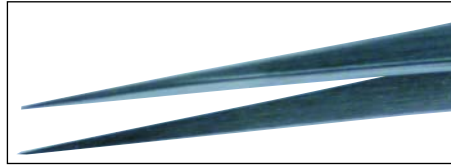

**Long Narrow Body Low Force**

Item No.	Description	wt.	Each
493 87	SS SA - 140mm	.074	\$20.50

Stainless steel, anti-magnetic and acid resistant.  
Brushed finish tweezers made from Vomalloy.



**Very Fine Round Points &  
Tapered To Tip**

Item No.	Description	wt.	Each
497 79	4 SA - 110mm	.076	\$20.80

Stainless steel, anti-magnetic and acid resistant.  
Brushed finish tweezers made from Vomalloy.



**Flat and Broad Tips 3mm Wide**

Item No.	Description	wt.	Each
493 82	F SA - 120mm	.076	\$20.70

Stainless steel, anti-magnetic and acid resistant.  
Brushed finish tweezers made from Vomalloy.



**Strong, Long Tapered Fine Tips**

Item No.	Description	wt.	Each
493 88	GG SA - 130mm	.090	\$21.90

Stainless steel, anti-magnetic and acid resistant.  
Brushed finish tweezers made from Vomalloy.



**Fine Round Points Shorter**

Item No.	Description	wt.	Each
497 83	3c SA - 110mm	.078	\$20.80

Stainless steel, anti-magnetic and acid resistant.  
Brushed finish tweezers made from Vomalloy.

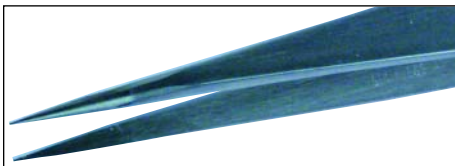

**Fine Points for Assembly**

Item No.	Description	wt.	Each
493 83	3 SA - 120mm	.076	\$20.70

Stainless steel, anti-magnetic and acid resistant.  
Brushed finish tweezers made from Vomalloy.

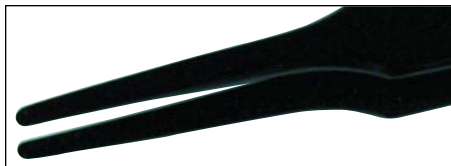

**Flat Round Tip Smooth Sides**

Item No.	Description	wt.	Each
494 78	2a SA T - 120mm	.080	\$31.20

Stainless steel, anti-magnetic and acid resistant.  
Teflon finish tweezers made from Vomalloy.

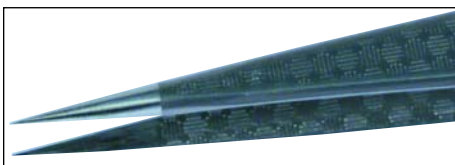

**Universal Fine Points Tweezer**

Item No.	Description	wt.	Each
493 84	AA SA - 130mm	.088	\$15.00

Stainless steel, anti-magnetic and acid resistant.  
Brushed finish tweezers made from Vomalloy.

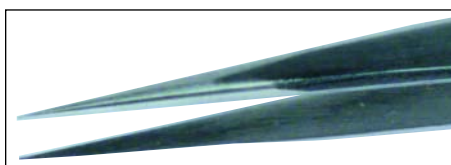

**Longer Narrow Body Low Force**

Item No.	Description	wt.	Each
494 87	SSL SA - 160mm	.096	\$25.90

Stainless steel, anti-magnetic and acid resistant.  
Brushed finish tweezers made from Vomalloy.



**Very Fine Points Bent & Tapered Long**

Item No.	Description	wt.	Each
498 79	4L SA - 140mm	.082	\$26.00

Stainless steel, anti-magnetic and acid resistant.  
Brushed finish tweezers made from Vomalloy.





Made in Germany

Toll Free: (800) 494-6104

# Professional Quality Wafer Tweezers



**Back Stop, Top Is 2.4 Wide Bottom 7mm Wide, Teflon Coat**

Item No.	Description	wt.	Each
437 31	37 SA T - 120mm	.076	\$48.10
Stainless steel, anti-magnetic and acid resistant. Teflon PTFE finish tweezers.			

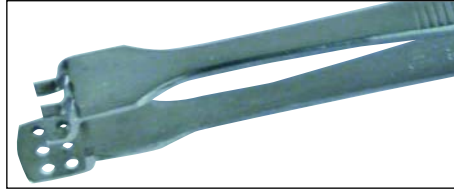

**9mm Wide With Back Stop Pins**

Item No.	Description	wt.	Each
439 48	89 SA - 125mm	.080	\$28.40
Stainless steel, anti-magnetic and acid resistant. Brushed finish tweezers made from Vommaloy.			



**16mm Limit Access & Back Stop**

Item No.	Description	wt.	Each
450 39	150 SA - 125mm	.096	\$45.20
Stainless steel, anti-magnetic and acid resistant. Brushed finish tweezers made from Vommaloy.			



**12mm Wide Teflon Pivot Pad**

Item No.	Description	wt.	Each
437 79	77 SA - 125mm	.084	\$44.90
Stainless steel, anti-magnetic and acid resistant. Brushed finish tweezers made from Vommaloy.			



**12mm Wide With Back Stop Pins**

Item No.	Description	wt.	Each
439 49	89a SA - 125mm	.080	\$27.90
Stainless steel, anti-magnetic and acid resistant. Brushed finish tweezers made from Vommaloy.			



**Bent Large 20mm Wide, Back Stop**

Item No.	Description	wt.	Each
460 69	61 SA - 125mm	.108	\$43.80
Stainless steel, anti-magnetic and acid resistant. Brushed finish tweezers made from Vommaloy.			

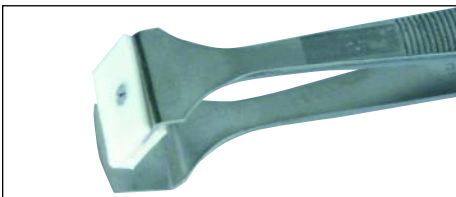

**20mm Teflon Pivot Pad**

Item No.	Description	wt.	Each
437 80	79 SA - 125mm	.112	\$55.50
Stainless steel, anti-magnetic and acid resistant. Brushed finish tweezers made from Vommaloy.			



**Angled 4 Pin 12mm Wide**

Item No.	Description	wt.	Each
441 49	16 SA - 125mm	.080	\$27.70
Stainless steel, anti-magnetic and acid resistant. Wafer tweezers made from Vommaloy.			



**Small Narrow 3mm Blunt Point**

Item No.	Description	wt.	Each
472 99	72a SA - 115mm	.076	\$27.20
Stainless steel, anti-magnetic and acid resistant. Brushed finish tweezers made from Vommaloy.			

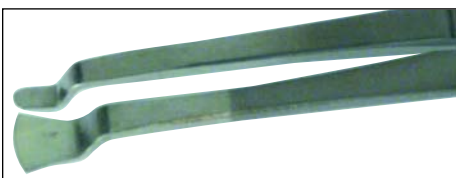

**Back Stop, Top 2.4 Bottom 7mm**

Item No.	Description	wt.	Each
437 99	37 SA - 120mm	.076	\$37.50
Stainless steel, anti-magnetic and acid resistant. Brushed finish tweezers made from Vommaloy.			



**16mm Wide With Back Stop**

Item No.	Description	wt.	Each
441 59	49 SA - 125mm	.094	\$29.00
Stainless steel, anti-magnetic and acid resistant. Brushed finish tweezers made from Vommaloy.			

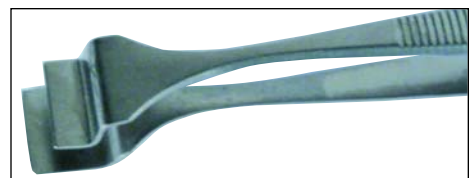

**Angled 12mm Wide Flat, Back Stop**

Item No.	Description	wt.	Each
476 00	91 SA - 125mm	.080	\$26.80
Stainless steel, anti-magnetic and acid resistant. Brushed finish tweezers made from Vommaloy.			



Made in Germany

www.wihatools.com

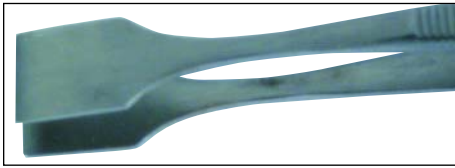

**Flat Straight 12mm Wide**

Item No.	Description	wt.	Each
477 15	36 SA - 125mm	.082	\$20.90
Stainless steel, anti-magnetic and acid resistant. Brushed finish tweezers made from Vommeloy.			



**Flat Straight Narrow 5mm Wide**

Item No.	Description	wt.	Each
495 85	38 SA - 105mm	.076	\$19.70
Stainless steel, anti-magnetic and acid resistant. Brushed finish tweezers made from Vommeloy.			



**Flat Angled 8mm Wide**

Item No.	Description	wt.	Each
496 20	27a SA - 125mm	.080	\$29.50
Stainless steel, anti-magnetic and acid resistant. Brushed finish tweezers made from Vommeloy.			

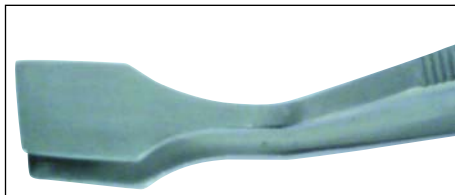

**Flat Angled 12mm Wide**

Item No.	Description	wt.	Each
477 16	36a SA - 125mm	.084	\$22.40
Stainless steel, anti-magnetic and acid resistant. Brushed finish tweezers made from Vommeloy.			

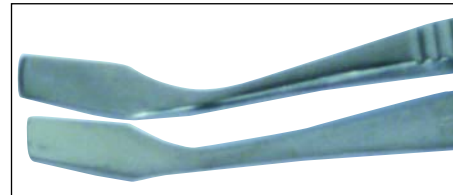

**Flat Angled 5mm Wide**

Item No.	Description	wt.	Each
495 87	38a SA - 103mm	.078	\$21.30
Stainless steel, anti-magnetic and acid resistant. Brushed finish tweezers made from Vommeloy.			



**End Cutting Tweezer**

Item No.	Description	wt.	Each
465 00	D - 95mm	.106	\$23.40
Carbon steel. UnPlated finish.			

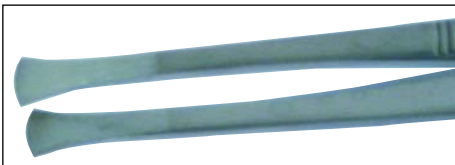

**Half Round Thin 7mm Wide**

Item No.	Description	wt.	Each
479 82	35a SA - 120mm	.076	\$21.00
Stainless steel, anti-magnetic and acid resistant. Brushed finish tweezers made from Vommeloy.			

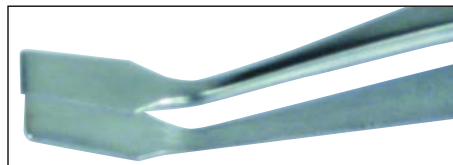

**Long Angled 5mm Wide**

Item No.	Description	wt.	Each
495 88	39a SA - 123mm	.080	\$22.40
Stainless steel, anti-magnetic and acid resistant. Brushed finish tweezers made from Vommeloy.			



**Curved Very Fine Cutting Tweezer**

Item No.	Description	wt.	Each
483 07	C7 - 115mm	.082	\$69.90
Carbon steel made from Vommeloy. Brushed finish.			



**Long Flat Straight 5mm Wide**

Item No.	Description	wt.	Each
495 84	39 SA - 125mm	.078	\$20.60
Stainless steel, anti-magnetic and acid resistant. Brushed finish tweezers made from Vommeloy.			

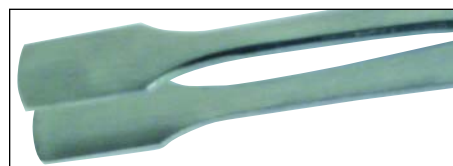

**Flat Straight 8mm Wide**

Item No.	Description	wt.	Each
496 00	27 SA - 125mm	.080	\$21.50
Stainless steel, anti-magnetic and acid resistant. Brushed finish tweezers made from Vommeloy.			

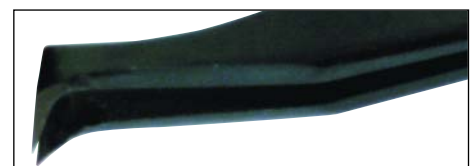

**Angled Head, Cutting Nippers**

Item No.	Description	wt.	Each
495 01	1 5a - 115mm	.106	\$68.40
Carbon steel. Natural finish.			



Made in Germany

Toll Free: (800) 494-6104

# Professional Quality Guide Pins Tweezers

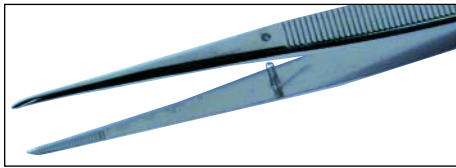

**Fine Tip Straight, Guide Pin,  
Fine Serrated**

Item No.	Description	wt.	Each
420 12	17 - 120mm Carbon steel. Nickel-plated finish.	.078	\$13.60

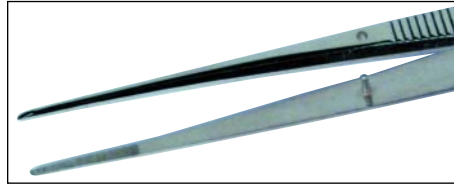

**Long Straight, Guide Pin,  
Fine Serrated**

Item No.	Description	wt.	Each
450 12	31 - 145mm Carbon steel. Nickel-plated finish.	.096	\$16.00

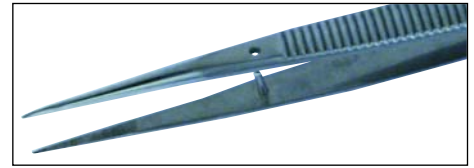

**Universal Straight Guide Pin,  
Fine Serrated**

Item No.	Description	wt.	Each
452 12	35 SA - 120mm Stainless steel, anti-magnetic and acid resistant. Brushed Finish tweezers made from Vommeloy.	.078	\$20.00

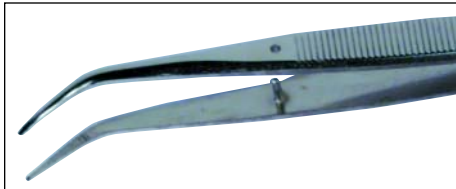

**Fine Tip Bent, Guide Pin,  
Fine Serrated**

Item No.	Description	wt.	Each
420 13	17B - 120mm Carbon steel. Nickel-plated finish.	.078	\$16.20

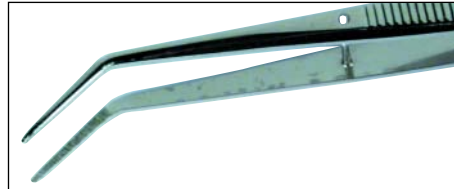

**Long Bent, Guide Pin, Serrated**

Item No.	Description	wt.	Each
450 13	31b - 145mm Carbon steel. Nickel-plated finish.	.092	\$20.00



**Fine Bent, Guide Pin, Serrated**

Item No.	Description	wt.	Each
452 13	35B SA - 145mm Stainless steel, anti-magnetic and acid resistant. Brushed Finish tweezers made from Vommeloy.	.078	\$21.80

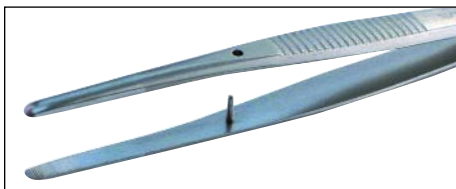

**Blunt Tip Straight,  
Guide Pin, Serrated**

Item No.	Description	wt.	Each
432 12	45 SA - 120mm Stainless steel, anti-magnetic and acid resistant. Brushed Finish tweezers made from Vommeloy.	.088	\$19.50

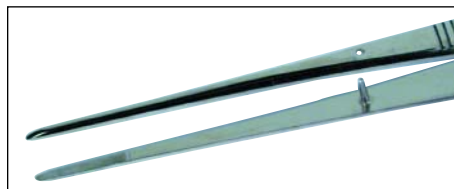

**Longer Straight, Guide Pin,  
Fine Serrated**

Item No.	Description	wt.	Each
451 12	33 - 165mm Carbon steel. Nickel-plated finish.	.102	\$20.50

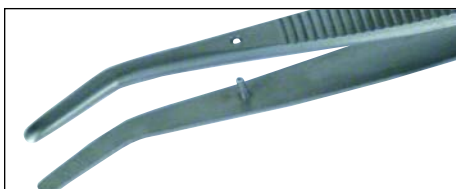

**Heavy, Blunt, Straight, Guide  
Pin, Serrated Tweezer**

Item No.	Description	wt.	Each
432 13	45b SA - 120mm Stainless steel, anti-magnetic and acid resistant. Brushed Finish tweezers made from Vommeloy.	.088	\$20.70



**Bent, Long, Guide Pin,  
Fine Serrated Tweezer**

Item No.	Description	wt.	Each
451 13	33b - 165mm Carbon steel. Nickel-plated finish.	.102	\$21.60

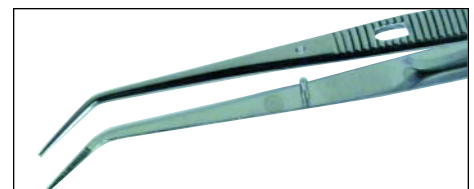

**Long Pointed, Angled Tip,  
Guide Pin & Lock**

Item No.	Description	wt.	Each
491 50	20S - 150mm Stainless steel. Polished finish.	.096	\$39.90



Made in Germany

www.wihatools.com

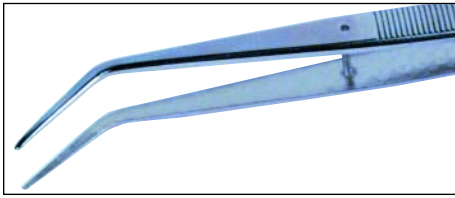

**Narrow Body, Bent, Long, Guide Pin, Serrated Tweezer**

Item No.	Description	wt.	Each
491 53	22b - 155mm	.096	\$15.40

Carbon steel. Nickel-plated finish.

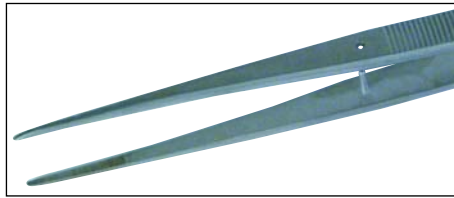

**Narrow Body, Straight, Long, Guide Pin, Serrated Tweezer**

Item No.	Description	wt.	Each
491 59	22 SA - 155mm	.102	\$19.70

Stainless steel, anti-magnetic and acid resistant.  
Brushed Finish tweezers made from Vommeloy.

**Long Tweezers With Cross Tips**

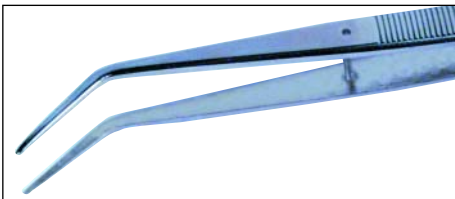

**Narrow Body, Bent, Long, Guide Pin, Serrated Tweezer**

Item No.	Description	wt.	Each
491 54	22b S - 155mm	.094	\$18.10

Stainless steel. Natural finish.

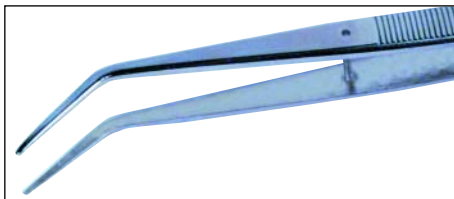

**Narrow Body, Bent, Long, Guide Pin, Serrated Tweezer**

Item No.	Description	wt.	Each
491 60	22b SA - 155mm	.102	\$19.70

Stainless steel, anti-magnetic and acid resistant.  
Brushed Finish tweezers made from Vommeloy.

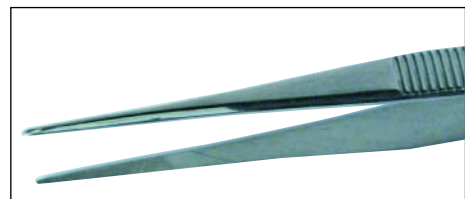

**Rounded Tip Long With Grip Pattern**

Item No.	Description	wt.	Each
497 09	D13 SA - 160mm	.098	\$21.70

Stainless steel, anti-magnetic and acid resistant.  
Brushed Finish tweezers made from Vommeloy.

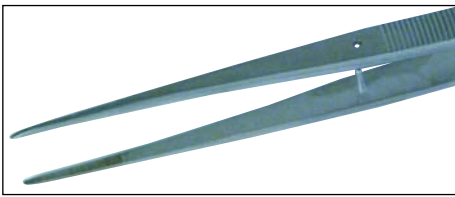

**Narrow Body, Straight, Long, Guide Pin, Serrated Tweezer**

Item No.	Description	wt.	Each
491 55	22 - 155mm	.094	\$14.90

Carbon steel. Nickel-plated finish.

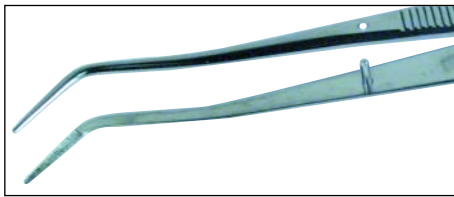

**Narrow Body, Bent & Angled, Long, Guide Pin, Serrated**

Item No.	Description	wt.	Each
491 61	24 S - 155mm	.092	\$24.90

Stainless steel. Natural finish.

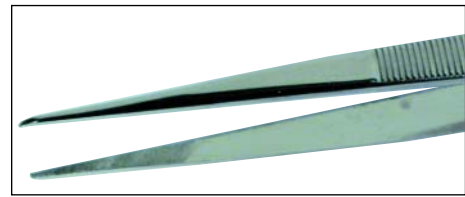

**Rounded Tip Long with Grip Pattern**

Item No.	Description	wt.	Each
497 14	D13 - 160mm	.096	\$19.00

Carbon steel. Nickel-plated finish.

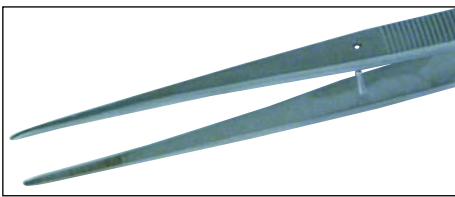

**Narrow Body, Straight, Long, Guide Pin, Serrated Tweezer**

Item No.	Description	wt.	Each
491 56	22 S - 155mm	.094	\$17.00

Stainless steel. Natural finish.



**Rounded Tip Long With Grip Pattern**

Item No.	Description	wt.	Each
497 16	D13 S - 160mm	.094	\$20.20

Stainless steel. Natural finish.



Made in Germany

Toll Free: (800) 494-6104

# Professional Quality SMD

## COMPONENT POSITIONING & DESOLDERING TWEEZERS



**Holds 0.8 to 2.0 Diameter**

Item No.	Description	wt.	Each
421 41	50 SA - 120mm	.078	\$20.10
Stainless steel, anti-magnetic and acid resistant. Brushed Finish tweezers made from Vomalloy.			

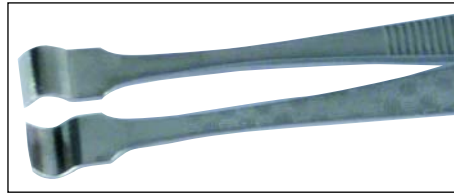

**Holds 3.5 to 7mm Diameter**

Item No.	Description	wt.	Each
421 49	52 SA - 120mm	.078	\$20.10
Stainless steel, anti-magnetic and acid resistant. Brushed Finish tweezers made from Vomalloy.			

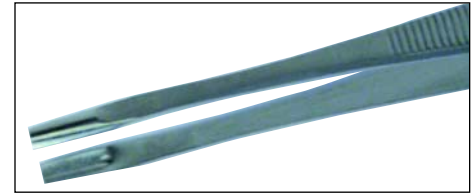

**Vertical 1.5 to 3.5mm Diameter**

Item No.	Description	wt.	Each
421 55	55 SA - 120mm	.078	\$20.10
Stainless steel, anti-magnetic and acid resistant. Brushed Finish tweezers made from Vomalloy.			

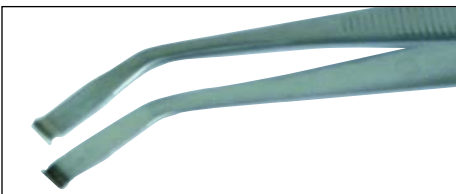

**Flat Bent 35° 3mm Dia. Milled Slot**

Item No.	Description	wt.	Each
421 42	58 SA SMD - 117mm	.076	\$21.60
Stainless steel, anti-magnetic and acid resistant. Brushed Finish tweezers made from Vomalloy.			

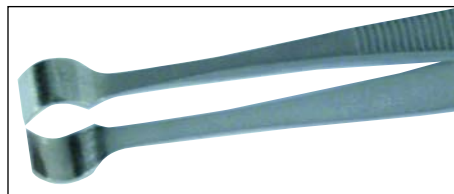

**Holds 6.5 to 10mm Diameter**

Item No.	Description	wt.	Each
421 50	53 SA - 120mm	.076	\$20.10
Stainless steel, anti-magnetic and acid resistant. Brushed Finish tweezers made from Vomalloy.			

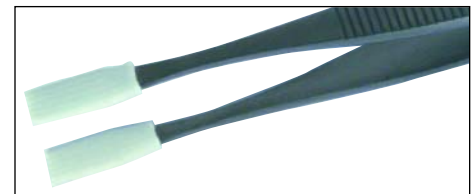

**Silicon Covered Flat  
Long 5mm Wide**

Item No.	Description	wt.	Each
434 13	68 SA - 145mm	.104	\$30.40
Stainless steel, anti-magnetic and acid resistant. Brushed Finish tweezers made from Vomalloy.			

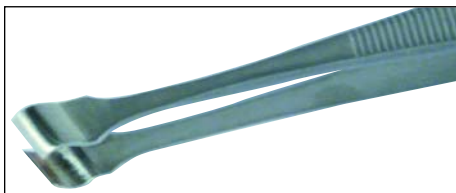

**Angled 3.5 to 7mm Diameter**

Item No.	Description	wt.	Each
421 46	54 SA - 120mm	.080	\$20.10
Stainless steel, anti-magnetic and acid resistant. Brushed Finish tweezers made from Vomalloy.			



**Flat Straight 3mm Diameter**

Item No.	Description	wt.	Each
421 51	56 SA - 120mm	.078	\$20.10
Stainless steel, anti-magnetic and acid resistant. Brushed Finish tweezers made from Vomalloy.			



**Vertical Long, Holds  
2.5 to 5mm Diameter**

Item No.	Description	wt.	Each
434 14	64 SA - 145mm	.102	\$23.50
Stainless steel, anti-magnetic and acid resistant. Brushed Finish tweezers made from Vomalloy.			



**Holds 1.5 to 3.0 Diameter**

Item No.	Description	wt.	Each
421 48	51 SA - 120mm	.078	\$20.10
Stainless steel, anti-magnetic and acid resistant. Brushed Finish tweezers made from Vomalloy.			

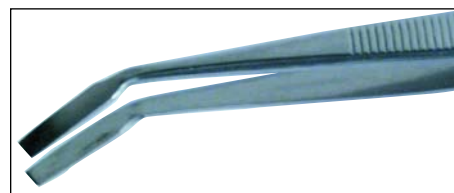

**Flat Bent 35° 3mm Diameter**

Item No.	Description	wt.	Each
421 52	57 SA - 120mm	.078	\$20.80
Stainless steel, anti-magnetic and acid resistant. Brushed Finish tweezers made from Vomalloy.			

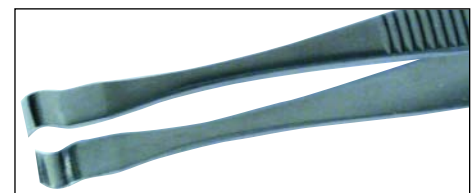

**Long, Holds 3.5 to 7mm Diameter**

Item No.	Description	wt.	Each
434 16	62 SA - 145mm	.108	\$23.50
Stainless steel, anti-magnetic and acid resistant. Brushed Finish tweezers made from Vomalloy.			



Made in Germany

www.wihatools.com



**Long Bent at Tips 5mm Wide**

Item No.	Description	wt.	Each
434 17	67 SA - 145mm	.104	\$23.40

Stainless steel, anti-magnetic and acid resistant.  
Brushed Finish tweezers made from Vommeloy.

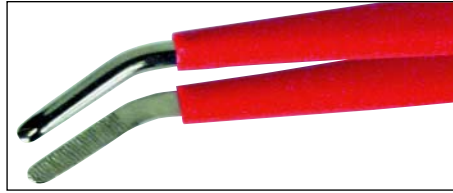

**Blunt End Bent Isolated & Serrated**

Item No.	Description	wt.	Each
430 16	40b isol - 145mm	.122	\$15.50

Carbon steel. Nickel-plated finish.

**Super Thin  
Foil Tweezers**

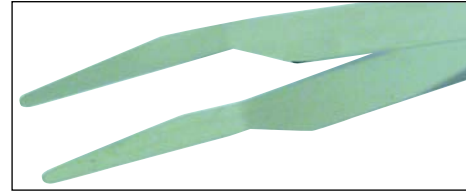

**Blunt, Thin .035", Very Low Force**

Item No.	Description	wt.	Each
492 15	112 SA - 100mm	.052	\$25.90

Stainless steel, anti-magnetic and acid resistant.  
Polished finish tweezers made from Vommeloy.

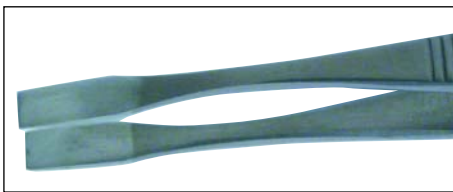

**Flat Long & Straight 5mm Wide**

Item No.	Description	wt.	Each
434 18	66 SA - 145mm	.102	\$23.40

Stainless steel, anti-magnetic and acid resistant.  
Brushed Finish tweezers made from Vommeloy.

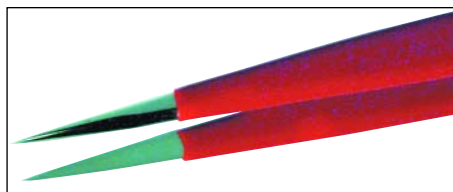

**Universal Pointed Tip Isolated**

Item No.	Description	wt.	Each
481 00	AA isol - 130mm	.096	\$17.20

Carbon steel. Nickel-plated finish.

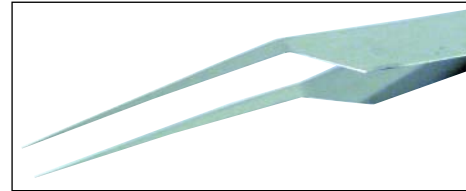

**Pointed, Thin .035", Very Low Force**

Item No.	Description	wt.	Each
492 20	113 SA - 100mm	.052	\$26.30

Stainless steel, anti-magnetic and acid resistant.  
Polished finish tweezers made from Vommeloy.

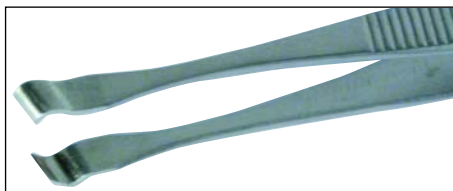

**Bent Long, Holds 3.5 to  
7mm Diameter**

Item No.	Description	wt.	Each
434 19	63 SA - 145mm	.102	\$23.40

Stainless steel, anti-magnetic and acid resistant.  
Brushed Finish tweezers made from Vommeloy.

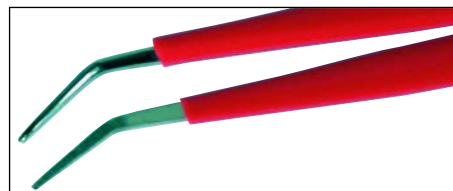

**Narrow Pointed, Bent,  
Isolated Serrated**

Item No.	Description	wt.	Each
491 57	22b isol - 145mm	.104	\$16.70

Carbon steel. Nickel-plated finish.

**Self Closing  
Tweezers**



**Long Straight Tweezer**

Item No.	Description	wt.	Each
432 70	R29 S - 160mm	.114	\$23.70

Stainless steel, anti-magnetic and acid resistant.  
Brushed Finish tweezers made from Vommeloy.

**Isolated Tweezers  
With Dipped Handles**

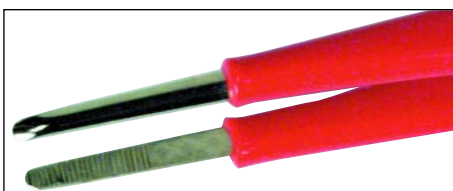

**Blunt End Straight  
Isolated & Serrated**

Item No.	Description	wt.	Each
430 15	40 isol - 145mm	.122	\$14.30

Carbon steel. Nickel-plated finish.

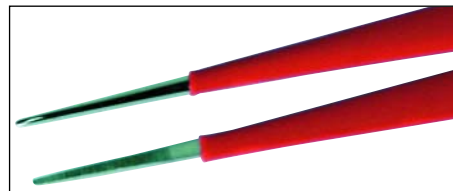

**Narrow Pointed & Straight  
Isolated Serrated**

Item No.	Description	wt.	Each
491 58	22 isol - 155mm	.104	\$15.80

Carbon steel. Nickel-plated finish.



**Long Bent Tweezer**

Item No.	Description	wt.	Each
432 71	R29b SA - 160mm	.116	\$25.10

Stainless steel, anti-magnetic and acid resistant.  
Brushed Finish tweezers made from Vommeloy.



Made in Germany

Toll Free: (800) 494-6104

# Professional Quality Tweezers

## SELF CLOSING TWEEZERS

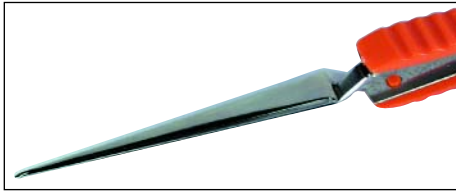

**Pointed Self Closing  
Long Straight**

Item No.	Description	wt.	Each
432 72	R29 - 160mm	.112	\$20.20

Carbon steel. Nickel-plated finish.



**Reverse 2 Flat Round Tip  
Smooth Sides**

Item No.	Description	wt.	Each
458 02	R2a SA - 115mm	.078	\$26.90

Stainless steel, anti-magnetic and acid resistant.  
Brushed Finish tweezers made from Vommeloy.



**Chip Holding Curved Fine Micro Tip**

Item No.	Description	wt.	Each
466 10	R10 SA SMD - 117mm	.074	\$43.90

Stainless steel, anti-magnetic and acid resistant.  
Brushed Finish tweezers made from Vommeloy.

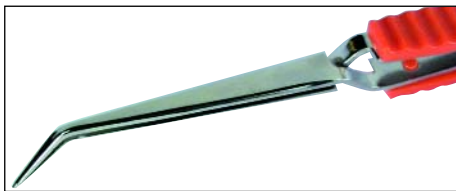

**Long Bent Tweezer**

Item No.	Description	wt.	Each
432 73	R29b - 160mm	.118	\$21.50

Carbon steel. Nickel-plated finish.



**Reverse 3 Fine Round Points  
For Assembly**

Item No.	Description	wt.	Each
458 03	R3 SA - 115mm	.078	\$26.90

Stainless steel, anti-magnetic and acid resistant.  
Brushed Finish tweezers made from Vommeloy.



**Straight Flat Square End 5mm Wide**

Item No.	Description	wt.	Each
480 50	R50 SA - 105mm	.074	\$29.50

Stainless steel, anti-magnetic and acid resistant.  
Brushed Finish tweezers made from Vommeloy.

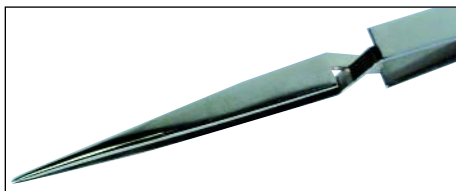

**Pointed Self Closing  
LD Long Straight**

Item No.	Description	wt.	Each
432 74	R28 - 160mm	.110	\$16.10

Carbon steel. Nickel-plated finish.

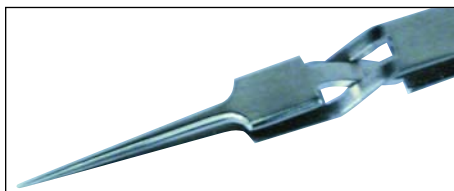

**5 Extra Fine Points, Tapered To Tip**

Item No.	Description	wt.	Each
458 05	R5 SA - 105mm	.072	\$26.90

Stainless steel, anti-magnetic and acid resistant.  
Brushed Finish tweezers made from Vommeloy.



**Bent Flat Square End 5mm Wide**

Item No.	Description	wt.	Each
480 51	R50b SA - 105mm	.074	\$32.90

Stainless steel, anti-magnetic and acid resistant.  
Brushed Finish tweezers made from Vommeloy.



**Blunt Heat Dissipating Copper Tips**

Item No.	Description	wt.	Each
432 75	R32 - 160mm	.124	\$29.90

Carbon steel, Copper. Nickel-plated finish.



**7 Curved Extra Fine Rounded Tips**

Item No.	Description	wt.	Each
458 07	R7a SA - 115mm	.074	\$32.50

Stainless steel, anti-magnetic and acid resistant.  
Brushed Finish tweezers made from Vommeloy.



**Strong With Square  
Ends Deep Serrated**

Item No.	Description	wt.	Each
480 75	R30 - 160mm	.126	\$19.40

Carbon steel. Nickel-plated finish.



Made in Germany

www.wihatools.com

## Interchangeable Tweezers with Heat Protected Plastic Handle

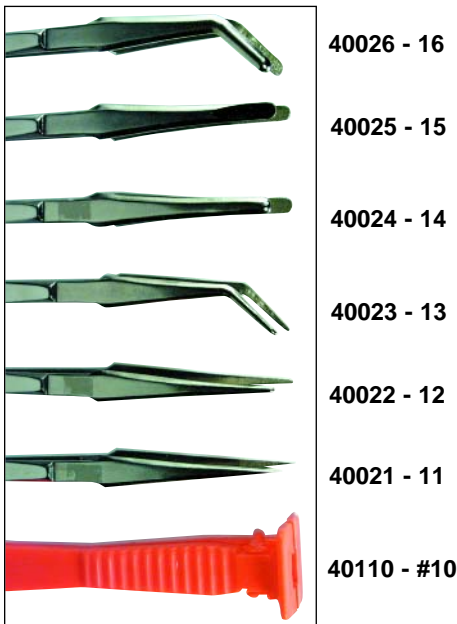
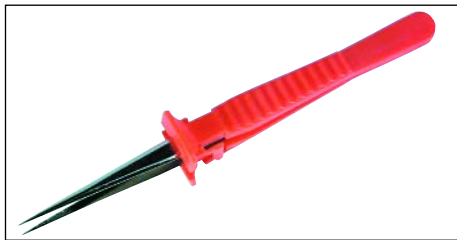

40026 - 16

40025 - 15

40024 - 14

40023 - 13

40022 - 12

40021 - 11

40110 - #10

### Molded Handle With Closure Lock

Item No.	Description	wt.	Each
401 10	#10 Handle - 100mm	.064	\$5.30

Plastic Molded handle

### Long Pointed With Fine Serrations

Item No.	Description	wt.	Each
400 21	11 SA - 145mm	.086	\$14.20

Stainless steel, anti-magnetic and acid resistant.  
Brushed Finish tweezers made from Vommelaloy.

### Long Round Tip With Fine Serrations

Item No.	Description	wt.	Each
400 22	12 SA - 145mm	.088	\$13.70

Stainless steel, anti-magnetic and acid resistant.  
Brushed Finish tweezers made from Vommelaloy.

### Long Round Tip With Fine Serrations

Item No.	Description	wt.	Each
400 23	13 SA - 145mm	.086	\$14.20

Stainless steel, anti-magnetic and acid resistant.  
Brushed Finish tweezers made from Vommelaloy.

## Blunt Round Tip Fine Serrations

Item No.	Description	wt.	Each
400 24	14 SA - 145mm	.086	\$13.50

Stainless steel, anti-magnetic and acid resistant.  
Brushed Finish tweezers made from Vommelaloy.

## Blunt Flat Tips With Fine Serrations

Item No.	Description	wt.	Each
400 25	15 SA - 145mm	.088	\$15.00

Stainless steel, anti-magnetic and acid resistant.  
Brushed Finish tweezers made from Vommelaloy.

## Blunt Round Tip Bent 30°, Fine Serrations

Item No.	Description	wt.	Each
400 26	16 SA - 145mm	.088	\$14.70

Stainless steel, anti-magnetic and acid resistant.  
Brushed Finish tweezers made from Vommelaloy.



### 5 Piece Set In Pouch

Item No.	Description	wt.	Each
400 90	5 pc. set in pouch	.282	\$61.20

Set includes: 40021, 40023, 40024, 40026, 40110  
Stainless steel, anti-magnetic and acid resistant.  
Brushed Finish tweezers made from Vommelaloy.

## Inspection Mirrors All Stainless Detachable & Boilable

### Mirrors-Clean Room Quality

For Visual Checks and Fault Finding at Inaccessible Locations

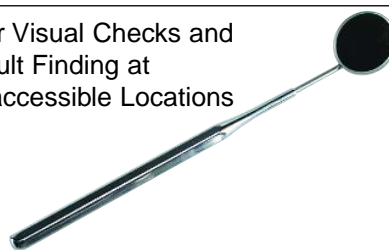

Magnifying, Boilable



Natural Finish, Stainless Steel

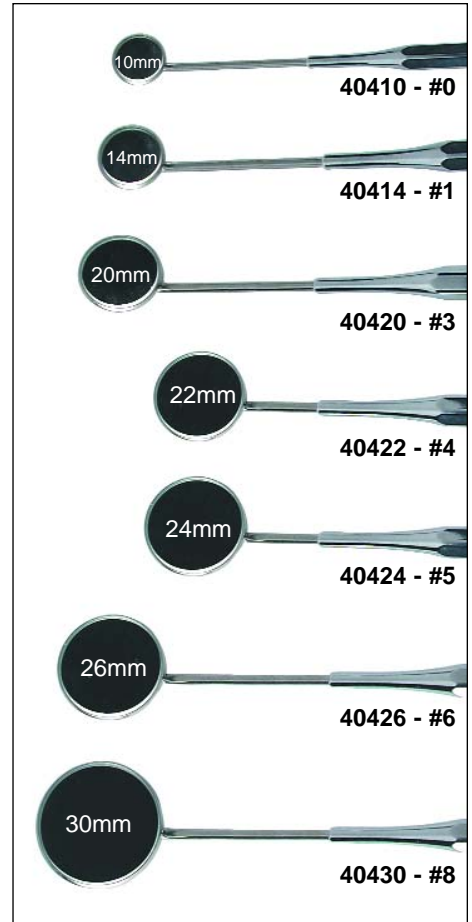

### Inspection Mirror - Stainless 10mm

Item No.	Description	wt.	Each
404 10	#0 IM - 185mm	.09	\$29.98

### Inspection Mirror - Stainless 14mm

Item No.	Description	wt.	Each
404 14	#1 IM - 200mm	.09	\$29.98

### Inspection Mirror - Stainless 20mm

Item No.	Description	wt.	Each
404 20	#3 IM - 205mm	.09	\$29.98

### Inspection Mirror - Stainless 22mm Short Stem

Item No.	Description	wt.	Each
404 22	#4 IM - 175mm	.10	\$18.98

### Inspection Mirror - Stainless 24mm Short Stem

Item No.	Description	wt.	Each
404 24	#5 IM - 175mm	.10	\$18.98

### Inspection Mirror - Stainless 26mm

Item No.	Description	wt.	Each
404 26	#6 IM - 215mm	.10	\$29.98

### Inspection Mirror - Stainless 30mm

Item No.	Description	wt.	Each
404 30	#8 IM - 215mm	.10	\$29.98





Made in Germany

Toll Free: (800) 494-6104

# Professional Quality Excavators & Probes

## One Piece All Stainless Excavators



### Excavators-Clean Room Quality

- Can Be Used as Mini-Spatulas
- For Work on PCB's, Modeling
- Surgical Stainless Steel
- Polished Finish
- Single Piece Construction

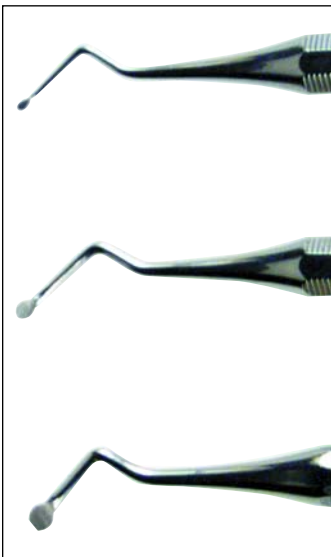

43251-3225.1-39

43252-3225.2-35

43253-3225.3-31

### 1mm Excavator

Item No.	Description	wt.	Each
432 51	3225.1-39 - 165mm	.094	\$29.98

Stainless steel, polished finish.

### 2mm Excavator

Item No.	Description	wt.	Each
432 52	3225.2-35 - 165mm	.094	\$29.98

Stainless steel, polished finish.

### 2.5mm Excavator

Item No.	Description	wt.	Each
432 53	3225.3-31 - 165mm	.096	\$29.98

Stainless steel, polished finish.

## One Piece All Stainless Probes

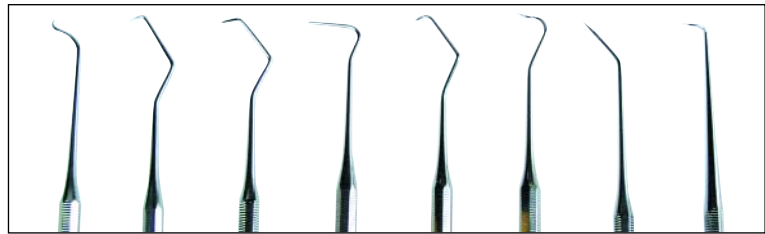

43221 43222 43223 43224 43225 43226 43227 43228

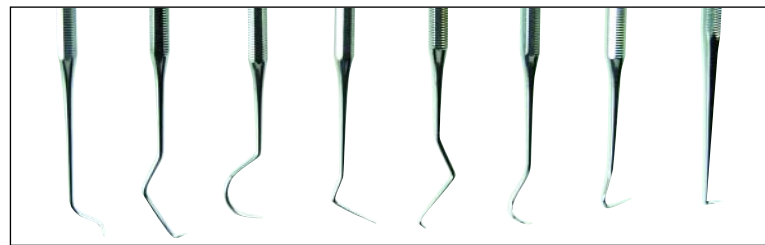

### All Stainless Single Piece Construction-Clean Room Quality



### Stainless Steel Probe

Item No.	Description	wt.	Each
432 21	3220.1-07 Probe - 170mm	.074	\$21.98

Stainless steel, polished finish.



### Stainless Steel Probe

Item No.	Description	wt.	Each
432 24	3220.4-16 Probe - 170mm	.074	\$21.98

Stainless steel, polished finish.



### Stainless Steel Probe

Item No.	Description	wt.	Each
432 22	3220.3-06 Probe - 170mm	.074	\$21.98

Stainless steel, polished finish.



### Stainless Steel Probe

Item No.	Description	wt.	Each
432 25	3220.5-09 Probe - 170mm	.074	\$21.98

Stainless steel, polished finish.



### Stainless Steel Probe

Item No.	Description	wt.	Each
432 23	3220.3-05 Probe - 170mm	.074	\$21.98

Stainless steel, polished finish.



### Stainless Steel Probe

Item No.	Description	wt.	Each
432 26	3220.6-10 Probe - 170mm	.074	\$21.98

Stainless steel, polished finish.



Made in Germany

www.wihatools.com

# Professional Quality Probes & Hooks



## Stainless Steel Probe

Item No.	Description	wt.	Each
432 27	3220.7-17 Probe - 170mm .074		\$21.98

Stainless steel, polished finish.



## Stainless Steel Probe

Item No.	Description	wt.	Each
432 28	3220.8-02 Probe - 170mm .078		\$21.98

Stainless steel, polished finish.

## Probes-Clean Room Quality

- For Levering and Removing Components
- Stainless Steel, For Work on PCB's, Modeling
- Polished Finish



## Stainless Steel Straight Probe

Item No.	Description	wt.	Each
432 29	3220.9-09 Probe - 170mm .074		\$21.98

Stainless steel, polished finish.



## Soldering Hook

Item No.	Description	wt.	Each
432 30	3221 - 165mm	.074	\$19.98

Stainless steel, polished finish.

## One Piece All Stainless Hooks



## Sculpting & Scribing Hooks-Clean Room Quality

- Sharp Hooks For Cutting and Marking
- Surgical Stainless Steel
- Natural Finish
- For Work on PCB's, Modeling
- All Stainless Single Piece Construction

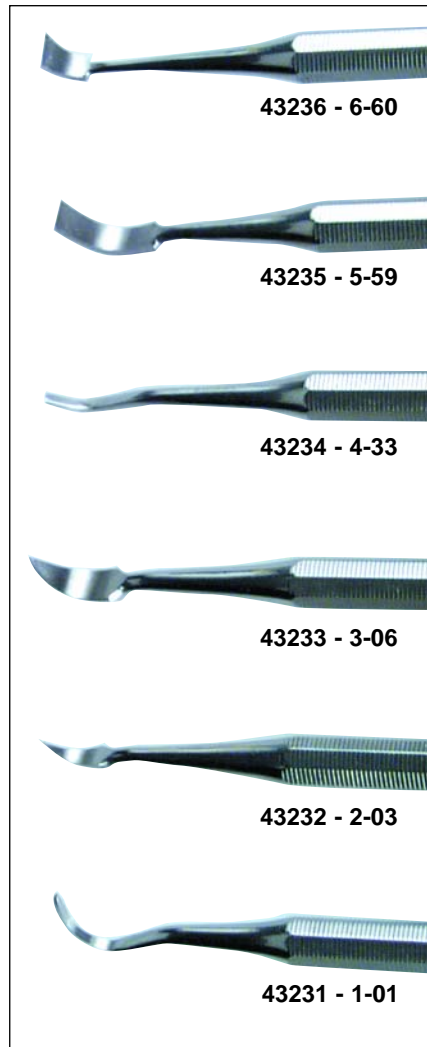

43236 - 6-60

43235 - 5-59

43234 - 4-33

43233 - 3-06

43232 - 2-03

43231 - 1-01

## Approx. 2mm Wide Short Tapered & Curved

Item No.	Description	wt.	Each
432 36	3230.6-60 Hook - 155mm .102		\$29.98

Stainless steel, Natural finish.

## Approx. 4mm Wide Squared & Curved

Item No.	Description	wt.	Each
432 35	3230.5-59 Hook - 155mm .100		\$29.98

Stainless steel, Natural finish.

## Approx. 2mm Wide Squared & Curved

Item No.	Description	wt.	Each
432 34	3230.4-33 Hook - 155mm .100		\$29.98

Stainless steel, Natural finish.

## Approx. 4.5mm Wide Sharp Pointed & Curved

Item No.	Description	wt.	Each
432 33	3230.3-06 Hook - 155mm .102		\$29.98

Stainless steel, Natural finish.

## Approx. 3mm Wide Pointed & Curved

Item No.	Description	wt.	Each
432 32	3230.2-03 Hook - 155mm .104		\$29.98

Stainless steel, Natural finish.

## Approx. 2mm Wide Sharp Curved Hook

Item No.	Description	wt.	Each
432 31	3230.1-01 Hook - 155mm .102		\$29.98

Stainless steel, Natural finish.



Made in Germany

Toll Free: (800) 494-6104

**Wiha Bits & Bit Sets Index**

	Description	Page
	Topra Ratchet Bit Sets	147
	XSelector Bit Sets	148
	6 in 1 Multi Bit Sets	149
	Bit-Selectors	150-151,152
	Power Bit-Selectors	151-152
	Security Bits Collector	153
	Bit Holders	154
	Dura Bits	155
	Diamond Bits	155
	TiN Coated Bits	156
	Slotted Bits	157
	Phillips Bits	158-159
	Torx Bits	160-162
	Security Torx Bits	161-162
	TorxPlus Bits	161
	Torx Align Bits	161
	MagicRing Bits	162
	Hex Bits	163
	Security Hex Bits	163
	Pozidriv Bits	164
	Square Bits	164-165
	Torq Set Bits	165
	Tri Wing Bits	165
	Spanner Bits	165
	ClicFix Bit Holders	166
	Nut Setters	166
	Torx Sockets	167-169
	Hex Sockets	167-169

**Wiha Topra Ratchet Handle**

**282 Sets** Topra Ratchet Sets With Bit Holder and Bits, 12 Pc.  
1/4" Magnetic Bit Holder and 10 hardened bits of special chrome-vanadium-molybdenum tool steel.



**282 96** Slotted/Phillips/ **TORX** Topra Ratchet Bit Set, 13 Pc.  
Set includes Topra Handle, Magnetic bit holder and the following bits: **lbs.**

↓ **Slotted Sizes:** 5.5, 6.5, 8.0mm .69

**Phillips Sizes:** 0, 1, 2, 3 **Each**

**TORX** Sizes: T10, T15, T20 **\$40.76**

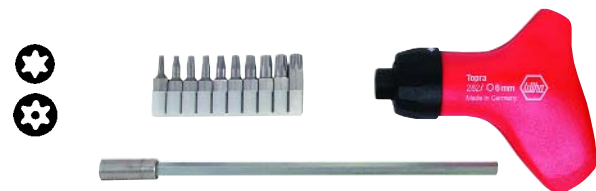

**282 95** **TORX** Topra Ratchet Bit Set, 12 Pc.  
Set includes Topra Handle, Magnetic bit holder and the following bits: **lbs.**

**TORX** Sizes: T7, T8, T9, T10, T15, .65

T20, T25, T27, T30, T40 **Each \$45.88**

**282 97** Tamper Resistant **TORX** Topra Ratchet Bit Set, 12 Pc.  
Set includes Topra Handle, Magnetic bit holder and the following bits: **lbs.**

**Tamper Resistant TORX** Sizes: .65

TR7, TR8, TR9, TR10, TR15, **Each**

TR20, TR25, TR27, TR30, TR40 **\$51.98**

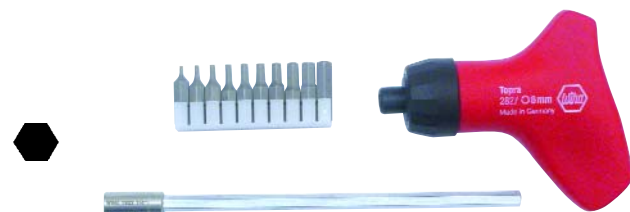

**282 98** Hex Inch Topra Ratchet Bit Set, 12 Pc.  
Set includes Topra Handle, Magnetic bit holder and the following bits: **lbs.**

**Hex Inch Sizes:** .65

1/16, 5/64, 3/32, 7/64, 1/8, **Each**

9/64, 5/32, 3/16, 7/32, 1/4" **\$45.86**

**282 99** Hex Metric Topra Ratchet Bit Set, 10 Pc.  
Set includes Topra Handle, Magnetic bit holder and the following bits: **lbs.**

**Hex Metric Sizes:** .65

1.5, 2.0, 2.5, 3.0, 4.0, 5.0, 6.0, 8.0mm **Each \$45.80**



Made in Germany

www.wihatools.com

Wiha XSelector Bit Sets

It couldn't be smaller!  
Compact size and easy bit selection make the NEW XSelector an ideal maintenance tool

Easy bit access with hinged cover



Pocket Sized  
3 1/8" x 2 1/8" x 1/2"

Sets include Clicfix quick release holder



794 Sets XSelector Bit Sets

These handy sets include 10 hardened bits of chrome-vanadium-molybdenum steel. 1/4" Quick Release holder can be used in power tools. Quick bit access through integrated bit-clip.

794 47 XSelector Bit Set With Tamper Resistant TORX® Bits

Set Includes ClicFix Quick Release Holder  $\frac{1}{4}$  lbs.  
and the following 10 bits: .27  
 ⚙️ TR TORX® Sizes: TR7, TR8, TR9, TR10, TR15, TR20, TR25, TR27, TR30, TR40 Each \$29.98



794 43 XSelector Bit Set With Slotted, Phillips, and TORX® Bits

Set Includes ClicFix Quick Release Holder  $\frac{1}{4}$  lbs.  
and the following 10 bits: .27  
 ⚙️ Slotted Sizes: 5.5, 6.5, 8.0mm  
 ⚙️ Phillips Sizes: 0, 1, 2, 3 Each  
 ⚙️ TORX® Sizes: T10, T15, T20 \$19.98



794 50 XSelector Bit Set With Security TORXPlus® Bits

Set Includes ClicFix Quick Release Holder  $\frac{1}{4}$  lbs.  
and the following 7 bits: .24  
 ⚙️ TORXPlus® Sizes: IPR8, PR10, IPR15, IPR20, IPR25, IPR27, IPR30 Each Call



794 45 XSelector Bit Set With TORX® Bits

Set Includes ClicFix Quick Release Holder  $\frac{1}{4}$  lbs.  
and the following 10 bits: .29  
 ⚙️ TORX® Sizes: T7, T8, T9, T10, T15, T20, T25, T27, T30, T40 Each \$23.98



794 46 XSelector Bit Set With Hex Inch Bits

Set Includes ClicFix Quick Release Holder  $\frac{1}{4}$  lbs.  
and the following 10 bits: .27  
 ⚙️ Hex Inch Sizes: 1/16, 5/64, 3/32, 7/64, 1/8, 9/64, 5/32, 3/16, 7/32, 1/4" Each \$21.98



Made in Germany

Toll Free: (800) 494-6104

Wiha Multi-Bit Screwdrivers

Six Tools in One!

1/4" Magnetic Bit Holder directs magnetism through the bit for powerful screw holding.

Cap rotates eliminating palm blisters. Allows one handed turning & frees other hand for positioning the work piece.

Ergonomic Powerhandle for maximum comfort and exceptional torque.

Cap snaps on & off. Doesn't unscrew while you're using the tool.

Chambered Bit Storage in the handle. Turn the transparent selector to the bit you need. No time wasted fumbling or sorting to find the right bit.



**380 Sets** Multi-Bit Screwdriver Sets with Wiha Powerhandle, cellulose-acetate, impact resistant. Snap-lock rotatable cap. Chambered bit holder equipped with transparent selector and 6 bits. 1/4" Bit holder, stainless steel. Shaft chrome-vanadium-molybdenum steel, hardened, chrome-plated. Packaged in clear blister package. Blade Length = 120mm (4.7"). Overall Length = 230mm (9").



**380 06** Slotted/Phillips Multi-Bit Screwdriver with Wiha Powerhandle and insulated shaft.

Set includes the following 1/4" bits:			
↓	Slotted Sizes:	5.5, 6.5, 8.0mm	lbs. Each
+	Phillips Sizes:	1, 2, 3	.39 \$16.80

**380 07** Slotted/Phillips/Square Multi-Bit Screwdriver with Wiha Powerhandle and insulated shaft.

Set includes the following 1/4" bits:			
↓	Slotted Sizes:	6.5, 8.0mm	lbs. Each
+	Phillips Sizes:	1, 2	.39 \$17.80
□	Square Sizes:	1, 2	

Insulation meets VDE, ASTM & IEC specifications



**380 03** TORX® Multi-Bit Screwdriver with Wiha Powerhandle.

Set includes the following 1/4" bits:			
⊗	TORX® Sizes:	T5, T6, T7, T8, T9, T10	lbs. Each
			.36 \$19.68

**380 04** TORX® Multi-Bit Screwdriver with Wiha Powerhandle.

Set includes the following 1/4" bits:			
⊗	TORX® Sizes:	T8, T9, T10, T15, T20, T25	lbs. Each
			.36 \$18.68

**380 08** TORX® Multi-Bit Screwdriver with Wiha Powerhandle.

Set includes the following 1/4" bits:			
⊗	TORX® Sizes:	T10, T15, T20, T25, T30, T40	lbs. Each
			.36 \$19.36

**380 09** Tamper Resistant TORX® Screwdriver with Wiha Powerhandle.

Set includes the following 1/4" bits:			
⊗	Tamper Resistant TORX® Sizes:	TR7, TR8, TR9, TR10, TR15, TR20	lbs. Each
			.36 \$22.98

**380 10** Tamper Resistant TORX® Screwdriver with Wiha Powerhandle.

Set includes the following 1/4" bits:			
⊗	Tamper Resistant TORX® Sizes:	TR10, TR15, TR20, TR25, TR30, TR40	lbs. Each
			.36 \$22.98



**380 01** Inch Hex Multi-Bit Screwdriver with Wiha Powerhandle.

Set includes the following 1/4" bits:			
⬠	Hex Inch Sizes:	1/8, 9/64, 5/32, 3/16, 7/32, 1/4"	lbs. Each
			.36 \$18.34

**380 02** Metric Hex Multi-Bit Screwdriver with Wiha Powerhandle.

Set includes the following 1/4" bits:			
⬠	Hex Metric Sizes:	2.0, 2.5, 3.0, 4.0, 5.0, 6.0mm	lbs. Each
			.36 \$18.34



Made in Germany

www.wihatools.com

### Wiha Bit Selectors

Compact size and easy bit selection make the Bit Selector an ideal maintenance tool.



Plastic storage box is compact, durable and light weight

Slide out drawer allows quick bit access and secure storage



Molded hex cavity in box end. Magnetic adapter fits into opening so tool case can be used as a handle on quick fastening jobs.

1/4" Magnetic Adapter fits all standard 1/4" bits

#### 792 Sets Bit-Selector Sets

These handy sets include 10 hardened bits of chrome-vanadium-molybdenum steel. 1/4" magnetic bit holder can be used in power tools. Plastic storage box is compact, durable and light weight. Molded hex cavity turns box into handle for quick fastening jobs. Quick bit access with slide out drawer. Packaged in clear blister pack.



#### 792 43 Bit-Selector With Slotted, Phillips, and TORX® Bits

Set includes magnetic 1/4" bit holder and the following 10 bits:

- ↓ Slotted Sizes: 5.5, 6.5, 8.0mm .31
- ⊕ Phillips Sizes: 0, 1, 2, 3 Each
- ⊛ TORX® Sizes: T10, T15, T20 \$15.98

#### 792 48 Bit-Selector With Slotted, Phillips, and Square Bits

Set includes magnetic 1/4" bit holder and the following 10 bits:

- ↓ Slotted Sizes: 5.5, 6.5, 8.0mm .32
- ⊕ Phillips Sizes: 0, 1, 2, 3 Each
- Square Sizes: 1, 2, 3 \$15.98

#### 792 49 Bit Selector With Slotted/Phillips/Pozidriv®/Square and TORX® Bits

Set includes magnetic 1/4" bit holder and the following 10 bits:

- ↓ Slotted Sizes: 5.5, 6.5mm .31
- ⊕ Phillips Sizes: 1, 2
- ⊕ Pozidriv® Sizes: 1, 2
- Square Sizes: 1, 2 Each
- ⊛ TORX® Sizes: T10, T15 \$15.98



#### 792 45 Bit-Selector With TORX® Bits

Set includes magnetic 1/4" bit holder and the following 10 bits:

	lbs.	Each
⊛ TORX® Sizes: T7, T8, T9, T10, T15, T20, T25, T27, T30, T40	.32	\$17.98

#### 792 47 Bit-Selector With Tamper Resistant TORX® Bits

Set includes magnetic 1/4" bit holder and the following 10 bits:

	lbs.	Each
⊛ Tamper Resistant TORX® Sizes: TR7, TR8, TR9, TR10, TR15, TR20, TR25, TR27, TR30, TR40	.32	\$24.98



#### 792 46 Bit-Selector With Hex Inch Bits

Set includes magnetic 1/4" bit holder and the following 10 bits:

	lbs.	Each
⬢ Hex Inch Sizes: 1/16, 5/64, 3/32, 7/64, 1/8, 9/64, 5/32, 3/16, 7/32, 1/4"	.32	\$17.30

#### 792 56 Bit-Selector With Hex Metric Bits

Set includes magnetic 1/4" bit holder and the following 8 bits:

	lbs.	Each
⬢ Hex Metric Sizes: 1.5, 2.0, 2.5, 3.0, 4.0, 5.0, 6.0, 8.0mm	.30	\$17.30



#### 792 50 Bit-Selector With Phillips Bits

Set includes magnetic 1/4" bit holder and the following 10 bits:

	lbs.	Each
⊕ Phillips Size: 2 (10 pc.)	.32	\$10.98

#### 792 51 Bit-Selector With Phillips Bits

Set includes magnetic 1/4" bit holder and the following 10 bits:

	lbs.	Each
⊕ Phillips Size: 0 (2 pc.), 1 (2 pc.), 2 (4 pc.), 3 (2 pc.)	.32	\$11.98



Made in Germany

Toll Free: (800) 494-6104

Wiha Insert Bit Selectors



<b>716 90</b>	<b>Bit-Selector with TorxPlus® bits</b>	
	Set includes magnetic 1/4" bit holder	↔ lbs.
	and the following 10 bits:	
	<b>TorxPlus® Sizes:</b>	.31
	IP7, IP8, IP9, IP10, IP15, IP20, IP25	Each
	IP27, IP30, IP40	\$23.98



<b>710 90</b>	<b>Bit-Selector with Slotted, Phillips &amp; Hex 1/4" Bits</b>	
	Set includes magnetic 1/4" ClicFix bit holder	↔ lbs.
	and the following 9 bits:	
	<b>Slotted Sizes:</b> 4.5, 5.5, 6.5	.25
	<b>Phillips Sizes:</b> 1, 2, 3	Each
	<b>Hex Sizes:</b> 1/8, 5/32, 3/16	\$23.48



<b>792 90</b>	<b>Bit-Selector Case</b>	↔ lbs.
	Empty bit selector case, holds 10 bits	Each
	and 1/4" bit holder (not included).	.10 \$4.10

Wiha Power Bit Selectors

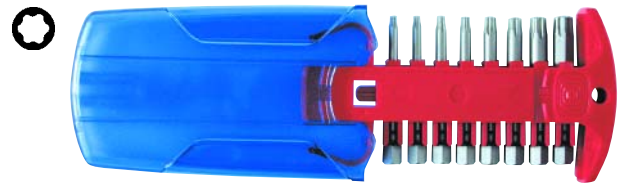

<b>746 90</b>	<b>Bit-Selector with TORXPlus® power bits - 2" Power Bits</b>	
	Set includes the following 8 bits:	↔ lbs.
	<b>TorxPlus® Sizes:</b>	.31
	IP8, IP9, IP10, IP15, IP20	Each
	IP25, IP30, IP40	\$33.98

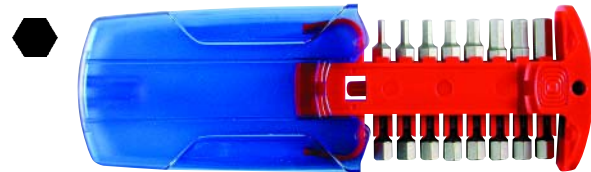

<b>743 97</b>	<b>Bit-Selector with Hex Inch Power Bits - 2" Power Bits</b>	
	Set Includes The Following 8 Bits:	↔ lbs.
	<b>Hex Inch Sizes:</b>	.38
	3/32, 7/64, 1/8, 9/64, 5/32,	Each
	3/16, 7/32, 1/4	\$23.40



<b>749 10</b>	<b>Power Bit-Selector with Slotted/Phillips/Square bits</b>	
	Includes:	↔ lbs.
	<b>Slotted:</b> 5.5, 6.5	Each
	<b>Phillips:</b> 1, 2, 3	.38 \$17.98
	<b>Square:</b> 1, 2, 3	

<b>749 20</b>	<b>Power Bit-Selector with Slotted/Phillips &amp; TORX® bits</b>	
	Includes:	↔ lbs.
	<b>Slotted:</b> 5.5, 6.5	Each
	<b>Phillips:</b> 1, 2, 3	.37 \$19.98
	<b>TORX®:</b> T15, T20, T25	

<b>749 30</b>	<b>Power Bit-Selector with TORX® bits</b>	
	Includes:	↔ lbs.
	<b>TORX®:</b> T8, T9, T10, T15,	Each
	T20, T25, T30, T40	.36 \$24.44

<b>749 40</b>	<b>Power Bit-Selector with Tamper Resistant TORX® bits</b>	
	Includes:	↔ lbs.
	<b>Tamper Resistant TORX®:</b>	Each
	TR8, TR10, TR15, TR20, TR25,	.36 \$31.98
	TR27, TR30, TR40	



Made in Germany

www.wihatools.com

**Wiha Insert and Power Bit-Selectors**



<b>710 94</b>	<b>Bit-Selector With Dura Insert 1/4" Bits</b>	
	Set Includes Magnetic 1/4" Bit Holder	↔
	& The Following 10 Bits:	lbs.
↓	Slotted Sizes: 5.5, 6.5, 8.0mm	.29
+	Phillips Sizes: 1, 2, 3	Each
⊕	TORX® Sizes: T10, T15, T20, T25	\$57.98

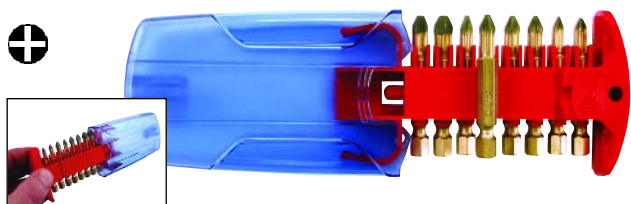

<b>741 93</b>	<b>Bit-Selector With Dura Power Bits - 2" Power Bits</b>	
	↔	
+	Phillips Sizes:	lbs. .37
	#1 - qty 2, #2 - qty 4, #3 - qty 2	Each \$48.98



<b>711 96</b>	<b>PokitPak - Phillips TiN Coated Insert Bits In Molded Case -</b>	
	Set Includes 6 - 1/4" Insert Bits	↔
+	Phillips Sizes: 2 of each - 1, 2, 3	lbs. Each
		.31 \$13.70



<b>711 98</b>	<b>PokitPak - Slotted &amp; Phillips Insert Bits In Molded Case -</b>	
	Set Includes 6 - 1/4" Insert Bits & Magnetic Bit Holder	
↓	Slotted: 4.5, 6.5mm	↔ lbs. Each
+	Phillips: 0, 1, 2, 3	.15 \$6.60

**MagicRing**

Screw Holding



<b>713 99</b>	<b>Bit-Selector With Metric &amp; Inch MagicRing Insert 1/4" Bits</b>	
	Set Includes Magnetic 1/4" Bit Holder	↔
	& The Following 10 Bits:	lbs.
⬢	No Ball End	.46
	Hex Metric Sizes: 3.0, 4.0, 5.0, 6.0	Each
	Hex Inch Sizes: 1/8, 9/64, 5/32, 3/16, 7/32, 1/4"	\$30.50

Screw Holding

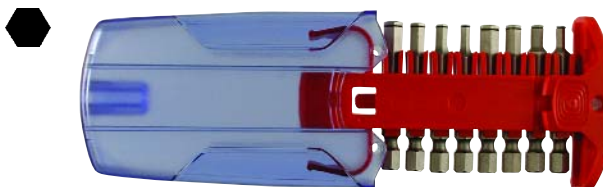
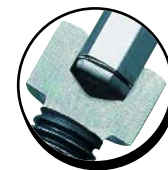

<b>743 99</b>	<b>Bit-Selector With Metric &amp; Inch MagicRing 1/4" Power Bits</b>	
	2" Power Bits	↔
		lbs.
⬢	No Ball End	.40
	Hex Metric Sizes: 3.0, 4.0, 5.0, 6.0	Each
	Hex Inch Sizes: 1/8, 5/32, 3/16, 1/4"	\$29.54





Made in Germany

Toll Free: (800) 494-6104

Wiha Security Bits Collector

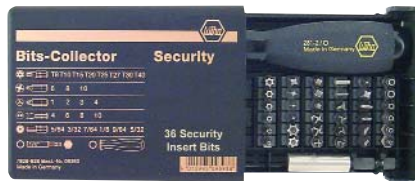

**719 90** Bits Collector with Security Bits in Tamper Resistant TORX®, Triwing, Torq Set, Spanner, Tamper Resistant Hex, Slotted, Phillips, Pozidriv®, and Square bits. 39 Piece Set

Set includes: Handle, 1/4" magnetic bit holder, 1/4" Bit holding socket adapter and the following 1/4" bits:

⊗ Tamper Resistant TORX® Sizes:

TR8, TR10, TR15, TR20, TR25, TR27, TR30, TR40

⌚ Triwing Sizes: 1, 2, 3, 4

⊕ Torq Set Sizes: 6, 8, 10

⊖ Spanner Sizes: 4, 6, 8, 10

⊗ Tamper Resistant Hex Sizes: 5/64, 3/32, 7/64, 1/8, 9/64, 5/32

⬆️ ⬇️ ⬆️ Slotted Sizes: 6.5, 8.0mm

⊕ Phillips Sizes: 1, 2

⊕ Pozidriv® Sizes: 0, 1, 2, 3

⊖ Square Sizes: 1, 2, 3

⚖️ lbs. 1.03 Each \$66.98

**710 95** Bits Collector with Insert Bits Phillips and Hex Bits 51 Piece Set

Set includes: Clicfix quick release bit holder and the following 1/4" bits:

⊕ Phillips Sizes:

10 each of #1 & #2, 5 of #3

⊖ Hex Sizes:

10 each of 1/8 & 3/16, 5 of 5/32

⚖️ lbs. Each \$58.94



**719 91** Bits Collector with Security Bits in Tamper Resistant TORX®, Triwing, Torq Set, Spanner, Tamper Resistant Hex, Slotted, Phillips, Pozidriv®, and Square bits. 39 Piece Set

Set includes: Handle, Clicfix quick release bit holder 1/4" Bit holding socket adapter and the following 1/4" bits:

⊗ Tamper Resistant TORX® Sizes:

TR8, TR10, TR15, TR20, TR25, TR27, TR30, TR40

⌚ Triwing Sizes: 1, 2, 3, 4

⊕ Torq Set Sizes: 6, 8, 10

⊖ Spanner Sizes: 4, 6, 8, 10

⊗ Tamper Resistant Hex Sizes: 5/64, 3/32, 7/64, 1/8, 9/64, 5/32

⬆️ ⬇️ ⬆️ Slotted Sizes: 6.5, 8.0mm

⊕ Phillips Sizes: 1, 2

⊕ Pozidriv® Sizes: 0, 1, 2, 3

⊖ Square Sizes: 1, 2, 3

⚖️ lbs. 1.04 Each \$69.98

Wiha ClicFix Quick Release Holder



**380 30** ClicFix Quick Release Holder

Blade high alloy chrome-vanadium-molybdenum steel, hardened, chrome-plated. Wiha Powerhandle high quality plastic, impact resistant.

Item	⊖	⊕	⊖	⊕	⚖️	📦	Each
No.	Size	mm	Inch	mm	Inch	lbs	pkg.
380 30	1/4"	120	4.7	230	9.0	.27	10 \$24.98



**380 33** Slotted, Phillips & ClicFix Quick Release Holder 7 Pc. Set

with Wiha Powerhandle and CVM steel, hardened shaft.

Set includes the following 1/4" bits:

⬆️ ⬇️ ⬆️ Slotted Sizes:	6.5, 8.0mm	lbs.	Each
⊕ Phillips Sizes:	0, 1, 2, 3	.43	\$27.98



Made in Germany

www.wihatools.com

Wiha Bit Holders



**388 00 Bit Holder With Wiha T-handle**

Magnetic, holds bit and screw. Retainer out of stainless steel. Hex shaft chrome-vanadium-molybdenum steel, nickel-plated. Wiha-T-handle high quality plastic, impact resistant.

Item								
No.	Size	mm	Inch	mm	Inch	lbs.	pkg.	Each
388 00	1/4"	150	6.0	80	3.0	.18	1	\$7.98



**384 1/4" Bit Holding Screwdrivers, With Wiha-SoftFinish® Handle**

Ergonomic cushion grip, magnetic, holds bit and screw. Retainer out of stainless steel. Shaft chrome-vanadium-molybdenum steel, nickel-plated.

Item								
No.	Size	mm	Inch	mm	Inch	lbs.	pkg.	Each
384 50	1/4"	125	5.0	240	9.46	.23	1	\$10.50
384 60	1/4"	300	11.8	400	15.69	.37	1	\$17.98



**526 50 1/4" Bit holding Screwdriver, With Wiha-MicroFinish Handle**

Non-slip grip, magnetic, holds bit and screw. Retainer out of stainless steel. Shaft chrome-vanadium-molybdenum steel, nickel-plated. Wiha-MicroFinish handle, cellulose-acetate, impact resistant, non-slip, oil and grease resistant.

Item								
No.	Size	mm	Inch	mm	Inch	lbs.	pkg.	Each
526 50	1/4"	125	5.0	225	8.9	.24	1	\$13.98



**484 01 1/4" Bit holding Screwdriver, With Wiha-Ergo 3K Handle**

Magnetic, holds bit and screw. Retainer out of stainless steel. Shaft CVM tool steel, nickel plated.

Item								
No.	Size	mm	Inch	mm	Inch	lbs.	pkg.	Each
484 01	1/4"	125	5.0	144	5.6	.24	1	\$7.98

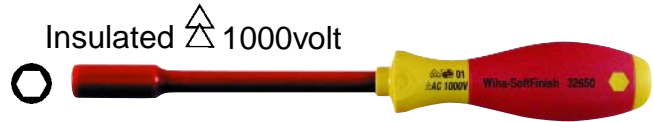

**326 50 Retaining Ring Bit Holding Screwdriver, With Wiha-SoftFinish® Handle**

Blade high alloy CVM steel, hardened, black finish. Insulation molded directly onto blade. Holds 1/4" drive bits.

Item								
No.	Size	mm	Inch	mm	Inch	lbs.	pkg.	Each
326 50	1/4"	60	2.4	164	6.5	.06	1	\$11.98

Insulation meets VDE, ASTM & IEC specifications



**380 15 Magnetic Bit Holder, 1/4", Wiha-Powerhandle**

cellulose-acetate, impact resistant. Snap-lock rotatable cap. Chambered bit holder equipped with transparent selector for easy selection of bits. 1/4" bit holder, stainless steel, magnetic, holds bit and screw. Shaft CVM steel. Cavity holds up to 6 bits. (bits not included)

Item								
No.	Size	mm	Inch	mm	Inch	lbs.	pkg.	Each
380 15	1/4"	120	4.7	230	9.0	.25	1	\$11.06



**380 25 Magnetic Bit Holder, 1/4", Wiha-Powerhandle, Insulated,**

cellulose-acetate, impact resistant. Snap-lock rotatable cap. Chambered bit holder equipped with transparent selector for easy selection of bits. 1/4" bit holder, shielded, magnetic, holds bit and screw. Cavity holds up to 6 bits. (bits not included)

Item								
No.	Size	mm	Inch	mm	Inch	lbs.	pkg.	Each
380 25	1/4"	120	4.7	230	9.0	.26	1	\$13.18

Insulation meets VDE, ASTM & IEC specifications



**668 50 1/4" Bit Holding Screwdriver, With Wiha-Protturn Precision handle.**

Magnetic, holds bit and screw. Retainer out of stainless steel. Shaft chrome-vanadium-molybdenum steel, nickel-plated.

Item								
No.	Size	mm	Inch	mm	Inch	lbs.	pkg.	Each
668 50	1/4"	60	2.36	170	6.7	.07	1	\$6.50



Made in Germany

Toll Free: (800) 494-6104

**Dura Torsion Insert and Power Bits**

With the Dura bit Wiha has again proved it's power of innovation. The extra hard, elastic Quattro Torsion bit is equipped with an extremely wear resistant tungsten carbide coating that grips the screw head.

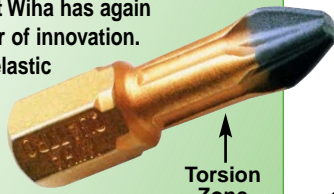

Torsion Zone

Positive location in the screw head with decrease of:

- necessary pressure forces
- working time
- costs
- wear & tear of bits & screw heads
- anti-cam-out effect

Carbide Coated



**711 Dura Bits, Phillips, 1/4"**

Item	+	—	
No.	mm	mm	Each
711 11	1	25	\$4.06
711 12	2	25	\$4.06
711 13	3	25	\$4.06



**712 Dura Bits, Pozidriv, 1/4"**

Item	+	—	
No.	mm	mm	Each
712 11	1	25	\$4.06
712 12	2	25	\$4.06
712 13	3	25	\$4.06



**741 Dura Phillips Power Bits, 1/4" Hex Drive, Length 2.0"/50mm**

Item	+	—	
No.	Size	mm	Each
741 41	1	50	\$5.50
741 42	2	50	\$5.50
741 43	3	50	\$5.50



**742 Dura Pozidriv Power Bits, 1/4" Hex Drive, Length 2.0"/50mm**

Item	+	—	
No.	Size	mm	Each
742 41	1	50	\$5.50
742 42	2	50	\$5.50
742 43	3	50	\$5.50



**710 Dura Bits, Slotted, 1/4"**

Item	+	+	+	+	—	
No.	mm	Inch	mm	Inch	mm	Each
710 10	0.6	.024	4.5	.177	25	\$4.80
710 11	0.8	.030	5.5	.216	25	\$4.80
710 12	1.0	.039	5.5	.216	25	\$4.80
710 13	1.2	.039	6.5	.255	25	\$4.80
710 14	1.2	.039	8.0	.315	25	\$4.80



**715 Dura Bits, TORX, 1/4"**

Item	+	—	
No.	mm	mm	Each
715 74	T10	25	\$6.20
715 76	T15	25	\$6.20
715 78	T20	25	\$6.20
715 80	T25	25	\$6.20
715 82	T30	25	\$6.20
715 84	T40	25	\$6.20

**Diamond Torsion Insert and Power Bits**

Diamond bits supplement Wiha's range of high-quality special bits. When used with machines, the increased tool life of the Wiha Diamond bit reduces cost.



Torsion Zone

- High wear resistance
- Micro particle coating with sapphire and diamond contents
- Optimized torsion zone

Reduction of:

- pressure forces to be applied
- wear and tear of bit and screw head
- working time
- working costs
- Cam-out effect

The ideal bit even for the most difficult of applications.



**710 Diamond Bits, Slotted, 1/4"**

Item	+	+	+	+	—	
No.	mm	Inch	mm	Inch	mm	Each
710 20	4.5	.177	0.6	.024	25	\$4.60
710 21	5.5	.216	0.8	.030	25	\$4.60
710 22	5.5	.216	1.0	.039	25	\$4.60
710 23	6.5	.255	1.2	.039	25	\$4.60
710 24	8.0	.315	1.2	.063	25	\$4.60



**711 Diamond Bits, Phillips, 1/4"**

Item	+	—	
No.	mm	mm	Each
711 81	1	25	\$3.90
711 82	2	25	\$3.90
711 83	3	25	\$3.90



**712 Diamond Bits, Pozidriv, 1/4"**

Item	+	—	
No.	mm	mm	Each
712 21	1	25	\$3.90
712 22	2	25	\$3.90
712 23	3	25	\$3.90



**715 Diamond Bits, TORX, 1/4"**

Item	+	—	
No.	mm	mm	Each
715 16	T10	25	\$5.70
715 17	T15	25	\$5.70
715 18	T20	25	\$5.70
715 19	T25	25	\$5.70
715 21	T30	25	\$5.70
715 22	T40	25	\$5.70



**741 Diamond Phillips Power Bits, 1/4" Hex Drive, Length 2.0"/50mm**

Item	+	—	
No.	Size	mm	Each
741 61	1	50	\$5.20
741 62	2	50	\$5.20
741 63	3	50	\$5.20





Made in Germany

Toll Free: (800) 494-6104

# Slotted Bits

The ideal multi-purpose bits for all around quality and performance.



High resistant to wear and tear for a long tool life

Impact resistant modified chrome-vanadium-molybdenum, tool steel, hardened

Suitable for all applications  
Hardness HRC 59-61  
Suitable for both manual and machine applications

## Wiha Slotted Insert Bits and Power Bits



**710 Slotted Insert Bits, 1/4" Hex Drive, Length 25mm/.984"**

Item	↑	⊕	⊖	⊗	▬	
No.	mm	Inch	mm	Inch	pkg.	Each
710 01	4.5	.177	0.6	.024	10	\$ .80
710 04	5.5	.216	0.8	.030	10	\$ .80
710 02	6.5	.255	1.2	.039	10	\$ .80
710 03	8.0	.315	1.6	.063	10	\$ .80



**743 Slotted and Phillips Double End Bits, 1/4" Hex Drive, Length 2.36"/60mm**

Item	↑	⊕	⊖	⊗	▬	
No.	Size	Size	mm	pkg.	Each	
743 03	6-8	x 1	60	10	\$1.84	
743 06	8-10	x 2	60	10	\$1.84	
743 09	10-12	x 3	60	10	\$1.84	



**710 55 Slotted Insert Bit Packs, 1" CVM**  
S2 modified tool steel. Extra hard with natural finish. Exact fit machined tips. 3 pc. bit pack.

**710 55 Set includes the following bits:**

Slotted Sizes:	Each
5.5, 6.5, 8.0 x 1" (25mm)	\$2.84



**740 Slotted Power Bits, 1/4" Hex Drive, Length 2.0"/50mm**

Item	↑	⊕	⊖	⊗	▬	
No.	mm	Inch	mm	Inch	pkg.	Each
740 03	3.0	.118	0.5	.020	10	\$1.46
740 06	3.5	.139	0.6	.024	10	\$1.46
740 09	4.0	.157	0.5	.020	10	\$1.46
740 10	4.0	.157	0.8	.030	10	\$1.46
740 12	4.5	.177	0.6	.024	10	\$1.46
740 15	5.5	.216	0.8	.032	10	\$1.46
740 18	6.5	.255	1.2	.039	10	\$1.46
740 21	8.0	.315	1.2	.039	10	\$2.68
740 23	8.0	.315	1.6	.063	10	\$3.24



**710 Slotted Insert Bit Packs, 1" CVM S2**  
modified tool steel.

Item	↑	⊕	⊖	⊗	▬	
No.	mm	Size	Inch	mm	2 Bit Pack	
710 51	0.6	4.5	.177	25	\$2.28	
710 52	0.8	5.5	.216	25	\$2.28	
710 53	1.2	6.5	.255	25	\$2.28	
710 54	1.6	8.0	.315	25	\$2.28	



**740 50 Slotted Power Bit Packs, 2" CVM**  
S2 modified tool steel. Extra hard with natural finish. Exact fit machined tips. 3 pc. bit pack.

**740 50 Set includes the following bits:**

Slotted Sizes:	Each
4.5, 5.5, 6.5 x 2" (50mm)	\$8.12



Made in Germany

www.wihatools.com

# Phillips Bits

The ideal multi-purpose bits for all around quality and performance.

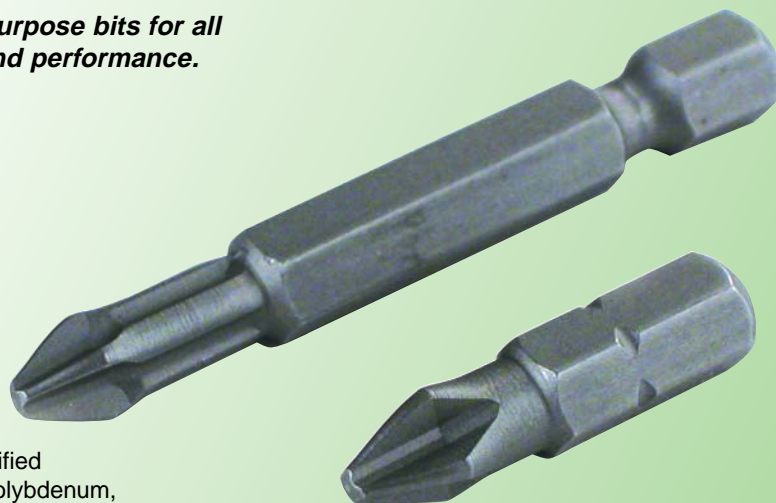

Impact resistant modified chrome-vanadium-molybdenum, tool steel, hardened

High resistant to wear and tear for a long tool life

Suitable for all applications  
Hardness HRC 59-61  
Suitable for both manual and machine applications

## Wiha Phillips Insert Bits and Power Bits



### 711 Phillips Insert Bits, 1/4"

Item	+	—	—	—
No.	Size	mm	pkg.	Each
711 00	0	25	10	\$.48
711 01	1	25	10	\$.48
711 02	2	25	10	\$.40
711 03	3	25	10	\$.48

### 711 Phillips Insert Bit Bulk Packs, 1/4"

Item	+	—	—	—
No.	Size	mm	pkg.	Each
711 25	2	25	25 piece	\$9.98
711 50	2	25	50 piece	\$19.50
711 99	2	25	100 piece	\$36.90



### 714 Phillips Double End Bits. 1/4" Hex Drive, Length 2.36"/60mm

Item	+	+	—	—	
No.	Size	Size	mm	pkg.	Each
714 04	1	x 1	60	10	\$2.40
714 14	2	x 2	60	10	\$2.40
714 24	3	x 3	60	10	\$2.40



### 741 Phillips Power Bits. 1/4" Hex Drive, Length 2.0"/50mm

Item	+	—	—	—
No.	Size	mm	pkg.	Each
741 03	1	50	10	\$.86
741 12	2	50	10	\$.86
741 24	3	50	10	\$.86



### 792 50 Bit-Selector With Phillips Bits Set includes magnetic 1/4" bit holder and the following 10 bits:

Phillips Size:	lbs.	Each
2 (10 pc.)	.32	\$10.98

### 792 51 Bit-Selector With Phillips Bits - Set includes magnetic 1/4" bit holder and the following 10 bits:

Phillips:	lbs.	Each
0 (2 pc.), 1 (2 pc.)	.32	\$11.98
2 (4 pc.), 3 (2 pc.)		



### 743 Slotted and Phillips Double End Bits. 1/4" Hex Drive, Length 2.36"/60mm

Item	+	+	—	—	
No.	Size	Size	mm	pkg.	Each
743 03	6-8	x 1	60	10	\$1.84
743 06	8-10	x 2	60	10	\$1.84
743 09	10-12	x 3	60	10	\$1.84



### 741 Phillips Power Bits. 1/4" Hex Drive, Length 2.75"/70mm

Item	+	—	—	—
No.	Size	mm	pkg.	Each
741 06	1	70	10	\$1.52
741 15	2	70	10	\$1.52
741 27	3	70	10	\$1.52



Made in Germany

Toll Free: (800) 494-6104

Wiha Phillips Insert Bits and Power Bits



**741 Phillips Power Bits. 1/4" Hex Drive, Length 3.5"/90mm**

Item	+	—	■	
No.	Size	mm	pkg.	Each
741 09	1	90	10	\$1.84
741 18	2	90	10	\$1.84
741 30	3	90	10	\$1.84



**741 Phillips Power Bits. 1/4" Hex Drive, Length 4.33"/110mm**

Item	+	—	■	
No.	Size	mm	pkg.	Each
741 11	1	110	10	\$2.10
741 21	2	110	10	\$2.10
741 31	3	110	10	\$2.10



**741 Phillips Power Bits. 1/4" Hex Drive, 127mm/5"**

Item	+	—	■	
No.	Size	mm	pkg.	Each
741 13	1	127	10	\$2.20
741 23	2	127	10	\$2.20
741 33	3	127	10	\$2.20



**741 Phillips Power Bits. 1/4" Hex Drive, 150mm**

Item	+	—	■	
No.	Size	mm	pkg.	Each
741 16	1	150	10	\$2.30
741 26	2	150	10	\$2.30
741 36	3	150	10	\$2.30



**711 Phillips Insert Bit Packs, 1"**

CVM S2 modified tool steel

Item	+	—	
No.	Size	mm	2 Bit Pack
711 49	0	25	\$1.52
711 51	1	25	\$1.52
711 52	2	25	\$1.52
711 53	3	25	\$1.52



**710 56 Slotted/Phillips Insert Bit Packs, 1"**

CVM S2 modified tool steel. Extra hard with natural finish, exact fit machined tips. 6 pc. bit pack.

**710 56 Set includes the following bits:**

●	<b>Slotted Sizes:</b>	
		5.5, 6.5, 8.0 x 1" (25mm)
+	<b>Phillips Sizes:</b>	Each
		1, 2, 3 x 1" (25mm) \$4.06



**711 96 PokitPak - Phillips TiN Coated Insert Bits In Molded Case -**

Set Includes 6 - 1/4" Insert Bits

**Phillips Sizes:** 2 of each - 1, 2, 3

lbs. .31 Each \$13.70



**711 54 Phillips Insert Bit Packs, 1" CVM**

S2 modified tool steel. Extra hard with natural finish. Exact fit machined tips. 3 pc. bit pack.

**711 54 Set includes the following bits:**

+	<b>Phillips Sizes:</b>	Each
		1, 2, 3 x 1" (25mm) \$2.02



**741 50 Phillips Power Bit Packs, 2" CVM**

S2 modified tool steel. Extra hard with natural finish. Exact fit machined tips. 3 pc. bit pack.

**741 50 Set includes the following bits:**

+	<b>Phillips Sizes:</b>	Each
		1, 2, 3 x 2" (50mm) \$3.52



**711 55 Phillips Insert Bit Packs, 1" CVM**

S2 modified tool steel. Extra hard with natural finish. Exact fit machined tips. 6 pc. bit pack.

**711 55 Set includes the following bits:**

+	<b>Phillips Sizes:</b>	Each
		6 pieces 2 x 1" (25mm) \$3.46



Made in Germany

www.wihatools.com

# TORX® Bits

*The ideal multi-purpose bits for all around quality and performance.*

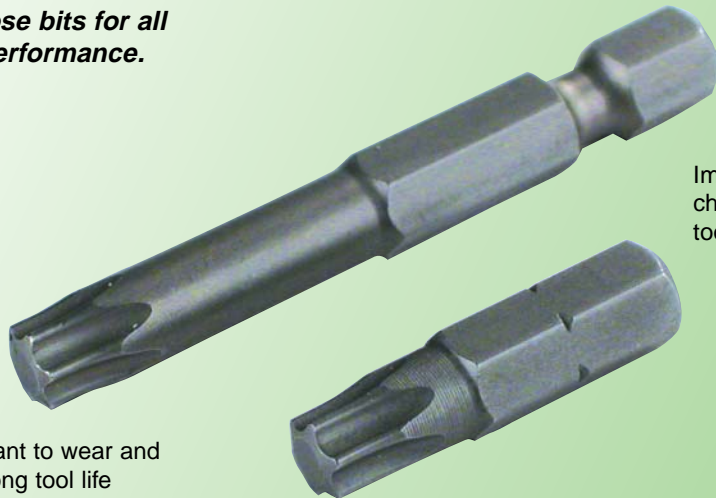

High resistant to wear and tear for a long tool life

Impact resistant modified chrome-vanadium-molybdenum, tool steel, hardened

Suitable for all applications  
Hardness HRC 59-61  
Suitable for both manual and machine applications



## 715 TORX® Bits, 1/4"

Item No.	Size	mm	pkg.	Each
715 05	T5	25	10	\$1.20
715 06	T6	25	10	\$1.20
715 07	T7	25	10	\$1.20
715 08	T8	25	10	\$1.20
715 09	T9	25	10	\$1.20
715 10	T10	25	10	\$.98
715 15	T15	25	10	\$.98
715 20	T20	25	10	\$.98
715 25	T25	25	10	\$.98
715 27	T27	25	10	\$.98
715 30	T30	25	10	\$.98
715 40	T40	25	10	\$1.20



## 745 TORX® Power Bits. 1/4" Hex Drive, Length 2.0"/50mm

Item No.	Size	mm	pkg.	Each
745 11	T6	50	10	\$2.56
745 12	T7	50	10	\$2.56
745 13	T8	50	10	\$2.56
745 17	T9	50	10	\$2.56
745 19	T10	50	10	\$2.56
745 21	T15	50	10	\$2.56
745 23	T20	50	10	\$2.56
745 29	T25	50	10	\$2.56
745 31	T27	50	10	\$2.56
745 33	T30	50	10	\$2.56
745 35	T40	50	10	\$2.56



## 745 TORX® Power Bits. 1/4" Hex Drive, Length 3.5"/90mm

Item No.	Size	mm	pkg.	Each
745 63	T6	90	10	\$3.86
745 65	T7	90	10	\$3.86
745 67	T8	90	10	\$3.86
745 69	T9	90	10	\$3.86
745 71	T10	90	10	\$3.86
745 73	T15	90	10	\$3.86
745 75	T20	90	10	\$3.86
745 77	T25	90	10	\$3.86
745 79	T27	90	10	\$3.86
745 81	T30	90	10	\$3.86
745 83	T40	90	10	\$3.86



## 744 TORX® Double End Bits. 1/4" Hex Drive, Length 2.56"/65mm

Item No.	Size	Size	mm	pkg.	Each
744 11	T6	T6	65	10	\$2.68
744 13	T7	T7	65	10	\$2.68
744 15	T8	T8	65	10	\$2.68
744 17	T9	T9	65	10	\$2.68
744 19	T10	T10	65	10	\$2.54
744 21	T15	T15	65	10	\$2.54
744 23	T20	T20	65	10	\$2.54
744 29	T25	T25	65	10	\$2.54
744 31	T27	T27	65	10	\$2.54
744 33	T30	T30	65	10	\$2.54
744 35	T40	T40	65	10	\$2.54



## 745 TORX® Power Bits. 1/4" Hex Drive, Length 2.75"/70mm

Item No.	Size	mm	pkg.	Each
745 36	T6	70	10	\$3.26
745 38	T7	70	10	\$3.26
745 42	T8	70	10	\$3.26
745 44	T9	70	10	\$3.26
745 46	T10	70	10	\$3.26
745 48	T15	70	10	\$3.26
745 51	T20	70	10	\$3.26
745 53	T25	70	10	\$3.26
745 56	T27	70	10	\$3.26
745 58	T30	70	10	\$3.26
745 61	T40	70	10	\$3.26



## 745 TORX® Power Bits. 1/4" Hex Drive, Length 6.0"/152mm

Item No.	Size	mm	pkg.	Each
745 86	T10	152	10	\$6.12
745 87	T15	152	10	\$6.12
745 88	T20	152	10	\$6.12
745 89	T25	152	10	\$6.12
745 90	T27	152	10	\$6.12
745 91	T30	152	10	\$6.12





Made in Germany

Toll Free: (800) 494-6104

Wiha TORX® Insert Bits and Power Bits

Torx®  
Align



715 TORX® Align Bits, 1/4"				
Item				
No.	Size	mm	pkg.	Each
715 36	T6	25	10	\$1.48
715 37	T7	25	10	\$1.48
715 38	T8	25	10	\$1.48
715 39	T9	25	10	\$1.48
715 41	T10	25	10	\$1.48
715 42	T15	25	10	\$1.48
715 43	T20	25	10	\$1.48
715 44	T25	25	10	\$1.48
715 45	T27	25	10	\$1.48
715 46	T30	25	10	\$1.48
715 47	T40	25	10	\$1.48

\*Also Known As Torx Wedge Fit

Tamper  
Resistant  
Torx®



701 TR TORX® Bits, Tamper Resistant, 1/4"				
Item				
No.	Size	mm	pkg.	Each
701 27	TR7	25	10	\$1.82
701 28	TR8	25	10	\$1.82
701 29	TR9	25	10	\$1.82
701 35	TR10	25	10	\$1.62
701 39	TR15	25	10	\$1.62
701 42	TR20	25	10	\$1.62
701 48	TR25	25	10	\$1.62
701 60	TR27	25	10	\$1.62
701 63	TR30	25	10	\$1.62
701 68	TR40	25	10	\$1.82

Torx® Plus



716 TORXPlus® Insert Bits, 1/4" Hex, 1" OAL				
Item				
No.	Size	mm	pkg.	Each
716 03	IP3	25	10	Call
716 04	IP4	25	10	Call
716 05	IP5	25	10	Call
716 06	IP6	25	10	\$1.50
716 07	IP7	25	10	\$1.50
716 08	IP8	25	10	\$1.50
716 09	IP9	25	10	\$1.22
716 10	IP10	25	10	\$1.22
716 15	IP15	25	10	\$1.22
716 20	IP20	25	10	\$1.22
716 25	IP25	25	10	\$1.22
716 27	IP27	25	10	\$1.22
716 30	IP30	25	10	\$1.50
716 40	IP40	25	10	\$1.50



747 TORX® Align Bits, 1/4" Hex Drive, Length 2.0"/50mm				
Item				
No.	Size	mm	pkg.	Each
747 11	T6	50	10	\$3.34
747 14	T7	50	10	\$3.34
747 17	T8	50	10	\$3.34
747 21	T9	50	10	\$3.34
747 24	T10	50	10	\$3.34
747 28	T15	50	10	\$3.34
747 32	T20	50	10	\$3.34
747 36	T25	50	10	\$3.34
747 39	T27	50	10	\$3.34
747 42	T30	50	10	\$3.34

\*Also Known As Torx Wedge Fit



705 TORX® Power Bits, Tamper Resistant, 1/4" Hex Drive, Length 2.0"/50mm				
Item				
No.	Size	mm	pkg.	Each
705 07	TR7	50	10	\$3.46
705 08	TR8	50	10	\$3.46
705 09	TR9	50	10	\$3.46
705 10	TR10	50	10	\$3.46
705 15	TR15	50	10	\$3.46
705 20	TR20	50	10	\$3.46
705 25	TR25	50	10	\$3.46
705 27	TR27	50	10	\$3.46
705 30	TR30	50	10	\$3.46
705 40	TR40	50	10	\$3.46
705 45	TR45	50	10	\$3.96
705 50	TR50	50	10	\$3.96
705 55	TR55	50	10	\$3.96



746 TORXPlus® Power Bits, 1/4" Hex, 2" OAL				
Item				
No.	Size	mm	pkg.	Each
746 02	IP6	50	10	Call
746 03	IP7	50	10	Call
746 04	IP8	50	10	\$3.18
746 08	IP9	50	10	\$3.18
746 12	IP10	50	10	\$3.18
746 16	IP15	50	10	\$3.18
746 20	IP20	50	10	\$3.18
746 24	IP25	50	10	\$3.18
746 28	IP27	50	10	\$3.18
746 32	IP30	50	10	\$3.18
746 36	IP40	50	10	\$3.18



Made in Germany

www.wihatools.com

Wiha TORX® Insert Bits and Power Bits



716 TORXPlus® Security Insert Bits, 1/4" Hex, 1" OAL

Item	No.	Size	mm	pkg.	Each
	716 48	IPR8	25	10	Call
	716 50	IPR10	25	10	Call
	716 52	IPR15	25	10	Call
	716 54	IPR20	25	10	Call
	716 56	IPR25	25	10	Call
	716 57	IPR27	25	10	Call
	716 58	IPR30	25	10	Call
	716 60	IPR40	25	10	Call

IPR - 5 point Security TorPlus bits are available for special order to authorized OEM's and their certified service agents. You must submit a written certification/documentation to purchase this product. Call our customer service department: (800) 494-6104 for information.



701 Tamper Resistant Torx® Insert Bit Packs, 1" CVM S2 modified tool steel

Item	No.	Size	mm	2 Bit Pack
	701 50	TR7	25	\$4.18
	701 51	TR8	25	\$4.18
	701 52	TR9	25	\$4.18
	701 53	TR10	25	\$3.78
	701 54	TR15	25	\$3.78
	701 55	TR20	25	\$3.78
	701 56	TR25	25	\$3.78
	701 57	TR27	25	\$3.78
	701 58	TR30	25	\$3.78
	701 59	TR40	25	\$4.18



725 TORX® Bits, 5/16"

Item	No.	Size	mm	pkg.	Each
	725 40	T40	35	10	\$2.54
	725 45	T45	35	10	\$2.54
	725 50	T50	35	10	\$2.54
	725 55	T55	35	10	\$4.50



715 71 Torx® Insert Bit Packs, 1" CVM S2 modified tool steel. Extra hard with natural finish. Exact fit machined tips. 6 pc. bit pack.

715 71 Set includes the following bits:

Torx® Sizes:	Each
T15, T20, T25, T27,	Each
T30, T40 x 1" (25mm)	\$6.60

715 70 Torx® Insert Bit Packs, 1" CVM S2 modified tool steel. Extra hard with natural finish. Exact fit machined tips. 6 pc bit pack.

715 70 Set includes the following bits:

Torx® Sizes:	Each
T5, T6, T7, T8, T9,	Each
T10 x 1" (25mm)	\$10.18



715 Torx® Insert Bit Packs, 1" CVM S2 modified tool steel

Item	No.	Size	mm	2 Bit Pack
	715 50	T5	25	\$3.04
	715 51	T6	25	\$3.04
	715 52	T7	25	\$3.04
	715 53	T8	25	\$3.04
	715 54	T9	25	\$3.04
	715 55	T10	25	\$2.52
	715 56	T15	25	\$2.52
	715 57	T20	25	\$2.52
	715 58	T25	25	\$2.52
	715 59	T27	25	\$2.52
	715 60	T30	25	\$2.52
	715 61	T40	25	\$3.04

Wiha MagicRing Insert/Power Bits

Screw Holding Hex Bits



713 MagicRing Metric Insert Bits, 1/4"

Item	No.	Size	mm	pkg.	Each
	713 04	3.0	25	10	\$2.80
	713 07	4.0	25	10	\$2.80
	713 10	5.0	25	10	\$2.80
	713 11	6.0	25	10	\$2.80

713 MagicRing Inch Insert Bits, 1/4"

Item	No.	Size	mm	pkg.	Each
	713 43	1/8	25	10	\$2.80
	713 46	9/64	25	10	\$2.80
	713 49	5/32	25	10	\$2.80
	713 52	3/16	25	10	\$2.80
	713 54	7/32	25	10	\$2.80
	713 58	1/4	25	10	\$2.80



743 MagicRing Metric Power Bits, 1/4"

Item	No.	Size	mm	pkg.	Each
	743 01	3.0	50	10	\$3.30
	743 05	4.0	50	10	\$3.30
	743 07	5.0	50	10	\$3.30
	743 19	6.0	50	10	\$3.30

743 MagicRing Inch Power Bits, 1/4"

Item	No.	Size	mm	pkg.	Each
	743 69	1/8	50	10	\$3.30
	743 71	9/64	50	10	\$3.30
	743 73	5/32	50	10	\$3.30
	743 75	3/16	50	10	\$3.30
	743 77	7/32	50	10	\$3.30
	743 79	1/4	50	10	\$3.30



Made in Germany

Toll Free: (800) 494-6104

# Hex Bits

The ideal multi-purpose bits for all around quality & performance.

High resistant to wear and tear for a long tool life

Impact resistant modified CVM, tool steel, hardened



Suitable for all applications Hardness HRC 59-61 Suitable for both manual and machine applications

See MagicRing Ring Screw Holding Hex Bits on Page 17



### 713 Hex Metric Insert Bits, 1/4"

Item No.	Size	mm	pkg.	Each
713 03	1.5	25	10	\$1.08
713 06	2.0	25	10	\$1.08
713 08	2.5	25	10	\$1.08
713 09	3.0	25	10	\$1.08
713 12	4.0	25	10	\$1.08
713 15	5.0	25	10	\$1.08
713 18	6.0	25	10	\$1.08
713 21	8.0	25	10	\$2.34
713 24	10.0	25	10	\$2.34



### 713 Hex Inch Insert Bits, 1/4"

Item No.	Size	mm	pkg.	Each
713 29	.050	25	10	\$1.08
713 26	1/16	25	10	\$1.08
713 28	5/64	25	10	\$1.08
713 30	3/32	25	10	\$1.08
713 33	7/64	25	10	\$1.08
713 36	1/8	25	10	\$1.08
713 39	9/64	25	10	\$1.08
713 42	5/32	25	10	\$1.08
713 45	3/16	25	10	\$1.08
713 48	7/32	25	10	\$1.08
713 51	1/4	25	10	\$1.08
713 53	5/16	25	10	\$2.34
713 56	3/8	25	10	\$2.34



### 743 Hex Inch Power Bits, 1/4" Hex Drive, Length 2.0"/50mm

Item No.	Size	mm	pkg.	Each
743 11	3/32	50	10	\$2.96
743 12	7/64	50	10	\$2.96
743 13	1/8	50	10	\$2.96
743 14	9/64	50	10	\$2.96
743 15	5/32	50	10	\$2.96
743 16	3/16	50	10	\$2.96
743 17	7/32	50	10	\$2.96
743 18	1/4	50	10	\$2.96

### 743 Hex Metric Power Bits, 1/4" Hex Drive, Length 2.0"/50mm

Item No.	Size	mm	pkg.	Each
743 25	2.5	50	10	\$2.96
743 30	3.0	50	10	\$2.96
743 40	4.0	50	10	\$2.96
743 50	5.0	50	10	\$2.96
743 60	6.0	50	10	\$2.96
743 80	8.0	50	10	\$2.96



### 719 Tamper Resistant Hex In Insert Bits, 1/4"

Item No.	Size	mm	pkg.	Each
719 30	5/64	25	10	\$1.84
719 32	3/32	25	10	\$1.84
719 34	7/64	25	10	\$1.84
719 36	1/8	25	10	\$1.84
719 38	9/64	25	10	\$1.84
719 40	5/32	25	10	\$1.84
719 60	1/4	25	10	\$1.84



### 719 Tamper Resistant Hex Metric Insert Bits, 1/4"

Item No.	Size	mm	pkg.	Each
719 41	2.5	25	10	\$1.84
719 42	3.0	25	10	\$1.84
719 43	4.0	25	10	\$1.84
719 44	5.0	25	10	\$1.84
719 45	6.0	25	10	\$1.84
719 46	8.0	25	10	\$3.08



### 713 Hex Inch Insert Bit Packs, 1" CVM S2 modified tool steel

Item No.	Size	mm	2 Bit Pack
713 60	1/16	25	\$2.62
713 61	5/64	25	\$2.62
713 62	3/32	25	\$2.62
713 63	7/64	25	\$2.62
713 64	1/8	25	\$2.62
713 65	9/64	25	\$2.62
713 66	5/32	25	\$2.62
713 67	3/16	25	\$2.62
713 68	7/32	25	\$2.62
713 69	1/4	25	\$2.62

### 719 Tamper Resistant Hex Inch Insert Bit Packs, 1" CVM S2 modified tool steel

Item No.	Size	mm	2 Bit Pack
719 70	5/64	25	\$4.26
719 71	3/32	25	\$4.26
719 72	7/64	25	\$4.26
719 73	1/8	25	\$4.26
719 74	9/64	25	\$4.26
719 75	5/32	25	\$4.26

### 719 Tamper Resistant Hex Metric Insert Bit Packs, 1" CVM S2 modified tool steel

Item No.	Size	mm	2 Bit Pack
719 80	2.5	25	\$4.26
719 81	3.0	25	\$4.26
719 82	4.0	25	\$4.26
719 83	5.0	25	\$4.26
719 84	6.0	25	\$4.26



### 713 96 Hex Inch Insert Bit Packs, 1" CVM S2 modified tool steel. Extra hard with natural finish. Exact fit machined tips. 6 pc. bit pack.

**713 96 Set includes the following bits:**

Hex Inch Sizes:	Each
1/16, 3/32, 1/8, 5/32	Each
3/16, 1/4" x 1" (25mm)	\$7.18

### 713 97 Hex Metric Insert Bit Packs, 1" CVM S2 modified tool steel. Extra hard with natural finish. Exact fit machined tips. 6 pc bit pack.

**713 97 Set includes the following bits:**

Hex Metric Sizes:	Each
2.0, 2.5, 3.0, 4.0, 5.0, 6.0	\$7.18



Made in Germany

www.wihatools.com

# Specialty Bits

The ideal multi-purpose tool to meet high requirements in terms of both quality and performance.

High resistant to wear and tear for a long tool life

Impact resistant modified CVM, tool steel, hardened

Suitable for all applications  
Hardness HRC 59-61  
Suitable for both manual and machine applications



## PoziDriv® Bits



### 712 PoziDriv® Insert Bits, 1/4"

Item No.	Size	mm	pkg.	Each
712 00	0	25	10	\$.60
712 01	1	25	10	\$.60
712 02	2	25	10	\$.60
712 03	3	25	10	\$.60



### 742 PoziDriv® Power Bits. 1/4" Hex Drive, Length 2.0"/50mm

Item No.	Size	mm	pkg.	Each
742 03	1	50	10	\$1.12
742 12	2	50	10	\$1.12
742 21	3	50	10	\$1.12



### 742 PoziDriv® Power Bits. 1/4" Hex Drive, Length 3.5"/90mm

Item No.	Size	mm	pkg.	Each
742 07	1	90	10	\$3.36
742 16	2	90	10	\$3.36
742 25	3	90	10	\$3.36



### 712 PoziDriv® Insert Bit Packs, 1"

CVM S2 modified tool steel

Item No.	Size	mm	2 Bit Pack
712 50	0	25	\$1.54
712 51	1	25	\$1.54
712 52	2	25	\$1.54
712 53	3	25	\$1.54



### 712 54 PoziDriv® Insert Bit Packs, 1" CVM

S2 modified tool steel. Extra hard with natural finish. Exact fit machined tips. 3 pc. bit pack.

Item No.	Set includes the following bits:	Each
712 54	PoziDriv® Sizes: 1, 2, 3 x 1" (25mm)	\$2.04

## Square Bits



### 718 Square Insert Bits, 1/4"

Item No.	Size	mm	pkg.	Each
718 01	1	25	10	\$.68
718 02	2	25	10	\$.68
718 03	3	25	10	\$.68



### 748 Square Power Bits. 1/4" Hex Drive, Length 2.0"/50mm

Item No.	Size	mm	pkg.	Each
748 03	1	50	10	\$1.00
748 06	2	50	10	\$1.00
748 09	3	50	10	\$1.00



### 748 90 Square Power Bit Packs, 2.0" CVM

S2 modified tool steel. Extra hard with natural finish. Exact fit machined tips. 3 pc. bit pack.

Item No.	Set includes the following bits:	Each
748 90	Square Sizes: 1, 2, 3 x 2.0" (50mm)	\$4.18



Made in Germany

Toll Free: (800) 494-6104



**718 Square Insert Bit Packs, 1" CVM S2**

modified tool steel

Item	⊖	⊖		
No.	Size	mm	2 Bit Pack	
718 51	1	25	\$1.52	
718 52	2	25	\$1.52	
718 53	3	25	\$1.52	



**718 54 Square Insert Bit Packs, 1" CVM**

S2 modified tool steel. Extra hard with natural finish. Exact fit machined tips. 3 pc. bit pack.

**718 54 Set includes the following bits:**

⊖	Square Sizes:	Each
	1, 2, 3 x 1" (25mm)	\$2.52



**719 Torq Set Insert Bit Packs, 1"**

CVM S2 modified tool steel

Item	⊕	⊖		
No.	Size	mm	2 Bit Pack	
719 57	6	25	\$5.12	
719 58	8	25	\$5.12	
719 59	10	25	\$5.12	

**Tri Wing Bits**



**719 Triwing Insert Bits, 1/4"/25mm**

Item	⊕	⊖	⊖	
No.	Size	mm	pkg.	Each
719 00	0	25	10	\$2.14
719 01	1	25	10	\$2.14
719 02	2	25	10	\$2.14
719 03	3	25	10	\$2.14
719 04	4	25	10	\$2.14
719 05	5	25	10	\$2.14

**Spanner Bits**



**719 Spanner Insert Bits, 1/4"**

Item	⊖	⊖	⊖	
No.	Size	mm	pkg.	Each
719 14	4	25	10	\$1.56
719 16	6	25	10	\$1.56
719 18	8	25	10	\$1.56
719 20	10	25	10	\$1.56



**719 Spanner Insert Bit Packs, 1"**

CVM S2 modified tool steel

Item	⊖	⊖		
No.	Size	mm	2 Bit Pack	
719 63	4	25	\$3.66	
719 64	6	25	\$3.66	
719 65	8	25	\$3.66	
719 66	10	25	\$3.66	

**Torq Set Bits**



**719 Torq Set Insert Bits, 1/4"**

Item	⊕	⊖	⊖	
No.	Size	mm	pkg.	Each
719 07	4	25	10	\$2.14
719 09	5	25	10	\$2.14
719 06	6	25	10	\$2.14
719 08	8	25	10	\$2.14
719 10	10	25	10	\$2.14



**749 Triwing Power Bits, 1/4"/50mm**

Item	⊕	⊖	⊖	
No.	Size	mm	pkg.	Each
749 01	3	50	10	\$3.56
749 02	4	50	10	\$3.56
749 03	5	50	10	\$3.56
749 04	6	50	10	\$3.56



**749 Torq Set Power Bits, 1/4"/50mm**

Item	⊕	⊖	⊖	
No.	Size	mm	pkg.	Each
749 11	4	50	10	\$3.56
749 12	5	50	10	\$3.56
749 13	6	50	10	\$3.56
749 14	8	50	10	\$3.56
749 15	10	50	10	\$3.56



**719 Triwing Insert Bit Packs, 1"**

CVM S2 modified tool steel

Item	⊕	⊖		
No.	Size	mm	2 Bit Pack	
719 49	0	25	\$5.80	
719 50	1	25	\$5.80	
719 51	2	25	\$5.80	
719 52	3	25	\$5.80	
719 53	4	25	\$5.80	



**719 54 Triwing Insert Bit Packs, 1" CVM S2**

modified tool steel. Extra hard with natural finish. Exact fit machined tips. 3 pc. bit pack.

**719 54 Set includes the following bits:**

⊕	Triwing Sizes:	Each
	3, 4, 5 x 1" (25mm)	\$13.98



Made in Germany

www.wihatools.com

Wiha Bit Holders & Nut Setters

**Reduces Down Time • Increases Productivity**

**ClicFix!**  
Finally a true one handed quick change bit holder



- Internal bit lock mechanism
- Spring loaded - No fumbling
- One handed bit changes

**Pull Sleeve Back**



1

**Remove Bit**



2

**Insert New Bit**



3

**Pull Sleeve Forward To Lock**



4



714	ClicFix Bit Holder, Magnetic				
Item					
No.	Size	Size	mm	Inch	Each
714 90	1/4"	1/4"	60	2.4	\$10.16
714 91	1/4"	1/4"	75	2.9	\$13.98

Retaining Ring Bit Holders

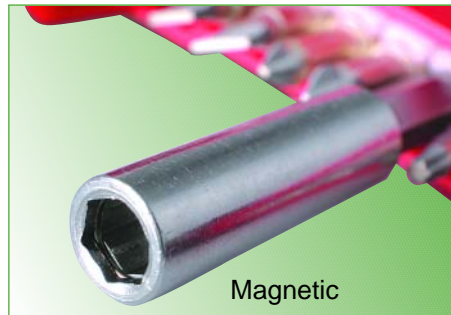

711	Universal Power Bit Holder, Magnetic, 1/4"				
Item					
No.	Size	Size	mm	Inch	Each
711 30	1/4"	1/4"	74	2.9	\$4.80
711 31	1/4"	1/4"	59	2.3	\$3.50



704	Nut Setters Standard. 1/4" Hex Metric			
Item				
No.	Size	mm	mm	Each
704 03	5.0	50		\$3.04
704 06	5.5	50		\$3.04
704 09	6.0	50		\$3.04
704 12	7.0	50		\$3.04
704 15	8.0	50		\$3.04
704 18	10.0	50		\$3.04
704 21	13.0	50		\$3.04

704	Nut Setters Standard. 1/4" Hex Inch			
Item				
No.	Size	mm	mm	Each
704 24	1/4	50		\$3.04
704 27	5/16	50		\$3.04
704 30	3/8	50		\$3.04



714	Bit Holder, Retaining Ring & Magnetic				
Item					
No.	Size	Size	mm	Inch	Each
714 31	1/4"	1/4"	60	2.4	\$4.36
714 33	1/4"	1/4"	67	2.6	\$4.98
714 35	1/4"	1/4"	100	3.9	\$6.60
714 37	1/4"	1/4"	150	5.9	\$8.86
714 39	1/4"	1/4"	200	7.8	\$11.80
714 41	1/4"	1/4"	253	10.0	\$14.98



704 Metric	Nut Setters Standard With Permanent Industrial Magnet. 1/4" Hex Metric Nut Setters.			
Item				
No.	Size	mm	mm	Each
704 33	5.0	50		\$5.06
704 36	5.5	50		\$5.06
704 39	6.0	50		\$5.06
704 42	7.0	50		\$5.06
704 45	8.0	50		\$5.06
704 48	10.0	50		\$5.06
704 51	13.0	50		\$5.06

704 Inch	1/4" Hex Inch Nut Setters			
Item				
No.	Size	mm	mm	Each
704 54	1/4	50		\$5.06
704 57	5/16	50		\$5.06
704 60	3/8	50		\$5.06



714	Screw Cap Bit Holder with O-Ring				
Item					
No.	Size	Size	mm	Inch	Each
714 93	1/4"	1/4"	76	3.0	\$6.98



Made in Germany

Toll Free: (800) 494-6104

**Wiha Sockets**



**761 TORX® Sockets. 1/4" Square Drive, Set Screw Replaceable Bit**

Item	Icon	No.	Size	mm	Each
761 07		T7	38	\$3.98	
761 09		T8	38	\$3.98	
761 11		T9	38	\$3.98	
761 13		T10	38	\$3.98	
761 17		T15	38	\$3.98	
761 19		T20	38	\$3.98	
761 21		T25	38	\$3.98	
761 23		T27	38	\$3.98	
761 29		T30	38	\$3.98	
761 31		T40	38	\$3.98	

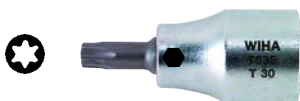

**763 TORX® Sockets. 3/8" Square Drive, Set Screw Replaceable Bit. 1/4" Bits**

Item	Icon	No.	Size	mm	Each
763 12		T9	42	\$3.98	
763 14		T10	42	\$3.98	
763 16		T15	42	\$3.98	
763 18		T20	42	\$3.98	
763 22		T25	42	\$3.98	
763 24		T27	42	\$3.98	
763 26		T30	42	\$3.98	
763 28		T40	42	\$3.98	



**763 TORX® Sockets. 3/8" Square Drive, Set Screw Replaceable Bit. 5/16" Bit. 2" OAL**

Item	Icon	No.	Size	mm	Each
763 46		T40	51	\$5.98	
763 48		T45	51	\$5.98	
763 52		T50	51	\$5.98	
763 54		T55	51	\$6.98	



**701 Tamper Resistant TORX® Sockets**  
3/8" Square drive, set screw replaceable bit. 1/4" bits. 2" OAL

Item	Icon	No.	Size	mm	Each
701 07		TR7	38	\$4.98	
701 08		TR8	38	\$4.98	
701 09		TR9	38	\$4.98	
701 10		TR10	38	\$4.98	
701 13		TR15	38	\$4.98	
701 15		TR20	38	\$4.98	
701 17		TR25	38	\$4.98	
701 19		TR27	38	\$4.98	
701 21		TR30	38	\$4.98	
701 23		TR40	38	\$4.98	



**339 Square Drive Socket Adapters, With Wiha-T-handle.** Blade CVM steel, hardened, chrome-plated, ball retainer. Wiha-T-handle high quality plastic, impact resistant.

Item	Icon	No.	Size	mm	Inch	mm	Inch	lbs.	Each
339 00		1/4	150	6.0	80	3.0	.23	\$7.90	
339 20		3/8	150	6.0	100	4.0	.23	\$13.80	
339 50		1/2	150	6.0	100	4.0	.53	\$18.90	

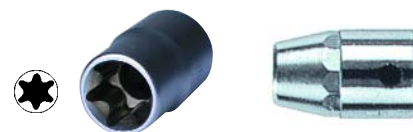

**773 TORX® External Sockets**  
1/4" Square drive socket. Heyco

Item	Icon	No.	Size	mm	Each
773 04		E4	25	\$5.08	
773 05		E5	25	\$5.08	
773 06		E6	25	\$5.08	
773 07		E7	25	\$5.08	
773 08		E8	25	\$5.08	
773 10		E10	25	\$5.08	

**773 TORX® External Sockets**  
3/8" Square drive socket. Heyco

Item	Icon	No.	Size	mm	Each
773 31		E8	28	\$8.16	
773 33		E10	28	\$8.16	
773 35		E12	28	\$8.16	
773 37		E14	28	\$8.16	



**773 TORX® External Sockets**  
1/2" Square drive socket. Heyco

Item	Icon	No.	Size	mm	Each
773 41		E12	37	\$10.94	
773 43		E14	37	\$10.94	
773 45		E16	37	\$10.94	
773 47		E18	37	\$10.94	
773 49		E20	37	\$10.94	
773 53		E24	40	\$10.94	



**773 90 22 pc. TORX® Set Heyco**  
1/4" Drive Socket Ratchet 5.5", extension 2" & 4", swivel and hand driver in steel box. Chrome plated & polished. Heyco

Item No.	Icon	lbs.	Set includes the following:
773 90		2.14	E4, E5, E6, E7, E8, E10
\$179.98			T6, T7, T8, T9, T10, T15, T20, T25, T27, T30, T40



**713 Hex Sockets. 1/4" Square drive socket.** Replaceable bit. 1/4" bits CVM steel

Item	Icon	No.	Size	mm	Each
713 71		1/16	38	\$3.98	
713 70		5/64	38	\$3.98	
713 72		3/32	38	\$3.98	
713 74		7/64	38	\$3.98	
713 76		1/8	38	\$3.98	
713 78		9/64	38	\$3.98	
713 80		5/32	38	\$3.98	
713 82		3/16	38	\$3.98	
713 84		7/32	38	\$3.98	
713 86		1/4	38	\$3.98	

**713 Hex Sockets. 3/8" Square drive socket.** Replaceable bit. 1/4" bits CVM tool steel

Item	Icon	No.	Size	mm	Each
713 75		1/8	42	\$4.98	
713 77		9/64	42	\$4.98	
713 79		5/32	42	\$4.98	
713 81		3/16	42	\$4.98	
713 83		7/32	42	\$4.98	
713 85		1/4	42	\$4.98	
713 88		5/16	42	\$5.98	
713 90		3/8	42	\$5.98	



Made in Germany

www.wihatools.com

**Wiha Sockets**



**713 Hex Metric Sockets** 1/4" Square drive socket. Replaceable bit. 1/4" bits CVM steel

Item	No.	Size	mm	Each
	713 01	1.5	38	\$3.98
	713 02	2.0	38	\$3.98
	713 05	2.5	38	\$3.98
	713 13	3.0	38	\$3.98
	713 14	4.0	38	\$3.98
	713 17	5.0	38	\$3.98
	713 19	6.0	38	\$3.98



**713 Hex Metric Sockets** 3/8" Square drive socket. Replaceable bit. 1/4" bits CVM steel

Item	No.	Size	mm	Each
	713 31	4.0	38	\$4.98
	713 23	5.0	38	\$4.98
	713 25	6.0	38	\$4.98
	713 20	8.0	38	\$5.98
	713 22	10.0	38	\$5.98



**771 Slotted Sockets.** 1/4" Drive 6" Long Bit Socket

Item	No.	Size	Inch	Each
	771 02	3.0	6	\$6.48
	771 04	4.0	6	\$6.48
	771 06	4.5	6	\$6.48
	771 08	5.0	6	\$6.48
	771 10	6.0	6	\$6.48
	771 12	6.5	6	\$6.48
	771 14	8.0	6	\$6.48



**771 Phillips Sockets** 1/4" Drive 6" Long Bit Socket

Item	No.	Size	Inch	Each
	771 16	1	6	\$6.48
	771 18	2	6	\$6.48
	771 20	3	6	\$6.48



**771 Pozidriv® Sockets.** 1/4" Drive 6" Long Bit Socket

Item	No.	Size	Inch	Each
	771 22	1	6	\$6.48
	771 24	2	6	\$6.48
	771 26	3	6	\$6.48



**771 Hex Inch Sockets.** 1/4" Drive 6" Long Bit Socket

Item	No.	Size	Inch	Each
	771 28	3/32	6	\$6.48
	771 30	7/64	6	\$6.48
	771 32	1/8	6	\$6.48
	771 34	9/64	6	\$6.48
	771 36	5/32	6	\$6.48
	771 38	3/16	6	\$6.48



**771 Hex Metric Sockets.** 1/4" Drive 6" Long Bit Socket

Item	No.	Size	Inch	Each
	771 40	2.5	6	\$6.48
	771 42	3.0	6	\$6.48
	771 44	4.0	6	\$6.48
	771 46	5.0	6	\$6.48
	771 48	6.0	6	\$6.48



**771 TORX® Sockets.** 1/4" Drive 6" Long Bit Socket

Item	No.	Size	Inch	Each
	771 52	T10	6	\$6.98
	771 54	T15	6	\$6.98
	771 56	T20	6	\$6.98
	771 58	T25	6	\$6.98
	771 60	T27	6	\$6.98
	771 62	T30	6	\$6.98
	771 64	T40	6	\$6.98



**771 Tamper Resistant TORX® Sockets.** 1/4" Drive 6" Long Bit Socket

Item	No.	Size	Inch	Each
	771 66	TR10	6	\$6.98
	771 68	TR15	6	\$6.98
	771 70	TR20	6	\$6.98
	771 72	TR25	6	\$6.98
	771 74	TR27	6	\$6.98
	771 76	TR30	6	\$6.98



**713 94 5 pc. Hex Metric Socket Set**  
Item No. 713 94 lbs. Set includes the following:  
.00 Hex Metric: 4.0, 5.0, 6.0, 8.0, 10.0mm  
Each \$26.90





Made in Germany

Toll Free: (800) 494-6104

**Wiha Socket Sets On Molded Rails**



**761 91 10 pc. TORX® Socket Set**  
1/4" Square Drive Replaceable Bit Socket. Bits CVM tool steel.  
OAL 1.5"  
Item No.   
**761 91** lbs. **Set includes the following:**  
Each .48 T7, T8, T9, T10, T15,  
\$39.98 T20, T25, T27, T30, T40



**763 95 8 pc. TORX® Socket Set**  
3/8" Square Drive Replaceable Bit Socket. Bits CVM tool steel.  
OAL 1.5"  
Item No.   
**763 95** lbs. **Set includes the following:**  
Each .75 T9, T10, T15, T20, T25,  
\$32.98 T27, T30, T40



**763 96 8 pc. TORX® Socket Set**  
3/8" Square Drive Replaceable Bit Socket. 1/4" & 5/16" Bits CVM tool steel. OAL 1.65"  
Item No.   
**763 96** lbs. **Set includes the following:**  
Each .84 1/4": T20, T25, T27, T30, T40,  
\$39.98 5/16": T45, T50, T55



Security Torx®



**701 95 10 pc. Tamper Resistant TORX® Socket Set** 1/4" Square drive replaceable bit socket. 1/4" Bits CVM tool steel.  
Item No.   
**701 95** lbs. **Set includes the following:**  
Each .48 TR7, TR8, TR9, TR10, TR15,  
\$48.98 TR20, TR25, TR27, TR30, TR40



**713 91 10 pc. Hex Inch Socket Set**  
1/4" Square drive replaceable bit socket. Bits CVM tool steel.  
OAL 1.5"  
Item No.   
**713 91** lbs. **Set includes the following:**  
Each .48 1/16, 5/64, 3/32, 7/64, 1/8  
\$39.98 9/64, 5/32, 3/16, 7/32, 1/4"



**713 92 8 pc. Hex Inch Socket Set**  
3/8" Square Drive Replaceable Bit Socket. 1/4" Bits CVM tool steel.  
OAL 1.65"  
Item No.   
**713 92** lbs. **Set includes the following:**  
Each .78 1/8, 9/64, 5/32, 3/16, 7/32,  
\$36.98 1/4, 5/16, 3/8"



**719 96 9 pc. Hex Metric Socket Set**  
1/4" & 3/8" Square Drive Replaceable Bit Socket. 1/4" Bits CVM tool steel. OAL 1.65"  
Item No.   
**719 96** lbs. **Set includes the following:**  
Each .65 1/4": 1.5, 2.0, 2.5, 3.0, 4.0mm  
\$39.98 3/8": 5.0, 6.0, 8.0, 10.0mm



**773 91 8 pc. E-TORX® Socket Set**  
Item No.   
**773 91** lbs. **Set includes the following:**  
.62 1/4" drive: E6, E7, E8, E10  
Each 3/8" drive: E12, E14  
\$57.98 1/2" drive: E16, E18









Made in Germany

Toll Free: (800) 494-6104

Numerical Index by Item Number

Table with 12 columns: Item No., Page, Each, Item No., Page, Each, Item No., Page, Each, Item No., Page, Each, Item No., Page, Each, Item No., Page, Each. It lists various tools and their pricing details.



