



LOW PROFILE, THREE FLANGE 6VA POWER TRANSFORMER APPROVED TO UL506 AND CSA C22.2 NO. 66-1988 AND USES A UL CLASS B (130°C) APPROVED INSULATION SYSTEM

MODEL NUMBER
3FL & PF 6VA

REV. Status
REVISION -
05/01/07 YS

A. Electrical Specifications (@25°C)

1. Maximum Power: 6VA
2. Primary Voltage and Frequency: 115/230VAC
50/60Hz.
3. Secondary RMS Rating: See Table A on sheet 2
4. voltage Regulation: 35% TYP @ full load to no load
5. Temperature Rise: 45°C TYP (60°C MAX)
6. Insulation Resistance:
100MΩ MIN @ 500VDC, Pri to Sec, Pri to Core
100MΩ MIN @ 500VDC, Sec to core
7. Dielectric Withstand:
1500Vrms 1 minute @ Pri to Sec, Pri to Core
1500Vrms 1 minute @ Sec to Core



- B. Marking: TAMURA, Tamura part number (see sheet 2)
MICROTRAN, Microtran part number (see sheet 2)
date code, country of origin, safety logos
and input and output ratings (see sheet 2)

C. Safety:

UL approved, UL506 File E145619, E79781
Insulation Class B (130°C) File No E92957
CSA Certified, C22.2 No. 66 File 081383
(3FL Series)

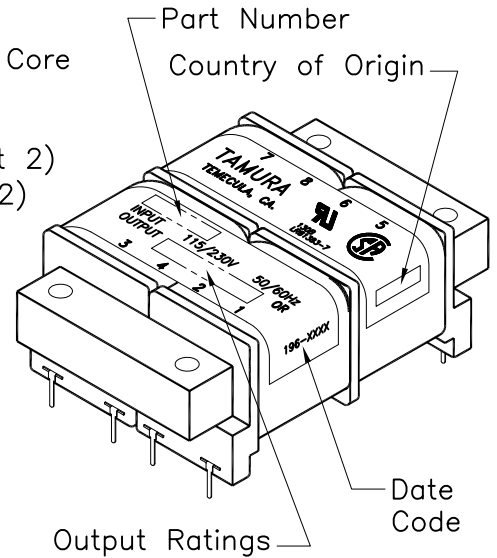

D. Mechanical Specifications:

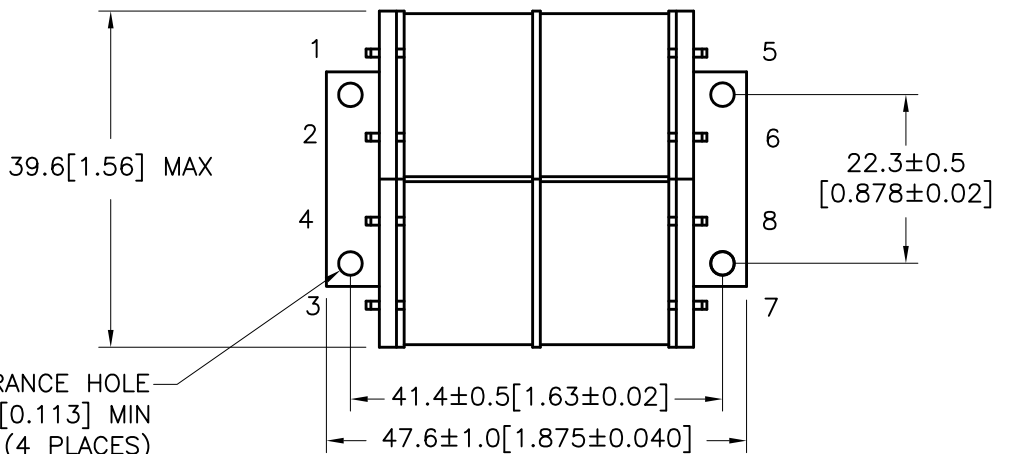
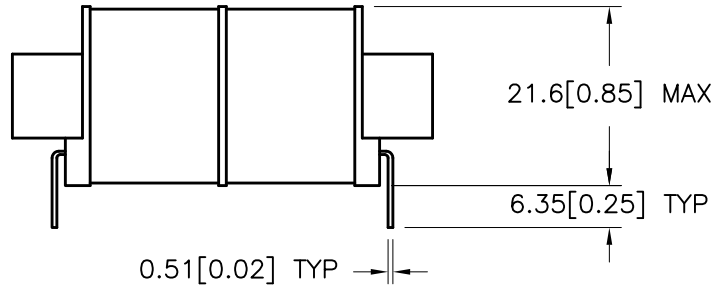
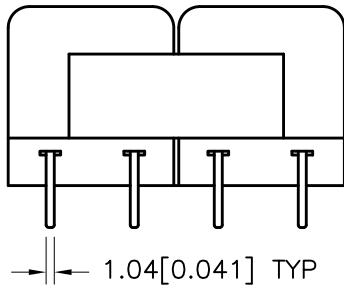

TOLERANCES (mm)	
≤ 4	± 0.2
4 ≤ 20	± 0.3
20 ≤ 50	± 0.4

PREPARED BY:
K. BRENNAN

ENGINEER:
M. PITCHAI

SAFETY ENGINEER
B OCONNELL

APPROVED:
Y. SEKIGUCHI

DWG CONTROL NO. P-A1-11599
ACAD\3F\A1115991.DWG

CONTENTS OF THIS DRAWING ARE SUBJECT TO CHANGE WITHOUT PRIOR NOTICE

PROPRIETARY NOTICE: THIS DRAWING PRINT OR DOCUMENT AND SUBJECT MATTER DISCLOSED HEREIN ARE PROPRIETARY ITEMS TO WHICH TAMURA RETAINS THE EXCLUSIVE RIGHT OF DISSEMINATION, REPRODUCTION, MANUFACTURE AND SALE. THIS DRAWING, PRINT OR DOCUMENT IS SUBMITTED IN CONFIDENCE FOR CONSIDERATION BY THE RECIPIENT ALONE UNLESS PERMISSION FOR FURTHER DISCLOSURE IS EXPRESSLY GRANTED IN WRITING.

REV -
6VA 3FL & PF SERIES
POWER TRANSFORMER

TAMURA CORPORATION OF AMERICA
43352 BUSINESS PARK DRIVE, TEMECULA, CA. 92590-6624
(951) 699-1270 FAX 9516769482

3FL & PF 6VA

MODEL SPECIFICATION
DIM: mm[In] SCL: 1/1 SH: 1 OF 2

E. Mounting Footprint:

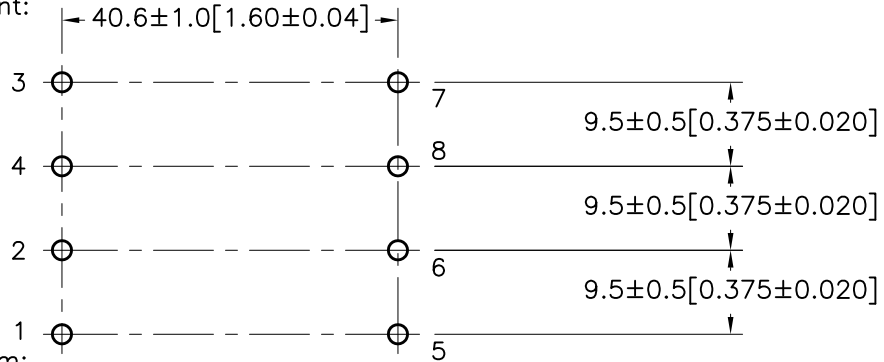

F. Schematic Diagram:

PRIMARY INPUT CONNECTIONS

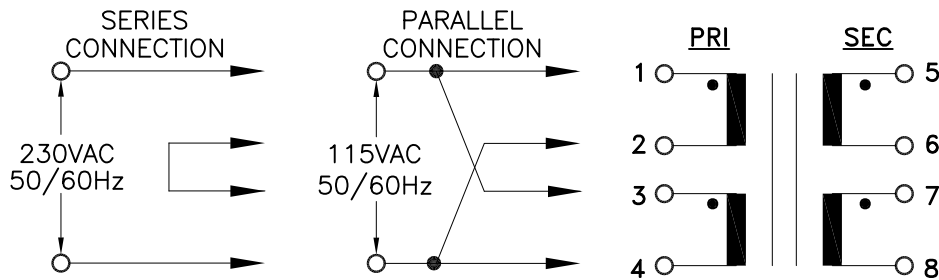

SECONDARY OUTPUT CONNECTIONS

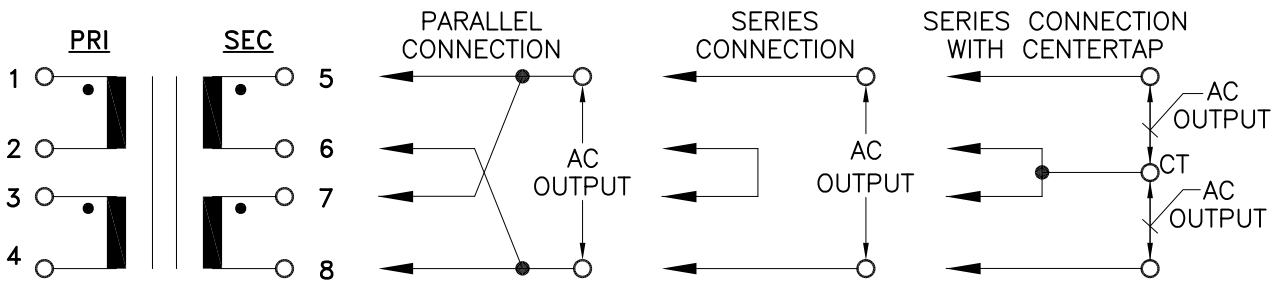

G. Table A:

TAMURA PART NO.	MICROTRAN PART NO.	PARALLEL CONNECTION		SERIES CONNECTION		SERIES CONNECTION WITH CT	
		AC VOLTS	RMS AMPS	AC VOLTS	RMS AMPS	AC VOLTS	RMS AMPS
3FL10-600	PF6-10	5.0	1.20	10.0	0.600	5.0-CT-5.0	0.600
3FL12-475	PF6-12	6.3	0.95	12.6	0.475	6.3-CT-6.3	0.475
3FL16-350	PF6-16	8.0	0.70	16.0	0.350	8.0-CT-8.0	0.350
3FL20-300	PF6-20	10.0	0.60	20.0	0.300	10.0-CT-10.0	0.300
3FL24-250	PF6-24	12.0	0.50	24.0	0.250	12.0-CT-12.0	0.250
3FL30-200	PF6-30	15.0	0.40	30.0	0.200	15.0-CT-15.0	0.200
3FL34-170	PF6-34	17.0	0.34	34.0	0.170	17.0-CT-17.0	0.170
3FL40-150	N/A	20.0	0.30	40.0	0.150	20.0-CT-20.0	0.150
3FL56-100	PF6-56	28.0	0.20	56.0	0.100	28.0-CT-28.0	0.100
3FL88-65	N/A	44.0	0.13	88.0	0.065	44.0-CT-44.0	0.065
3FL120-50	N/A	60.0	0.10	120.0	0.050	60.0-CT-60.0	0.050
3FL230-25	N/A	115.0	0.05	230.0	0.025	115.0-CT-115.0	0.025

PREPARED BY:

K. BRENNAN

ENGINEER:

M. PITCHAI

SAFETY ENGINEER

B OCONNELL

APPROVED:

Y. SEKIGUCHI

DWG CONTROL NO. P-A1-11599
ACAD\3F\A115991.DWG

REV -
6VA 3FL & PF SERIES
POWER TRANSFORMER

TAMURA CORPORATION OF AMERICA
43352 BUSINESS PARK DRIVE, TEMECULA, CA. 92590-6624
(951) 699-1270 FAX 9516769482

3FL & PF 6VA

MODEL SPECIFICATION

DIM: mm[In] SCL: 1/1 SH: 2 OF 2

PROPRIETARY NOTICE: THIS DRAWING PRINT OR DOCUMENT AND SUBJECT MATTER DISCLOSED HEREIN ARE PROPRIETARY ITEMS TO WHICH TAMURA RETAINS THE EXCLUSIVE RIGHT OF DISSEMINATION, REPRODUCTION, MANUFACTURE AND SALE. THIS DRAWING, PRINT OR DOCUMENT IS SUBMITTED IN CONFIDENCE FOR CONSIDERATION BY THE RECIPIENT ALONE UNLESS PERMISSION FOR FURTHER DISCLOSURE IS EXPRESSLY GRANTED IN WRITING.